



# Zehnder Radiadores a medida

Catálogo - Tarifa 2024\_v0924

always the best climate



# always the best climate

Nuestra misión es ofrecer un ambiente interior saludable con soluciones de máxima calidad. Nuestros radiadores y la calefacción y refrigeración por techo radiante mantienen los espacios habitables a una temperatura confortable, y nuestras soluciones de ventilación permiten respirar aire limpio fresco 24/7.

**zehnder**



## Socio de confianza

Desde 1895 ofrecemos a nuestros clientes soluciones a medida, desde la planificación hasta la instalación de excelentes soluciones para el mejor ambiente interior.



## Saber qué viene después

El motor de nuestro negocio ha sido siempre el enfoque continuo en la innovación. Nos esforzamos en ofrecer soluciones inteligentes de ventilación, calefacción y refrigeración.



## Calidad y precisión suiza

Todos nuestros productos reflejan una calidad y precisión suiza. Nuestros estándares de diseño crean una elegancia atemporal en los espacios habitables de ayer, hoy y mañana.



## Saber por qué, saber cómo

Nuestra misión permanente es compartir con nuestros clientes la experiencia y los conocimientos mediante una formación competente. Las academias Zehnder especializadas dan vida al ambiente interior.



*Dr. Hans-Peter Zehnder & Milva Inderbitzin-Zehnder*

## De un negocio familiar a una empresa internacional

De un pequeño taller mecánico familiar en Gränichen, Suiza, Zehnder se ha convertido en una compañía líder internacional. Las raíces de la empresa están estrechamente vinculadas con el espíritu empresarial de la familia Zehnder. La cultura corporativa de Zehnder se basa en la orientación al cliente, el respeto, la confianza, la curiosidad y la transparencia.

# Su socio global para el ambiente interior

**4.000**  
empleados

**16**  
plantas de  
producción

más de  
**1.400**  
patentes y diseños  
registrados



presencia  
global en  
más de  
**70**  
países

**25k** clientes  
formados  
al año



## Radiadores de diseño

Nuestros radiadores de diseño crean un hogar acogedor y tienen diseños atractivos.

## Ventilación confortable de interiores

Nuestros sistemas de ventilación garantizan un ambiente interior saludable, funcionan con una eficiencia energética elevada, aumentan el bienestar y mantienen el valor adecuado.

## Calefacción y refrigeración por techo radiante

Nuestros sistemas de calefacción y refrigeración por techo radiante son energéticamente eficaces y versátiles para adaptarse a distintos entornos.

## Purificación industrial de aire

Nuestras soluciones de aire limpio transforman los entornos de trabajo y mejoran el rendimiento de las empresas en todo el mundo.

# 127 años de espíritu pionero

Fundada en 1895 por Jakob Zehnder, como un taller mecánico en Gränichen, en el cantón de Aargau, Zehnder se ha convertido en un grupo internacional de empresas.

La visión empresarial de la familia propietaria ha sido decisiva para el éxito de la productora suiza junto con el espíritu pionero y el coraje de los empleados, que han buscado constantemente nuevas soluciones orientadas al cliente para satisfacer las diversas necesidades del mercado.

#### Cultura corporativa caracterizada por el espíritu de innovación

Mirando hacia atrás, Zehnder tiene una cultura corporativa caracterizada por la diversificación y el espíritu de innovación. Desde la producción de la motocicleta ligera “Zehnderli” y el desarrollo del Zehnder Charleston, el primer radiador de acero tubular del mundo, hasta su entrada en el negocio de la ventilación, Zehnder siempre ha tenido una visión de futuro. Hasta el día de hoy, el sello distintivo de la cultura corporativa de Zehnder es planificar y actuar teniendo en cuenta la sostenibilidad y el largo plazo, a la vez que reconoce y aprovecha las oportunidades.

#### Asumir la responsabilidad del futuro

Una de las mayores oportunidades comerciales actuales es enfrentar los desafíos globales en un mundo cada vez más volátil y complejo. Los ejecutivos de Zehnder están convencidos de que centrarse en el desempeño ambiental, social y de gobierno (ESG), mientras se adopta la responsabilidad social corporativa (RSC), proporcionará a la empresa un éxito comercial a largo plazo. A lo largo de su historia, Zehnder Group ha demostrado que es capaz de adaptarse bien a las circunstancias externas, demostrando continuamente flexibilidad y resiliencia.



La casa de Jakob Zehnder con un pequeño taller mecánico

1895



Nace la empresa familiar

1912

1930

Primer radiador de tubo de acero de Europa



1964

Inicio de la expansión global

2007

Nuevo negocio: soluciones de aire limpio

2001

Entramos en el negocio de la ventilación



2013

Inauguración del centro logístico en Lahr (Alemania)



1996

Primera planta de producción en China



2022

Un proveedor internacional líder de soluciones completas para un clima interior saludable

1979

Nuestro primer radiador toallero de baño

1986

Cotización en el mercado de valores suizo

1980

Producción de paneles de techo radiante



1923

Una motocicleta ligera conquista Suiza



**Haciendo historia,  
creando el futuro**

*Desde 1895*





## Profesional, estamos cerca de ti

Conectados para afrontar cualquier proyecto.  
Asegurando nuestro compromiso de servicio y ofreciendo las mejores soluciones.

### Siéntenos cerca

Delegación Norte

Delegación Oeste y Portugal

Delegación Este (Andorra e Islas Baleares)

Delegación Centro y Sur

**Oficinas Centrales BCN**  
Raimon Casellas 131  
08025 Sabadell  
Barcelona

**Oficinas MAD**  
Torre Realía  
Paseo de la Castellana 216, P8  
28046 Madrid

### Instalador, te formamos y estamos a tu lado

<b>+50</b> instaladores autorizados	<b>+2000</b> instaladores formados	<b>+100</b> distribuidores especializados
--	---------------------------------------	--

El equipo de formación de Zehnder realiza sesiones personalizadas y a medida adaptadas a tus necesidades y a las de tu equipo. Nos adaptamos a ti, sesiones online o presenciales (a consultar) según tu localización.

Contacta con nosotros y cuéntanos que necesitas al: [formacion.zges@zehndergroup.com](mailto:formacion.zges@zehndergroup.com)

### Ciente, la confianza te la aporta Zehnder

**zehnder SERVICE**

EFICAZ

RÁPIDO

SAT OFICIAL

CERCA

### Contacta con nosotros

+34 900700110    [info@zehnder.es](mailto:info@zehnder.es)

**142**    **37**    **27**

Buscanos en las redes  
Zehnder Group Ibérica

# 5 ambientes de color para una infinita inspiración

Mundos de color únicos para cualquier habitación del hogar basados en tendencias de diseño de interiores a largo plazo, orientados al futuro.

## Zehnder World of Colours



Escanea para descubrir

**Sanctuary**  
Haz de tu hogar un lugar  
de paz y relajación



**The Mystical Home**  
Un espacio con poca luz  
para rituales y bienestar





Cada uno de los ambientes refleja las tendencias actuales de color y estilo en el contexto de una arquitectura innovadora como una forma de visualizar el potencial de la creatividad.

Ver la nueva carta de colores World of Colours en las páginas 10 -11.

### Neo Green

Reflejos del encanto de un entorno natural



### Mother Earth

Terracotta como símbolo de calidez



### Mono Material Concrete

La continuidad del espacio: pureza, fluidez, expresión

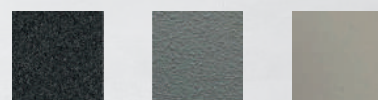

# Un mundo de colores

## Colores calidos

### CORE

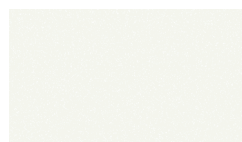

**White Quartz**  
0521

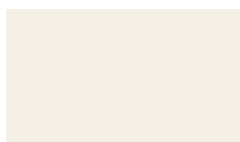

**Pure White**   
RAL 9010 / 9010

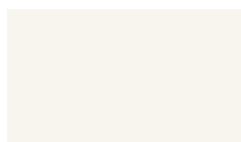

**Edelweiss**  
0067

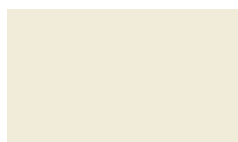

**Cream**   
RAL 9001 / 9001



**Telegrey 4**  
RAL 7047 / 7247



**Beige Quartz**  
0523



**Golden Sand**  
0258



**Yellow Grey**  
RAL 7034 / 7234



**Pearl Beige**  
RAL 1035 / 1235



**Beach Gold**  
0272



**Concrete Grey**  
0265

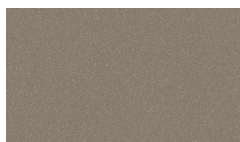

**Beige Grey**  
0267

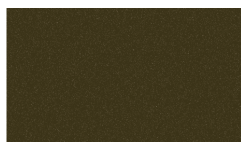

**Bronze**  
0276

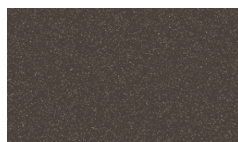

**Brown Quartz**  
0529



**Dark Brown**  
0270

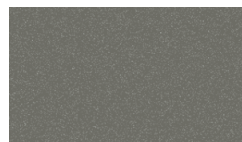

**Grey Aluminium**   
9007



**Anthracite**   
0346

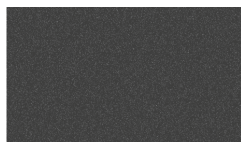

**Umbra Grey**  
RAL 7022 / 7222

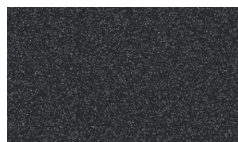

**Volcanic**   
0336

### TREND

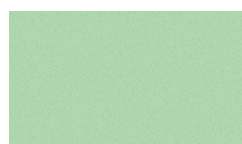

**Pastel Green**  
RAL 6019 / 6219



**Reseda Green**  
RAL 6011 / 6211



**Cement Grey**  
RAL 7033 / 7233



**Olive Green**  
RAL 6003 / 6203



**Terracotta Faded**  
0299



**Terracotta**  
0292



**Ruby Red**   
RAL 3003 / 3003

# Colores fríos

## CORE

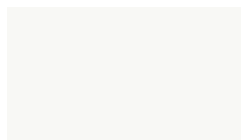

**White Matt**  
0556

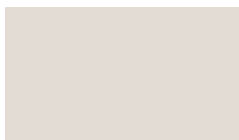

**Light Beige**  
0253



**Light Grey**  
0262

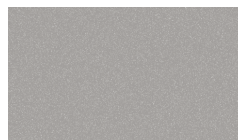

**White Aluminium**   
9006

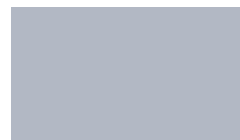

**Light Jeans**  
0264

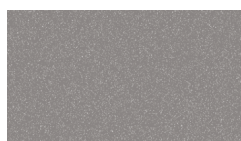

**Titane**   
0335

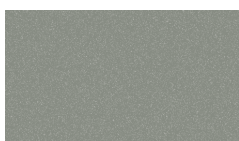

**Inox Look**   
0332



**Telegrey 2**  
RAL 7046 / 7246



**Blue Grey**  
RAL 7031 / 7231



**Anthracite Grey**   
RAL 7016 / 7016



**Black Quartz**  
0550

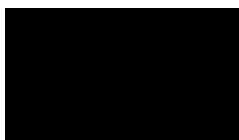

**Black Matt**  
0557

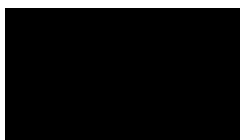

**Traffic Black**  
RAL 9017 / 9217

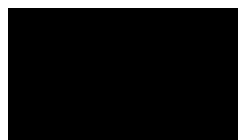

**Jet Black**   
RAL 9005 / 9005

## TREND



**Pastel Blue**  
RAL 5024 / 5224



**Pigeon Blue**  
RAL 5014 / 5214



**Gentian Blue**  
RAL 5010 / 5210



**Sapphire Blue**  
RAL 5003 / 5203



**Blue Night**  
0289

## ACABADOS

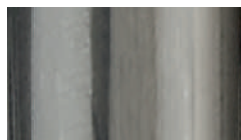

**Technoline (Barniz)**   
0325



**Cromado (superficie)**  
0008



**Acero inoxidable cepillado**  
9517

## STANDARD



**Traffic White**   
RAL 9016 / 9016

## NOTAS

 Estos colores tienen un acabado brillante; todos los demás colores tienen un acabado mate.

Algunos colores y acabados solo están disponibles para algunos productos seleccionados. Los códigos RAL son descripciones del fabricante. Otros colores de carta disponibles bajo pedido. Consultar.

A pesar del cuidado máximo con el que se ha producido esta carta de colores, así como en el proceso de pintado de nuestros radiadores, el color puede sufrir ligeras variaciones con respecto a esta carta, dependiendo de la serie de producción y en comparación con otros soportes de muestra de color (cerámica, papel, metal, etc.).



**Nombre del color**  
Código

studio  
collection

# Zehnder Studio Collection

When form  
follows function



## La arquitectura está en nuestros genes

El ingeniero Egon Runté y el arquitecto Jürg Altherr fundaron Runtal en 1953. La empresa ganó reputación en el mercado suizo rápidamente y fue muy popular entre arquitectos e interioristas gracias a la combinación de productos innovadores y diseños únicos. Zehnder Group adquirió Runtal en 1988. Esta adquisición fortaleció significativamente la posición de ambas marcas como líderes del mercado en Suiza y en otros países europeos como España. Durante muchos años, ambas marcas han sido sinónimo de tecnología punta, innovación continua, diseño pionero, creatividad inagotable y excepcional experiencia en producción.

Para seguir la evolución de esta historia, el legado de Runtal continúa con la línea de diseño premium Zehnder Studio Collection. Juntos forman un fuerte vínculo que permite a Zehnder mirar al futuro con fuerza y confianza.



Zehnder  
Arteplano

Pág. 16





# Zehnder

Nuestra garantía:  
más confort, máximas  
prestaciones

Como líderes mundiales en fabricación de soluciones para el confort y la eficiencia energética en el hogar, nuestro porfolio de radiadores se adapta a cualquier proyecto, estancia o necesidad.

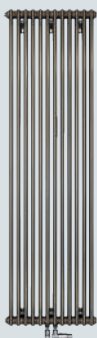

## Zehnder Charleston

Pág. 44

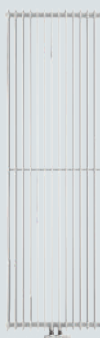

## Zehnder Excelsior

Pág. 92



## Zehnder Jet X

Pág. 126

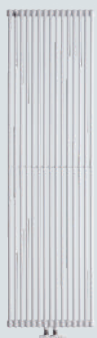

## Zehnder Kleo

Pág. 164



## Zehnder Nova

Pág. 202



## Zehnder Radiavector

Pág. 239





## Leyenda iconos

Radiador  
en versión Vertical



Un modelo con este icono significa que estamos tratando con la versión Vertical de este modelo.

Radiador  
en versión Horizontal



Un modelo con este icono significa que estamos tratando con la versión Horizontal de este modelo.

Radiador o toallero  
para agua caliente



Un modelo con este icono significa que está preparado para funcionar con una calefacción normal, normalmente con caldera (gas, gasoil, pellets, etc...) pero también con bomba de calor aire-agua.

Radiador o toallero  
Pintado



Un modelo con este icono significa que puede tener un acabado pintado, ya sea blanco estándar, en cualquier color de nuestra carta de colores o en cualquier otro color de una carta de colores oficial (Pantone, RAL, etc...).

# Zehnder Arteplano

Simplicidad y belleza





Un diseño que marca tendencia. Arteplano es una combinación perfecta de materiales, la más avanzada tecnología calefactora y un lenguaje formal atemporal. Los diferentes acabados de la superficie –acero inoxidable, aluminio, latón o cobre– convierten a este radiador en una pieza única. Belleza y diseño para un ambiente personalizado.



# Zehnder Arteplano



# Zehnder Arteplano

## VERSIONES Y ACABADOS

Disponible en versiones simples y dobles. Orientación vertical y horizontal (ver páginas 20 y 21).

Se suministra en color blanco (RAL 9016).

Disponible en los colores de la carta Zehnder (ver página 10).

Para otros colores o acabados, consultar.

Los radiadores Arteplano a medida no disponen de acabados especiales. Para acabados especiales, consultar los modelos estándar.

### Ejecuciones especiales

Radiadores en ángulo.

Radiadores curvos.

Radiadores con forma trapezoidal.

Longitudes o altura especiales.

Posición de racores especial y figuras de conexión distintas (ver página 42).

Alta presión.

Soportes de pie, de empotrar y soldados a consultar.

Separador de ambientes.

Todas las ejecuciones especiales deben ser consultadas para verificar disponibilidad y precio.

## SOPORTES

Soportes de pared incluidos en el embalaje. En el color del radiador solo con el pedido inicial.

Otros soportes de pie, de empotrar, soldados, disponibles bajo pedido (ver página 43).

### Kit de soportes a la pared adicional:

Blanco estándar (RAL 9016).

PVP **54,67 €**

## PACK DE CONEXIÓN

Incluye todas las piezas necesarias para la conexión (ver página 257).

### Bitubo. Modelos horizontales:

Para la conexión estándar.

Juego de Válvula + Detentor. Tipo B.



Tipo B

### Monotubo. Modelos horizontales:

Válvula Monotubo Horizontal. Tipo N.

Solo bajo pedido. Necesita que el radiador se fabrique especialmente.

Hay que indicar en el pedido si es derecha o izquierda. (Ver página 42).



Tipo N

### Bitubo y Monotubo. Modelos Verticales:

Válvula Mono-Bitubo de conexión inferior con entre ejes de 50 mm. Instalaciones Bitubo; *bypass* cerrado. Instalaciones Monotubo; *bypass* abierto.

Como estándar se suministra el tipo P (entrada por la derecha). El tipo Q bajo pedido. La entrada derecha-izquierda no es relevante si la válvula no es termostática.



Tipo P



Tipo Q

Tipo de válvula	Acabado	Regulación manual PVP €	Regulación termostática PVP €
Todos los tipos de válvulas	Todos los acabados	<b>202,59</b>	<b>268,14</b>

# Zehnder Arteplano

## ESPECIFICACIONES TÉCNICAS

### Versión horizontal

#### Modelos HZA

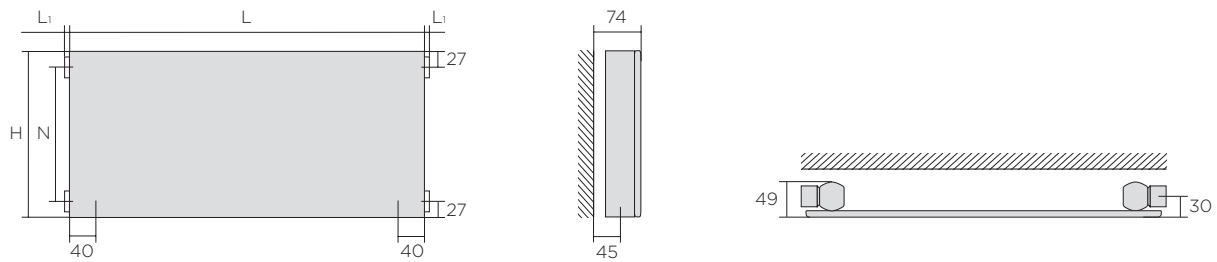

#### Modelos HZLA

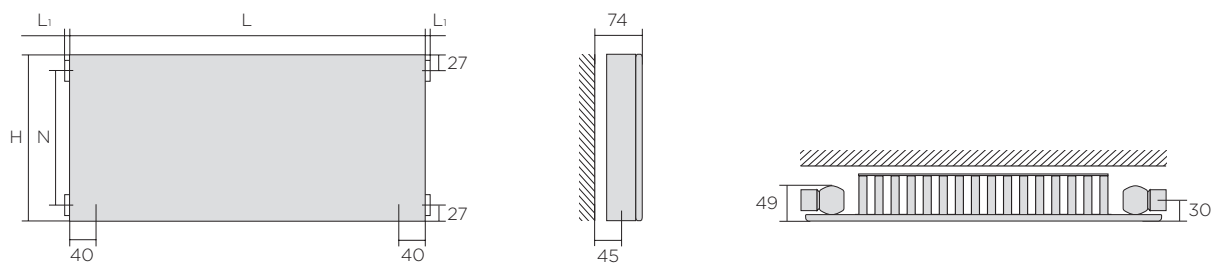

#### Modelos HZAA

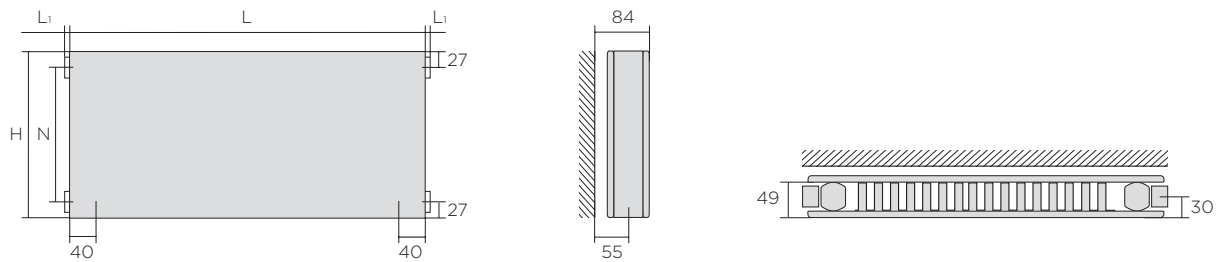

$L$  = Longitud.  $H$  = Altura.  $N$  = Distancia entre ejes.

# Zehnder Arteplano

## ESPECIFICACIONES TÉCNICAS

### Versión vertical Modelos VZA

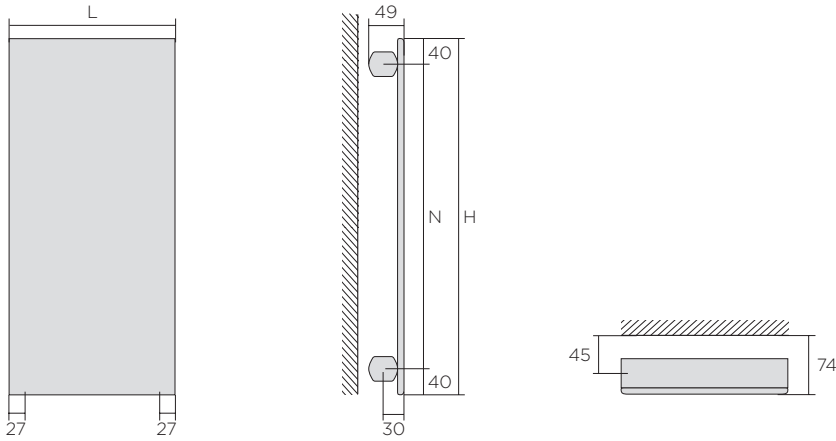

### Modelos VZLA

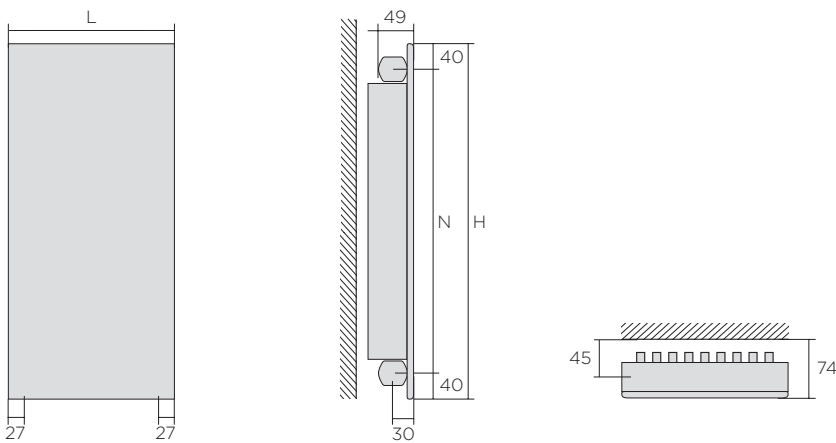

- Frontal de plancha de Acero/Aluminio/Cobre/Latón/Inox.
- Tubos ultraplano de acero de 70 x 8 mm.
- Colectores: tubos hexagonales de acero de 37 x 32 mm.
- Aletas de plancha de acero de 0,5 mm para los modelos aleteados.
- Presión máxima de servicio 4,6 bar. Presión de prueba en fábrica 6 bar.

L = Longitud. H = Altura. N = Distancia entre ejes.

# Zehnder Arteplano

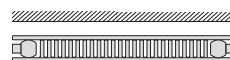
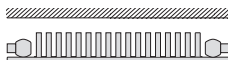
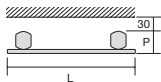
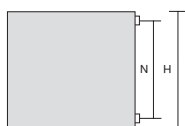

MODELO	HZA14	HZLA14/14	HZAA14/14
Altura H	157 mm	157 mm	157 mm
Entre ejes N	103 mm	103 mm	103 mm
Profundidad P	49 mm	49 mm	57 mm
Exponente n	1,24	1,24	1,26

Recuerde pedir el Pack de Conexión

Longitud L		Emisión EN 442 75/65/20 ΔT 50K W	Emisión Caldera condens. ΔT 40K W	Emisión Bomba de calor ΔT 32,5K W	Blanco RAL 9016 PVP €	Emisión EN 442 75/65/20 ΔT 50K W	Emisión Caldera condens. ΔT 40K W	Emisión Bomba de calor ΔT 32,5K W	Blanco RAL 9016 PVP €	Emisión EN 442 75/65/20 ΔT 50K W	Emisión Caldera condens. ΔT 40K W	Emisión Bomba de calor ΔT 32,5K W	Blanco RAL 9016 PVP €
Nominal mm	Real mm												
500	513	85	64	50	598,64	155	117	91	937,72	204	154	118	785,28
600	613	101	77	59	620,09	185	141	109	980,89	244	184	142	832,09
700	713	118	90	69	641,55	216	164	127	1.024,06	285	215	166	878,89
800	813	135	103	79	663,00	247	187	145	1.067,24	326	246	189	925,70
900	913	152	115	89	684,46	278	211	163	1.110,41	366	277	213	972,50
1.000	1.013	169	128	99	705,91	309	234	181	1.153,58	407	307	237	1.019,31
1.100	1.113	186	141	109	727,36	340	258	199	1.196,75	448	338	260	1.066,12
1.200	1.213	203	154	119	748,82	371	281	217	1.239,92	488	369	284	1.112,92
1.300	1.313	220	167	129	770,27	402	305	235	1.283,10	529	399	307	1.159,73
1.400	1.413	237	179	139	791,73	433	328	254	1.326,27	570	430	331	1.206,53
1.500	1.513	254	192	149	813,18	464	351	272	1.369,44	611	461	355	1.253,34
1.600	1.613	270	205	158	834,63	494	375	290	1.412,61	651	492	378	1.300,15
1.700	1.713	287	218	168	856,09	525	398	308	1.455,78	692	522	402	1.346,95
1.800	1.813	304	231	178	877,54	556	422	326	1.498,96	733	553	426	1.393,76
1.900	1.913	321	243	188	899,00	587	445	344	1.542,13	773	584	449	1.440,56
2.000	2.013	338	256	198	920,45	618	469	362	1.585,30	814	614	473	1.487,37
2.200	2.213	372	282	218	963,36	680	515	398	1.671,64	895	676	520	1.580,98
2.400	2.413	406	308	238	1.006,27	742	562	435	1.757,99	977	737	568	1.674,59

Precios para color blanco estándar RAL 9016.

Precios para carta de colores Zehnder +25%. Otros colores, consultar.



# Zehnder Arteplano

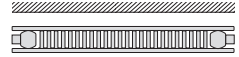
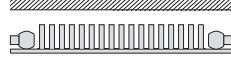
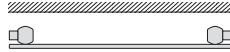
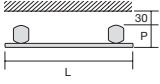
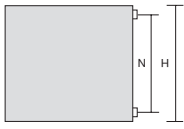

MODELO	HZA021	HZLA21/21	HZAA21/21
Altura H	231 mm	231 mm	231 mm
Entre ejes N	177 mm	177 mm	177 mm
Profundidad P	49 mm	49 mm	57 mm
Exponente n	1,25	1,27	1,29

Recuerde pedir el Pack de Conexión

Longitud L		Emisión EN 442 75/65/20 ΔT 50K W	Emisión Caldera condens. ΔT 40K W	Emisión Bomba de calor ΔT 32,5K W	Blanco RAL 9016 PVP €	Emisión EN 442 75/65/20 ΔT 50K W	Emisión Caldera condens. ΔT 40K W	Emisión Bomba de calor ΔT 32,5K W	Blanco RAL 9016 PVP €	Emisión EN 442 75/65/20 ΔT 50K W	Emisión Caldera condens. ΔT 40K W	Emisión Bomba de calor ΔT 32,5K W	Blanco RAL 9016 PVP €
Nominal mm	Real mm												
500	513	120	91	70	649,51	212	159	122	957,66	276	207	158	793,41
600	613	144	109	84	668,28	254	191	147	1.004,81	331	248	190	841,85
700	713	168	127	98	687,06	296	223	171	1.051,96	386	289	221	890,29
800	813	192	145	112	705,84	338	255	196	1.099,12	441	331	253	938,72
900	913	216	163	126	724,61	381	287	220	1.146,27	496	372	284	987,16
1.000	1.013	240	182	140	743,39	423	319	245	1.193,42	551	413	316	1.035,60
1.100	1.113	264	200	154	762,17	465	350	269	1.240,57	606	454	348	1.084,04
1.200	1.213	288	218	168	780,94	508	382	294	1.287,72	661	496	379	1.132,48
1.300	1.313	312	236	182	799,72	550	414	318	1.334,88	716	537	411	1.180,91
1.400	1.413	336	254	196	818,50	592	446	343	1.382,03	771	578	443	1.229,35
1.500	1.513	360	272	210	837,28	635	478	367	1.429,18	827	620	474	1.277,79
1.600	1.613	384	291	224	856,05	677	510	392	1.476,33	882	661	506	1.326,23
1.700	1.713	408	309	238	874,83	719	542	416	1.523,48	937	702	537	1.374,67
1.800	1.813	432	327	252	893,61	761	574	441	1.570,64	992	744	569	1.423,10
1.900	1.913	456	345	266	912,38	804	605	465	1.617,79	1.047	785	601	1.471,54
2.000	2.013	480	363	280	931,16	846	637	490	1.664,94	1.102	826	632	1.519,98
2.200	2.213	528	399	308	968,71	931	701	538	1.759,24	1.212	909	695	1.616,86
2.400	2.413	576	436	336	1.006,27	1.015	765	587	1.853,55	1.322	992	759	1.713,73

Precios para color blanco estándar RAL 9016.

Precios para carta de colores Zehnder +25%. Otros colores, consultar.

# Zehnder Arteplano

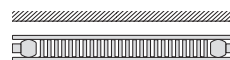
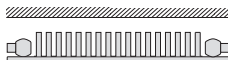
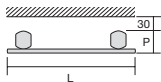
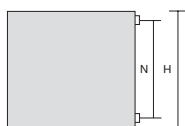

MODELO	HZA028	HZLA28/28	HZAA28/28
Altura H	305 mm	305 mm	305 mm
Entre ejes N	251 mm	251 mm	251 mm
Profundidad P	49 mm	49 mm	57 mm
Exponente n	1,24	1,27	1,30

Recuerde pedir el Pack de Conexión

Longitud L		Emisión EN 442 75/65/20 ΔT 50K W	Emisión Caldera condens. ΔT 40K W	Emisión Bomba de calor ΔT 32,5K W	Blanco RAL 9016 PVP €	Emisión EN 442 75/65/20 ΔT 50K W	Emisión Caldera condens. ΔT 40K W	Emisión Bomba de calor ΔT 32,5K W	Blanco RAL 9016 PVP €	Emisión EN 442 75/65/20 ΔT 50K W	Emisión Caldera condens. ΔT 40K W	Emisión Bomba de calor ΔT 32,5K W	Blanco RAL 9016 PVP €
Nominal mm	Real mm												
500	513	155	118	91	765,11	259	195	150	987,85	338	253	193	929,10
600	613	186	141	109	788,00	311	234	180	1.038,98	405	303	231	988,20
700	713	217	165	127	810,89	363	273	210	1.090,11	473	354	270	1.047,31
800	813	248	188	145	833,78	414	312	240	1.141,25	540	404	308	1.106,42
900	913	279	212	164	856,68	466	351	270	1.192,38	608	455	347	1.165,53
1.000	1.013	310	235	182	879,57	518	390	300	1.243,51	675	505	386	1.224,64
1.100	1.113	341	259	200	902,46	570	429	330	1.294,64	743	556	424	1.283,75
1.200	1.213	372	282	218	925,36	622	468	360	1.345,77	810	606	463	1.342,86
1.300	1.313	403	306	236	948,25	673	507	390	1.396,91	878	657	501	1.401,97
1.400	1.413	434	329	254	971,14	725	546	420	1.448,04	945	707	540	1.461,08
1.500	1.513	465	353	273	994,04	777	585	450	1.499,17	1.013	758	578	1.520,19
1.600	1.613	496	376	291	1.016,93	829	624	480	1.550,30	1.080	808	617	1.579,29
1.700	1.713	527	400	309	1.039,82	881	663	510	1.601,43	1.148	859	655	1.638,40
1.800	1.813	558	423	327	1.062,71	932	702	540	1.652,57	1.215	909	694	1.697,51
1.900	1.913	589	447	345	1.085,61	984	741	569	1.703,70	1.283	960	733	1.756,62
2.000	2.013	620	470	363	1.108,50	1.036	780	599	1.754,83	1.350	1.010	771	1.815,73
2.200	2.213	682	517	400	1.154,29	1.140	858	659	1.857,09	1.485	1.111	848	1.933,95
2.400	2.413	744	564	436	1.200,07	1.243	936	719	1.959,36	1.620	1.212	925	2.052,17

Precios para color blanco estándar RAL 9016.

Precios para carta de colores Zehnder +25%. Otros colores, consultar.





# Zehnder Arteplano

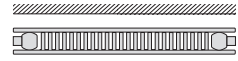
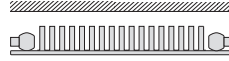
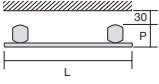
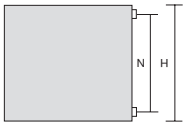

MODELO	HZA035	HZLA35/35	HZAA35/35
Altura H	379 mm	379 mm	379 mm
Entre ejes N	325 mm	325 mm	325 mm
Profundidad P	49 mm	64 mm	57 mm
Exponente n	1,24	1,28	1,31

Recuerde pedir el Pack de Conexión

Longitud L		Emisión EN 442 75/65/20 ΔT 50K W	Emisión Caldera condens. ΔT 40K W	Emisión Bomba de calor ΔT 32,5K W	Blanco RAL 9016 PVP €	Emisión EN 442 75/65/20 ΔT 50K W	Emisión Caldera condens. ΔT 40K W	Emisión Bomba de calor ΔT 32,5K W	Blanco RAL 9016 PVP €	Emisión EN 442 75/65/20 ΔT 50K W	Emisión Caldera condens. ΔT 40K W	Emisión Bomba de calor ΔT 32,5K W	Blanco RAL 9016 PVP €
Nominal mm	Real mm												
500	513	189	143	111	762,09	341	256	196	1.018,06	393	293	224	1.048,18
600	613	227	172	133	795,35	409	307	235	1.073,17	472	352	268	1.114,68
700	713	265	201	155	828,61	477	358	275	1.128,28	550	411	313	1.181,18
800	813	302	229	177	861,86	545	409	314	1.183,39	629	469	358	1.247,69
900	913	340	258	199	895,12	613	461	353	1.238,51	707	528	402	1.314,19
1.000	1.013	378	287	222	928,38	681	512	392	1.293,62	786	587	447	1.380,69
1.100	1.113	416	315	244	961,64	749	563	432	1.348,73	865	645	492	1.447,19
1.200	1.213	454	344	266	994,90	817	614	471	1.403,85	943	704	536	1.513,69
1.300	1.313	491	373	288	1.028,15	885	665	510	1.458,96	1.022	763	581	1.580,20
1.400	1.413	529	401	310	1.061,41	953	717	549	1.514,07	1.100	821	626	1.646,70
1.500	1.513	567	430	332	1.094,67	1.022	768	589	1.569,19	1.179	880	671	1.713,20
1.600	1.613	605	459	355	1.127,93	1.090	819	628	1.624,30	1.258	939	715	1.779,70
1.700	1.713	643	487	377	1.161,19	1.158	870	667	1.679,41	1.336	998	760	1.846,20
1.800	1.813	680	516	399	1.194,44	1.226	921	706	1.734,52	1.415	1.056	805	1.912,71
1.900	1.913	718	545	421	1.227,70	1.294	972	745	1.789,64	1.493	1.115	849	1.979,21
2.000	2.013	756	573	443	1.260,96	1.362	1.024	785	1.844,75	1.572	1.174	894	2.045,71
2.200	2.213	832	631	487	1.327,48	1.498	1.126	863	1.954,98	1.729	1.291	983	2.178,71
2.400	2.413	907	688	532	1.393,99	1.634	1.228	942	2.065,20	1.886	1.408	1.073	2.311,72

Precios para color blanco estándar RAL 9016.

Precios para carta de colores Zehnder +25%. Otros colores, consultar.



# Zehnder Arteplano

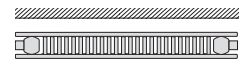
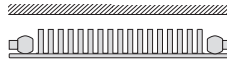
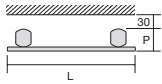
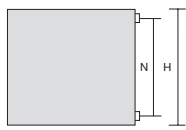

MODELO	HZA042	HZLA42/42	HZAA42/42
Altura H	453 mm	453 mm	453 mm
Entre ejes N	399 mm	399 mm	399 mm
Profundidad P	49 mm	64 mm	57 mm
Exponente n	1,24	1,29	1,33

Recuerde pedir el Pack de Conexión

Longitud L		Emisión EN 442 75/65/20 ΔT 50K W	Emisión Caldera condens. ΔT 40K W	Emisión Bomba de calor ΔT 32,5K W	Blanco RAL 9016 PVP €	Emisión EN 442 75/65/20 ΔT 50K W	Emisión Caldera condens. ΔT 40K W	Emisión Bomba de calor ΔT 32,5K W	Blanco RAL 9016 PVP €	Emisión EN 442 75/65/20 ΔT 50K W	Emisión Caldera condens. ΔT 40K W	Emisión Bomba de calor ΔT 32,5K W	Blanco RAL 9016 PVP €
Nominal mm	Real mm												
500	513	224	170	131	843,80	390	292	223	1.048,27	447	332	252	1.199,97
600	613	269	204	158	882,96	467	350	268	1.107,36	536	398	302	1.280,41
700	713	314	238	184	922,12	545	409	313	1.166,46	625	465	352	1.360,86
800	813	358	272	210	961,29	623	467	358	1.225,55	714	531	403	1.441,31
900	913	403	306	236	1.000,45	701	526	402	1.284,65	804	597	453	1.521,75
1.000	1.013	448	340	263	1.039,61	779	584	447	1.343,74	893	664	504	1.602,20
1.100	1.113	493	374	289	1.078,77	857	643	492	1.402,84	982	730	554	1.682,65
1.200	1.213	538	408	315	1.117,93	935	701	536	1.461,93	1.072	796	604	1.763,09
1.300	1.313	582	442	341	1.157,10	1.013	759	581	1.521,03	1.161	863	655	1.843,54
1.400	1.413	627	476	368	1.196,26	1.091	818	626	1.580,12	1.250	929	705	1.923,99
1.500	1.513	672	510	394	1.235,42	1.169	876	670	1.639,22	1.340	996	755	2.004,44
1.600	1.613	717	544	420	1.274,58	1.246	935	715	1.698,31	1.429	1.062	806	2.084,88
1.700	1.713	762	578	446	1.313,74	1.324	993	760	1.757,41	1.518	1.128	856	2.165,33
1.800	1.813	806	611	473	1.352,91	1.402	1.051	804	1.816,50	1.607	1.195	906	2.245,78
1.900	1.913	851	645	499	1.392,07	1.480	1.110	849	1.875,60	1.697	1.261	957	2.326,22
2.000	2.013	896	679	525	1.431,23	1.558	1.168	894	1.934,69	1.786	1.327	1.007	2.406,67
2.200	2.213	986	747	578	1.509,55	1.714	1.285	983	2.052,88	1.965	1.460	1.108	2.567,56
2.400	2.413	1.075	815	630	1.587,88	1.870	1.402	1.073	2.171,07	2.143	1.593	1.208	2.728,46

Precios para color blanco estándar RAL 9016.

Precios para carta de colores Zehnder +25%. Otros colores, consultar.



# Zehnder Arteplano

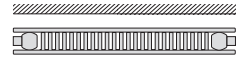
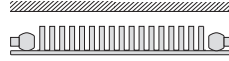
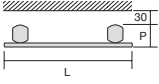
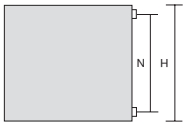

MODELO	HZA049	HZLA49/49	HZAA49/49
Altura H	527 mm	527 mm	527 mm
Entre ejes N	473 mm	473 mm	473 mm
Profundidad P	49 mm	64 mm	57 mm
Exponente n	1,25	1,30	1,34

Recuerde pedir el Pack de Conexión

Longitud L		Emisión EN 442 75/65/20 ΔT 50K W	Emisión Caldera condens. ΔT 40K W	Emisión Bomba de calor ΔT 32,5K W	Blanco RAL 9016 PVP €	Emisión EN 442 75/65/20 ΔT 50K W	Emisión Caldera condens. ΔT 40K W	Emisión Bomba de calor ΔT 32,5K W	Blanco RAL 9016 PVP €	Emisión EN 442 75/65/20 ΔT 50K W	Emisión Caldera condens. ΔT 40K W	Emisión Bomba de calor ΔT 32,5K W	Blanco RAL 9016 PVP €
Nominal mm	Real mm												
600	613	311	236	182	970,54	526	394	301	1.141,66	601	445	337	1.426,56
700	713	363	275	212	1.015,61	614	459	351	1.204,74	701	520	393	1.517,68
800	813	415	314	242	1.060,67	702	525	401	1.267,81	801	594	450	1.608,81
900	913	467	353	273	1.105,74	789	591	451	1.330,89	901	668	506	1.699,93
1.000	1.013	519	393	303	1.150,80	877	656	501	1.393,96	1.001	742	562	1.791,06
1.100	1.113	571	432	333	1.195,87	965	722	551	1.457,04	1.101	817	618	1.882,19
1.200	1.213	623	471	363	1.240,93	1.052	787	601	1.520,11	1.201	891	674	1.973,31
1.300	1.313	675	510	394	1.286,00	1.140	853	651	1.583,19	1.301	965	731	2.064,44
1.400	1.413	727	550	424	1.331,06	1.228	919	701	1.646,26	1.401	1.039	787	2.155,56
1.500	1.513	779	589	454	1.376,13	1.316	984	751	1.709,34	1.502	1.113	843	2.246,69
1.600	1.613	830	628	485	1.421,19	1.403	1.050	802	1.772,41	1.602	1.188	899	2.337,82
1.700	1.713	882	668	515	1.466,26	1.491	1.115	852	1.835,49	1.702	1.262	955	2.428,94
1.800	1.813	934	707	545	1.511,32	1.579	1.181	902	1.898,56	1.802	1.336	1.012	2.520,07
1.900	1.913	986	746	576	1.556,39	1.666	1.247	952	1.961,64	1.902	1.410	1.068	2.611,19
2.000	2.013	1.038	785	606	1.601,45	1.754	1.312	1.002	2.024,71	2.002	1.485	1.124	2.702,32
2.200	2.213	1.142	864	666	1.691,58	1.929	1.444	1.102	2.150,86	2.202	1.633	1.236	2.884,57
2.400	2.413	1.246	942	727	1.781,71	2.105	1.575	1.202	2.277,01	2.402	1.782	1.349	3.066,82

Precios para color blanco estándar RAL 9016.

Precios para carta de colores Zehnder +25%. Otros colores, consultar.

# Zehnder Arteplano

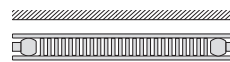
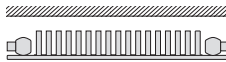
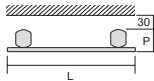
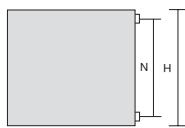

MODELO	HZA056	HZLA56/56	HZAA56/56
Altura H	601 mm	601 mm	601 mm
Entre ejes N	547 mm	547 mm	547 mm
Profundidad P	49 mm	64 mm	57 mm
Exponente n	1,25	1,31	1,35

Recuerde pedir el Pack de Conexión

Longitud L		HZA056				HZLA56/56				HZAA56/56			
Nominal mm	Real mm	Emisión EN 442 75/65/20 ΔT 50K W	Emisión Caldera condens. ΔT 40K W	Emisión Bomba de calor ΔT 32,5K W	Blanco RAL 9016 PVP €	Emisión EN 442 75/65/20 ΔT 50K W	Emisión Caldera condens. ΔT 40K W	Emisión Bomba de calor ΔT 32,5K W	Blanco RAL 9016 PVP €	Emisión EN 442 75/65/20 ΔT 50K W	Emisión Caldera condens. ΔT 40K W	Emisión Bomba de calor ΔT 32,5K W	Blanco RAL 9016 PVP €
700	713	414	313	241	1.109,14	683	510	389	1.242,94	782	579	437	1.674,53
800	813	473	358	276	1.160,11	781	583	444	1.309,99	894	661	500	1.776,34
900	913	532	402	310	1.211,07	878	656	500	1.377,05	1.005	744	562	1.878,14
1.000	1.013	591	447	345	1.262,04	976	729	555	1.444,11	1.117	826	624	1.979,95
1.100	1.113	650	492	379	1.313,01	1.074	801	611	1.511,17	1.229	909	687	2.081,76
1.200	1.213	709	537	414	1.363,97	1.171	874	666	1.578,23	1.340	992	749	2.183,56
1.300	1.313	768	581	448	1.414,94	1.269	947	722	1.645,28	1.452	1.074	812	2.285,37
1.400	1.413	827	626	483	1.465,90	1.366	1.020	777	1.712,34	1.564	1.157	874	2.387,18
1.500	1.513	887	671	517	1.516,87	1.464	1.093	833	1.779,40	1.676	1.240	937	2.488,99
1.600	1.613	946	715	552	1.567,84	1.562	1.166	888	1.846,46	1.787	1.322	999	2.590,79
1.700	1.713	1.005	760	586	1.618,80	1.659	1.239	944	1.913,52	1.899	1.405	1.062	2.692,60
1.800	1.813	1.064	805	621	1.669,77	1.757	1.312	999	1.980,57	2.011	1.488	1.124	2.794,41
1.900	1.913	1.123	850	655	1.720,73	1.854	1.384	1.055	2.047,63	2.122	1.570	1.186	2.896,21
2.000	2.013	1.182	894	690	1.771,70	1.952	1.457	1.110	2.114,69	2.234	1.653	1.249	2.998,02
2.200	2.213	1.300	984	759	1.873,63	2.147	1.603	1.221	2.248,81	2.457	1.818	1.374	3.201,63
2.400	2.413	1.418	1.073	828	1.975,56	2.342	1.749	1.332	2.382,92	2.681	1.984	1.499	3.405,25

Precios para color blanco estándar RAL 9016.

Precios para carta de colores Zehnder +25%. Otros colores, consultar.



# Zehnder Arteplano

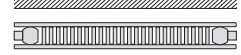
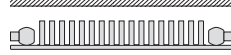
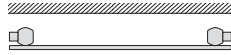
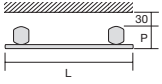
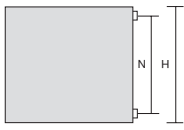

MODELO	HZA063	HZLA63/56	HZAA63/56
Altura H	675 mm	675 mm	675 mm
Entre ejes N	621 mm	621 mm	621 mm
Profundidad P	49 mm	64 mm	57 mm
Exponente n	1,25	1,31	1,35

Recuerde pedir el Pack de Conexión

Longitud L	Emisión EN 442 75/65/20 ΔT 50K W	Emisión Caldera condens. ΔT 40K W	Emisión Bomba de calor ΔT 32,5K W	Blanco RAL 9016 PVP €	Emisión EN 442 75/65/20 ΔT 50K W	Emisión Caldera condens. ΔT 40K W	Emisión Bomba de calor ΔT 32,5K W	Blanco RAL 9016 PVP €	Emisión EN 442 75/65/20 ΔT 50K W	Emisión Caldera condens. ΔT 40K W	Emisión Bomba de calor ΔT 32,5K W	Blanco RAL 9016 PVP €
700	465	352	271	1.202,67	723	540	411	1.281,07	833	616	466	1.819,94
800	531	402	310	1.259,54	826	617	470	1.352,11	952	704	532	1.930,79
900	598	452	349	1.316,41	930	694	529	1.423,15	1.071	792	599	2.041,64
1.000	664	502	388	1.373,28	1.033	771	588	1.494,19	1.190	880	665	2.152,49
1.100	730	553	426	1.430,15	1.136	848	646	1.565,23	1.309	969	732	2.263,34
1.200	797	603	465	1.487,02	1.240	925	705	1.636,27	1.428	1.057	798	2.374,19
1.300	863	653	504	1.543,89	1.343	1.003	764	1.707,31	1.547	1.145	865	2.485,04
1.400	930	703	543	1.600,76	1.446	1.080	823	1.778,35	1.666	1.233	931	2.595,89
1.500	996	754	581	1.657,63	1.550	1.157	881	1.849,39	1.785	1.321	998	2.706,74
1.600	1.062	804	620	1.714,50	1.653	1.234	940	1.920,42	1.904	1.409	1.064	2.817,59
1.700	1.129	854	659	1.771,37	1.756	1.311	999	1.991,46	2.023	1.497	1.131	2.928,44
1.800	1.195	904	698	1.828,24	1.859	1.388	1.058	2.062,50	2.142	1.585	1.197	3.039,29
1.900	1.262	955	736	1.885,11	1.963	1.465	1.116	2.133,54	2.261	1.673	1.264	3.150,14
2.000	1.328	1.005	775	1.941,98	2.066	1.542	1.175	2.204,58	2.380	1.761	1.330	3.260,99
2.200	1.461	1.105	853	2.055,72	2.273	1.697	1.293	2.346,66	2.618	1.937	1.464	3.482,69
2.400	1.594	1.206	930	2.169,46	2.479	1.851	1.410	2.488,74	2.856	2.113	1.597	3.704,39

Precios para color blanco estándar RAL 9016.

Precios para carta de colores Zehnder +25%. Otros colores, consultar.



# Zehnder Arteplano

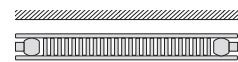
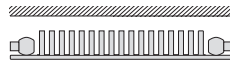
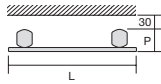
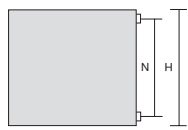

MODELO	HZA070	HZLA70/56	HZAA70/56
Altura H	749 mm	749 mm	749 mm
Entre ejes N	695 mm	695 mm	695 mm
Profundidad P	49 mm	64 mm	57 mm
Exponente n	1,25	1,31	1,35

Recuerde pedir el Pack de Conexión

Longitud L		HZA070				HZLA70/56				HZAA70/56			
Nominal mm	Real mm	Emisión EN 442 75/65/20 ΔT 50K W	Emisión Caldera condens. ΔT 40K W	Emisión Bomba de calor ΔT 32,5K W	Blanco RAL 9016 PVP €	Emisión EN 442 75/65/20 ΔT 50K W	Emisión Caldera condens. ΔT 40K W	Emisión Bomba de calor ΔT 32,5K W	Blanco RAL 9016 PVP €	Emisión EN 442 75/65/20 ΔT 50K W	Emisión Caldera condens. ΔT 40K W	Emisión Bomba de calor ΔT 32,5K W	Blanco RAL 9016 PVP €
800	813	592	448	346	1.358,96	871	650	495	1.394,30	1.010	748	565	2.084,94
900	913	666	504	389	1.421,74	980	732	557	1.469,31	1.137	841	635	2.204,81
1.000	1.013	740	560	432	1.484,51	1.089	813	619	1.544,33	1.263	934	706	2.324,68
1.100	1.113	814	616	475	1.547,28	1.198	894	681	1.619,35	1.389	1.028	777	2.444,55
1.200	1.213	888	672	518	1.610,06	1.307	976	743	1.694,36	1.516	1.121	847	2.564,42
1.300	1.313	962	728	561	1.672,83	1.416	1.057	805	1.769,38	1.642	1.215	918	2.684,29
1.400	1.413	1.036	784	605	1.735,60	1.525	1.138	867	1.844,40	1.768	1.308	988	2.804,16
1.500	1.513	1.110	840	648	1.798,38	1.634	1.219	929	1.919,42	1.895	1.402	1.059	2.924,03
1.600	1.613	1.184	896	691	1.861,15	1.742	1.301	991	1.994,43	2.021	1.495	1.130	3.043,90
1.700	1.713	1.258	952	734	1.923,92	1.851	1.382	1.053	2.069,45	2.147	1.589	1.200	3.163,77
1.800	1.813	1.332	1.008	777	1.986,69	1.960	1.463	1.115	2.144,47	2.273	1.682	1.271	3.283,64
1.900	1.913	1.406	1.064	821	2.049,47	2.069	1.545	1.177	2.219,48	2.400	1.776	1.341	3.403,51
2.000	2.013	1.480	1.120	864	2.112,24	2.178	1.626	1.239	2.294,50	2.526	1.869	1.412	3.523,38
2.200	2.213	1.628	1.232	950	2.237,79	2.396	1.789	1.363	2.444,53	2.779	2.056	1.553	3.763,12
2.400	2.413	1.776	1.344	1.037	2.363,33	2.614	1.951	1.486	2.594,57	3.031	2.243	1.695	4.002,86

Precios para color blanco estándar RAL 9016.

Precios para carta de colores Zehnder +25%. Otros colores, consultar.



# Zehnder Arteplano

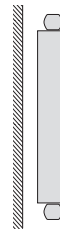
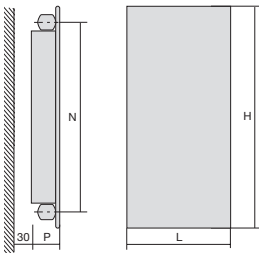

MODELO	VZA060	VZLA060
Altura H	613 mm	613 mm
Entre ejes N	533 mm	533 mm
Profundidad P	49 mm	62 mm
Exponente n	1,28	1,28

Recuerde pedir el Pack de Conexión

Elementos	Longitud L		Emisión EN 442 75/65/20 ΔT 50K W	Emisión Caldera condens. ΔT 40K W	Emisión Bomba de calor ΔT 32,5K W	Blanco RAL 9016 PVP €	Emisión EN 442 75/65/20 ΔT 50K W	Emisión Caldera condens. ΔT 40K W	Emisión Bomba de calor ΔT 32,5K W	Blanco RAL 9016 PVP €
	Nominal mm	Real mm								
2	140	157	88	66	51	513,25	132	99	76	967,48
3	210	231	132	99	76	597,72	198	149	114	1.055,33
4	280	305	176	132	101	682,19	264	198	152	1.143,18
5	350	379	220	165	127	766,66	330	248	190	1.231,03
6	420	453	264	198	152	851,13	396	298	228	1.318,88
7	490	527	308	231	177	935,60	462	347	266	1.406,73
8	560	601	352	265	203	1.020,07	528	397	304	1.494,58
9	630	675	396	298	228	1.104,54	594	446	342	1.582,43
10	700	749	440	331	254	1.189,01	660	496	380	1.670,28
11	770	823	484	364	279	1.273,48	726	546	418	1.758,13
12	840	897	528	397	304	1.357,95	792	595	456	1.845,98
13	910	971	572	430	330	1.442,42	858	645	494	1.933,83
14	980	1.045	616	463	355	1.526,89	924	694	532	2.021,68
15	1.050	1.119	660	496	380	1.611,36	990	744	570	2.109,53
16	1.120	1.193	704	529	406	1.695,83	1.056	794	608	2.197,38

Precios para color blanco estándar RAL 9016.

Precios para carta de colores Zehnder +25%. Otros colores, consultar.



# Zehnder Arteplano

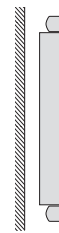
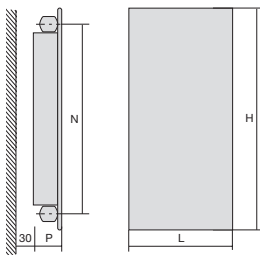

MODELO	VZA080	VZLA080
Altura H	813 mm	813 mm
Entre ejes N	733 mm	733 mm
Profundidad P	49 mm	62 mm
Exponente n	1,29	1,30

Recuerde pedir el Pack de Conexión

Elementos	Longitud L		Emisión EN 442 75/65/20 ΔT 50K W	Emisión Caldera condens. ΔT 40K W	Emisión Bomba de calor ΔT 32,5K W	Blanco RAL 9016 PVP €	Emisión EN 442 75/65/20 ΔT 50K W	Emisión Caldera condens. ΔT 40K W	Emisión Bomba de calor ΔT 32,5K W	Blanco RAL 9016 PVP €
	Nominal mm	Real mm								
2	140	157	114	85	65	546,03	166	124	95	1.036,91
3	210	231	171	128	98	642,93	249	186	142	1.132,86
4	280	305	228	171	131	739,83	332	248	190	1.228,81
5	350	379	285	214	163	836,73	415	311	237	1.324,76
6	420	453	342	256	196	933,63	498	373	284	1.420,71
7	490	527	399	299	229	1.030,53	581	435	332	1.516,66
8	560	601	456	342	262	1.127,43	664	497	379	1.612,61
9	630	675	513	385	294	1.224,33	747	559	427	1.708,56
10	700	749	570	427	327	1.321,23	830	621	474	1.804,51
11	770	823	627	470	360	1.418,13	913	683	522	1.900,46
12	840	897	684	513	392	1.515,03	996	745	569	1.996,41
13	910	971	741	556	425	1.611,93	1.079	807	616	2.092,36
14	980	1.045	798	598	458	1.708,83	1.162	869	664	2.188,31
15	1.050	1.119	855	641	490	1.805,73	1.245	932	711	2.284,26
16	1.120	1.193	912	684	523	1.902,63	1.328	994	759	2.380,21

Precios para color blanco estándar RAL 9016.

Precios para carta de colores Zehnder +25%. Otros colores, consultar.





# Zehnder Arteplano

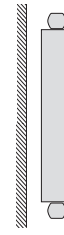
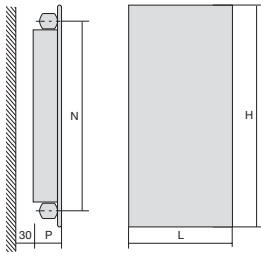

MODELO	VZA100	VZLA100
Altura H	1.013 mm	1.013 mm
Entre ejes N	933 mm	933 mm
Profundidad P	49 mm	62 mm
Exponente n	1,30	1,31

Recuerde pedir el Pack de Conexión

Elementos	Longitud L		Emisión EN 442 75/65/20 ΔT 50K W	Emisión Caldera condens. ΔT 40K W	Emisión Bomba de calor ΔT 32,5K W	Blanco RAL 9016 PVP €	Emisión EN 442 75/65/20 ΔT 50K W	Emisión Caldera condens. ΔT 40K W	Emisión Bomba de calor ΔT 32,5K W	Blanco RAL 9016 PVP €
	Nominal mm	Real mm								
2	140	157	142	106	81	578,77	200	149	114	1.002,32
3	210	231	213	159	122	688,08	300	224	171	1.106,40
4	280	305	284	212	162	797,39	400	299	227	1.210,48
5	350	379	355	266	203	906,70	500	373	284	1.314,56
6	420	453	426	319	243	1.016,01	600	448	341	1.418,64
7	490	527	497	372	284	1.125,32	700	523	398	1.522,72
8	560	601	568	425	324	1.234,63	800	597	455	1.626,80
9	630	675	639	478	365	1.343,94	900	672	512	1.730,88
10	700	749	710	531	406	1.453,25	1.000	747	569	1.834,96
11	770	823	781	584	446	1.562,56	1.100	821	626	1.939,04
12	840	897	852	637	487	1.671,87	1.200	896	682	2.043,12
13	910	971	923	691	527	1.781,18	1.300	970	739	2.147,20
14	980	1.045	994	744	568	1.890,49	1.400	1.045	796	2.251,28
15	1.050	1.119	1.065	797	608	1.999,80	1.500	1.120	853	2.355,36
16	1.120	1.193	1.136	850	649	2.109,11	1.600	1.194	910	2.459,44

Precios para color blanco estándar RAL 9016.

Precios para carta de colores Zehnder +25%. Otros colores, consultar.

# Zehnder Arteplano

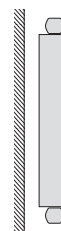
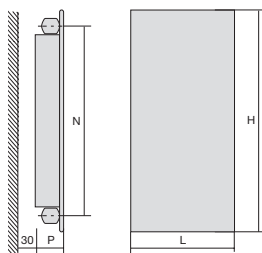

MODELO	VZA120	VZLA120
Altura H	1.213 mm	1.213 mm
Entre ejes N	1.133 mm	1.133 mm
Profundidad P	49 mm	62 mm
Exponente n	1,31	1,32

Recuerde pedir el Pack de Conexión

Elementos	Longitud L		Emisión EN 442 75/65/20 ΔT 50K W	Emisión Caldera condens. ΔT 40K W	Emisión Bomba de calor ΔT 32,5K W	Blanco RAL 9016 PVP €	Emisión EN 442 75/65/20 ΔT 50K W	Emisión Caldera condens. ΔT 40K W	Emisión Bomba de calor ΔT 32,5K W	Blanco RAL 9016 PVP €
	Nominal mm	Real mm								
2	140	157	170	127	97	611,58	236	176	134	1.095,69
3	210	231	255	190	145	733,34	354	264	200	1.207,90
4	280	305	340	254	193	855,10	472	352	267	1.320,11
5	350	379	425	317	242	976,86	590	439	334	1.432,32
6	420	453	510	381	290	1.098,62	708	527	401	1.544,53
7	490	527	595	444	338	1.220,38	826	615	468	1.656,74
8	560	601	680	508	387	1.342,14	944	703	535	1.768,95
9	630	675	765	571	435	1.463,90	1.062	791	601	1.881,16
10	700	749	850	635	483	1.585,66	1.180	879	668	1.993,37
11	770	823	935	698	532	1.707,42	1.298	967	735	2.105,58
12	840	897	1.020	761	580	1.829,18	1.416	1.055	802	2.217,79
13	910	971	1.105	825	628	1.950,94	1.534	1.143	869	2.330,00
14	980	1.045	1.190	888	677	2.072,70	1.652	1.231	936	2.442,21
15	1.050	1.119	1.275	952	725	2.194,46	1.770	1.318	1.002	2.554,42
16	1.120	1.193	1.360	1.015	773	2.316,22	1.888	1.406	1.069	2.666,63

Precios para color blanco estándar RAL 9016.

Precios para carta de colores Zehnder +25%. Otros colores, consultar.



# Zehnder Arteplano

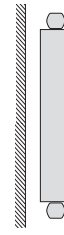
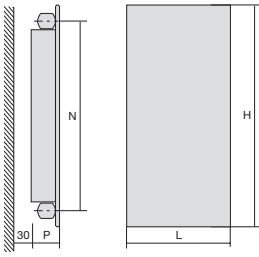

MODELO	VZA140	VZLA140
Altura H	1.413 mm	1.413 mm
Entre ejes N	1.333 mm	1.333 mm
Profundidad P	49 mm	62 mm
Exponente n	1,31	1,31

Recuerde pedir el Pack de Conexión

Elementos	Longitud L		Emisión EN 442 75/65/20 ΔT 50K W	Emisión Caldera condens. ΔT 40K W	Emisión Bomba de calor ΔT 32,5K W	Blanco RAL 9016 PVP €	Emisión EN 442 75/65/20 ΔT 50K W	Emisión Caldera condens. ΔT 40K W	Emisión Bomba de calor ΔT 32,5K W	Blanco RAL 9016 PVP €
	Nominal mm	Real mm								
2	140	157	196	146	111	644,37	272	203	155	1.191,17
3	210	231	294	219	167	778,56	408	305	232	1.317,89
4	280	305	392	293	223	912,75	544	406	309	1.444,61
5	350	379	490	366	279	1.046,94	680	508	387	1.571,33
6	420	453	588	439	334	1.181,13	816	609	464	1.698,05
7	490	527	686	512	390	1.315,32	952	711	541	1.824,77
8	560	601	784	585	446	1.449,51	1.088	812	619	1.951,49
9	630	675	882	658	502	1.583,70	1.224	914	696	2.078,21
10	700	749	980	732	557	1.717,89	1.360	1.015	773	2.204,93
11	770	823	1.078	805	613	1.852,08	1.496	1.117	851	2.331,65
12	840	897	1.176	878	669	1.986,27	1.632	1.218	928	2.458,37
13	910	971	1.274	951	725	2.120,46	1.768	1.320	1.006	2.585,09
14	980	1.045	1.372	1.024	780	2.254,65	1.904	1.421	1.083	2.711,81
15	1.050	1.119	1.470	1.097	836	2.388,84	2.040	1.523	1.160	2.838,53
16	1.120	1.193	1.568	1.171	892	2.523,03	2.176	1.624	1.238	2.965,25

Precios para color blanco estándar RAL 9016.

Precios para carta de colores Zehnder +25%. Otros colores, consultar.

# Zehnder Arteplano

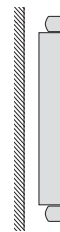
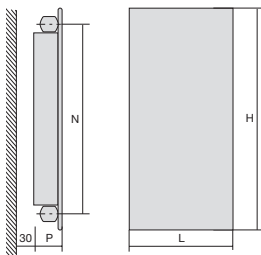

MODELO	VZA160	VZLA160
Altura H	1.613 mm	1.613 mm
Entre ejes N	1.533 mm	1.533 mm
Profundidad P	49 mm	62 mm
Exponente n	1,31	1,31

Recuerde pedir el Pack de Conexión

Elementos	Longitud L		Emisión EN 442 75/65/20 ΔT 50K W	Emisión Caldera condens. ΔT 40K W	Emisión Bomba de calor ΔT 32,5K W	Blanco RAL 9016 PVP €	Emisión EN 442 75/65/20 ΔT 50K W	Emisión Caldera condens. ΔT 40K W	Emisión Bomba de calor ΔT 32,5K W	Blanco RAL 9016 PVP €
	Nominal mm	Real mm								
2	140	157	224	167	127	677,19	310	231	176	1.261,04
3	210	231	336	251	191	823,83	465	347	264	1.400,14
4	280	305	448	334	255	970,47	620	463	353	1.539,24
5	350	379	560	418	318	1.117,11	775	579	441	1.678,34
6	420	453	672	502	382	1.263,75	930	694	529	1.817,44
7	490	527	784	585	446	1.410,39	1.085	810	617	1.956,54
8	560	601	896	669	510	1.557,03	1.240	926	705	2.095,64
9	630	675	1.008	753	573	1.703,67	1.395	1.041	793	2.234,74
10	700	749	1.120	836	637	1.850,31	1.550	1.157	882	2.373,84
11	770	823	1.232	920	701	1.996,95	1.705	1.273	970	2.512,94
12	840	897	1.344	1.003	764	2.143,59	1.860	1.389	1.058	2.652,04
13	910	971	1.456	1.087	828	2.290,23	2.015	1.504	1.146	2.791,14
14	980	1.045	1.568	1.171	892	2.436,87	2.170	1.620	1.234	2.930,24
15	1.050	1.119	1.680	1.254	955	2.583,51	2.325	1.736	1.322	3.069,34
16	1.120	1.193	1.792	1.338	1.019	2.730,15	2.480	1.851	1.410	3.208,44

Precios para color blanco estándar RAL 9016.

Precios para carta de colores Zehnder +25%. Otros colores, consultar.



# Zehnder Arteplano

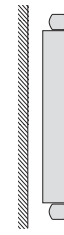
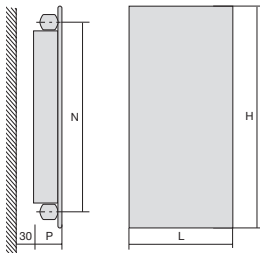

MODELO	VZA180	VZLA180
Altura H	1.813 mm	1.813 mm
Entre ejes N	1.733 mm	1.733 mm
Profundidad P	49 mm	62 mm
Exponente n	1,30	1,31

Recuerde pedir el Pack de Conexión

Elementos	Longitud L		Emisión EN 442 75/65/20 ΔT 50K W	Emisión Caldera condens. ΔT 40K W	Emisión Bomba de calor ΔT 32,5K W	Blanco RAL 9016 PVP €	Emisión EN 442 75/65/20 ΔT 50K W	Emisión Caldera condens. ΔT 40K W	Emisión Bomba de calor ΔT 32,5K W	Blanco RAL 9016 PVP €
	Nominal mm	Real mm								
2	140	157	260	195	149	709,97	348	260	198	1.266,21
3	210	231	390	292	223	869,04	522	390	297	1.404,83
4	280	305	520	389	297	1.028,11	696	520	396	1.543,45
5	350	379	650	486	371	1.187,18	870	649	495	1.682,07
6	420	453	780	584	446	1.346,25	1.044	779	594	1.820,69
7	490	527	910	681	520	1.505,32	1.218	909	693	1.959,31
8	560	601	1.040	778	594	1.664,39	1.392	1.039	792	2.097,93
9	630	675	1.170	875	668	1.823,46	1.566	1.169	891	2.236,55
10	700	749	1.300	973	743	1.982,53	1.740	1.299	990	2.375,17
11	770	823	1.430	1.070	817	2.141,60	1.914	1.429	1.089	2.513,79
12	840	897	1.560	1.167	891	2.300,67	2.088	1.559	1.188	2.652,41
13	910	971	1.690	1.264	965	2.459,74	2.262	1.689	1.286	2.791,03
14	980	1.045	1.820	1.362	1.040	2.618,81	2.436	1.819	1.385	2.929,65
15	1.050	1.119	1.950	1.459	1.114	2.777,88	2.610	1.948	1.484	3.068,27
16	1.120	1.193	2.080	1.556	1.188	2.936,95	2.784	2.078	1.583	3.206,89

Precios para color blanco estándar RAL 9016.

Precios para carta de colores Zehnder +25%. Otros colores, consultar.

# Zehnder Arteplano

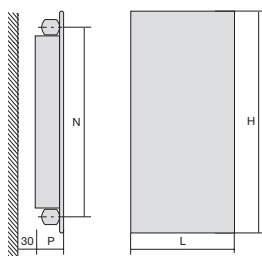

MODELO	VZA190	VZLA190
Altura H	1.913 mm	1.913 mm
Entre ejes N	1.833 mm	1.833 mm
Profundidad P	49 mm	62 mm
Exponente n	1,30	1,31

Recuerde pedir el Pack de Conexión

Elementos	Longitud L		Emisión EN 442 75/65/20 ΔT 50K W	Emisión Caldera condens. ΔT 40K W	Emisión Bomba de calor ΔT 32,5K W	Blanco RAL 9016 PVP €	Emisión EN 442 75/65/20 ΔT 50K W	Emisión Caldera condens. ΔT 40K W	Emisión Bomba de calor ΔT 32,5K W	Blanco RAL 9016 PVP €
	Nominal mm	Real mm								
2	140	157	269	201	154	726,34	361	269	205	1.278,24
3	210	231	404	302	230	891,60	542	404	308	1.418,84
4	280	305	538	403	307	1.056,86	722	539	411	1.559,44
5	350	379	673	503	384	1.222,12	903	674	513	1.700,04
6	420	453	807	604	461	1.387,38	1.083	808	616	1.840,64
7	490	527	942	704	538	1.552,64	1.264	943	719	1.981,24
8	560	601	1.076	805	615	1.717,90	1.444	1.078	821	2.121,84
9	630	675	1.211	906	691	1.883,16	1.625	1.213	924	2.262,44
10	700	749	1.345	1.006	768	2.048,42	1.805	1.347	1.027	2.403,04
11	770	823	1.480	1.107	845	2.213,68	1.986	1.482	1.129	2.543,64
12	840	897	1.614	1.208	922	2.378,94	2.166	1.617	1.232	2.684,24
13	910	971	1.749	1.308	999	2.544,20	2.347	1.752	1.335	2.824,84
14	980	1.045	1.883	1.409	1.076	2.709,46	2.527	1.886	1.437	2.965,44
15	1.050	1.119	2.018	1.509	1.152	2.874,72	2.708	2.021	1.540	3.106,04
16	1.120	1.193	2.152	1.610	1.229	3.039,98	2.888	2.156	1.643	3.246,64

Precios para color blanco estándar RAL 9016.

Precios para carta de colores Zehnder +25%. Otros colores, consultar.



# Zehnder Arteplano

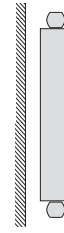
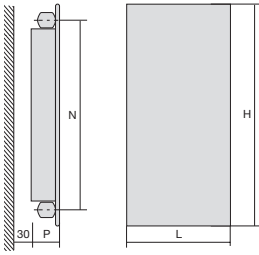

MODELO	VZA200	VZLA200
Altura H	2.013 mm	2.013 mm
Entre ejes N	1.933 mm	1.933 mm
Profundidad P	49 mm	62 mm
Exponente n	1,30	1,31

Recuerde pedir el Pack de Conexión

Elementos	Longitud L		Emisión EN 442 75/65/20 $\Delta T$ 50K W	Emisión Caldera condens. $\Delta T$ 40K W	Emisión Bomba de calor $\Delta T$ 32,5K W	Blanco RAL 9016 PVP €	Emisión EN 442 75/65/20 $\Delta T$ 50K W	Emisión Caldera condens. $\Delta T$ 40K W	Emisión Bomba de calor $\Delta T$ 32,5K W	Blanco RAL 9016 PVP €
	Nominal mm	Real mm								
2	140	157	290	217	166	742,76	374	279	213	1.308,90
3	210	231	435	325	248	914,26	561	419	319	1.453,55
4	280	305	580	434	331	1.085,76	748	558	425	1.598,20
5	350	379	725	542	414	1.257,26	935	698	532	1.742,85
6	420	453	870	651	497	1.428,76	1.122	838	638	1.887,50
7	490	527	1.015	759	580	1.600,26	1.309	977	744	2.032,15
8	560	601	1.160	868	663	1.771,76	1.496	1.117	851	2.176,80
9	630	675	1.305	976	745	1.943,26	1.683	1.256	957	2.321,45
10	700	749	1.450	1.085	828	2.114,76	1.870	1.396	1.064	2.466,10
11	770	823	1.595	1.193	911	2.286,26	2.057	1.536	1.170	2.610,75
12	840	897	1.740	1.302	994	2.457,76	2.244	1.675	1.276	2.755,40
13	910	971	1.885	1.410	1.077	2.629,26	2.431	1.815	1.383	2.900,05
14	980	1.045	2.030	1.519	1.160	2.800,76	2.618	1.954	1.489	3.044,70
15	1.050	1.119	2.175	1.627	1.242	2.972,26	2.805	2.094	1.595	3.189,35
16	1.120	1.193	2.320	1.736	1.325	3.143,76	2.992	2.234	1.702	3.334,00

Precios para color blanco estándar RAL 9016.

Precios para carta de colores Zehnder +25%. Otros colores, consultar.

# Zehnder Arteplano

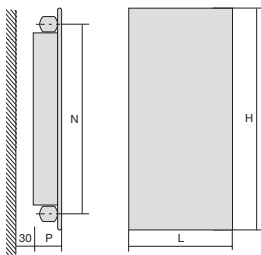

MODELO	VZA220	VZLA220
Altura H	2.213 mm	2.213 mm
Entre ejes N	2.133 mm	2.133 mm
Profundidad P	49 mm	62 mm
Exponente n	1,30	1,31

Recuerde pedir el Pack de Conexión

Elementos	Longitud L		Emisión EN 442 75/65/20 ΔT 50K W	Emisión Caldera condens. ΔT 40K W	Emisión Bomba de calor ΔT 32,5K W	Blanco RAL 9016 PVP €	Emisión EN 442 75/65/20 ΔT 50K W	Emisión Caldera condens. ΔT 40K W	Emisión Bomba de calor ΔT 32,5K W	Blanco RAL 9016 PVP €
	Nominal mm	Real mm								
2	140	157	318	238	182	775,58	396	296	225	1.370,22
3	210	231	477	357	272	959,52	594	443	338	1.522,98
4	280	305	636	476	363	1.143,46	792	591	450	1.675,74
5	350	379	795	595	454	1.327,40	990	739	563	1.828,50
6	420	453	954	714	545	1.511,34	1.188	887	676	1.981,26
7	490	527	1.113	833	636	1.695,28	1.386	1.035	788	2.134,02
8	560	601	1.272	952	727	1.879,22	1.584	1.183	901	2.286,78
9	630	675	1.431	1.071	817	2.063,16	1.782	1.330	1.014	2.439,54
10	700	749	1.590	1.190	908	2.247,10	1.980	1.478	1.126	2.592,30
11	770	823	1.749	1.309	999	2.431,04	2.178	1.626	1.239	2.745,06
12	840	897	1.908	1.428	1.090	2.614,98	2.376	1.774	1.351	2.897,82
13	910	971	2.067	1.547	1.181	2.798,92	2.574	1.922	1.464	3.050,58
14	980	1.045	2.226	1.665	1.271	2.982,86	2.772	2.069	1.577	3.203,34
15	1.050	1.119	2.385	1.784	1.362	3.166,80	2.970	2.217	1.689	3.356,10
16	1.120	1.193	2.544	1.903	1.453	3.350,74	3.168	2.365	1.802	3.508,86

Precios para color blanco estándar RAL 9016.

Precios para carta de colores Zehnder +25%. Otros colores, consultar.





# Zehnder Arteplano

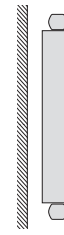
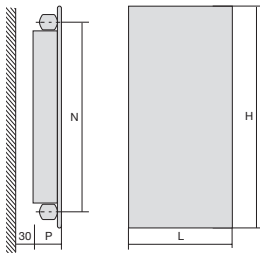

MODELO	VZA240	VZLA240
Altura H	2.413 mm	2.413 mm
Entre ejes N	2.333 mm	2.333 mm
Profundidad P	49 mm	62 mm
Exponente n	1,30	1,31

Recuerde pedir el Pack de Conexión

Elementos	Longitud L		Emisión EN 442 75/65/20 ΔT 50K W	Emisión Caldera condens. ΔT 40K W	Emisión Bomba de calor ΔT 32,5K W	Blanco RAL 9016 PVP €	Emisión EN 442 75/65/20 ΔT 50K W	Emisión Caldera condens. ΔT 40K W	Emisión Bomba de calor ΔT 32,5K W	Blanco RAL 9016 PVP €
	Nominal mm	Real mm								
2	140	157	334	250	191	808,33	420	314	239	1.463,62
3	210	231	501	375	286	1.004,68	630	470	358	1.624,51
4	280	305	668	500	382	1.201,03	840	627	478	1.785,40
5	350	379	835	625	477	1.397,38	1.050	784	597	1.946,29
6	420	453	1.002	750	572	1.593,73	1.260	941	717	2.107,18
7	490	527	1.169	875	668	1.790,08	1.470	1.097	836	2.268,07
8	560	601	1.336	1.000	763	1.986,43	1.680	1.254	955	2.428,96
9	630	675	1.503	1.125	859	2.182,78	1.890	1.411	1.075	2.589,85
10	700	749	1.670	1.249	954	2.379,13	2.100	1.568	1.194	2.750,74
11	770	823	1.837	1.374	1.049	2.575,48	2.310	1.724	1.314	2.911,63
12	840	897	2.004	1.499	1.145	2.771,83	2.520	1.881	1.433	3.072,52
13	910	971	2.171	1.624	1.240	2.968,18	2.730	2.038	1.553	3.233,41
14	980	1.045	2.338	1.749	1.335	3.164,53	2.940	2.195	1.672	3.394,30
15	1.050	1.119	2.505	1.874	1.431	3.360,88	3.150	2.352	1.792	3.555,19
16	1.120	1.193	2.672	1.999	1.526	3.557,23	3.360	2.508	1.911	3.716,08

Precios para color blanco estándar RAL 9016.

Precios para carta de colores Zehnder +25%. Otros colores, consultar.

# Zehnder Arteplano

## FIGURAS DE CONEXIÓN

**Conexiones Bitubo normales.** Sin suplemento de precio.

Misma mano



Cruzados

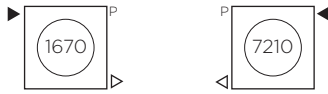

Lados opuestos

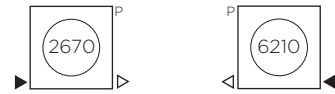

**Conexiones Bitubo especiales.** Con suplemento de precio **58,43 €.**

Desde abajo / hacia abajo



Desde arriba / hacia arriba



**Conexiones Mono-Bitubo especiales.** Con suplemento de precio **58,43 €.**

Racores juntos abajo\*  
Modelos horizontales

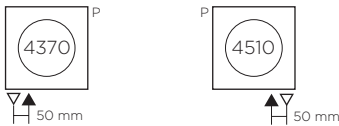

Racores juntos abajo\*\*  
Modelos verticales

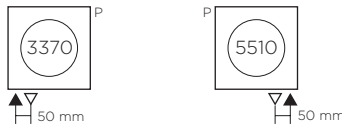

Desde abajo / hacia abajo

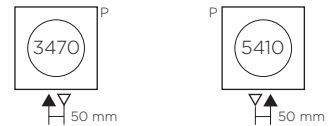

\*En los modelos horizontales la impulsión se hace por el racor interior del radiador.

\*\*En los modelos verticales la impulsión se hace por el racor exterior del radiador.

**Conexiones Monotubo.** Con suplemento de precio **58,43 €.**

Atención: respetar longitudes de las cañas.

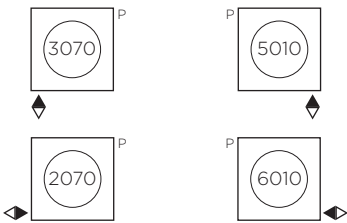

Longitud de la caña	Radiadores verticales	Radiadores horizontales
Figuras 3070 y 5010 entrada de agua por el interior de la caña	L = 47 mm	L = 150 mm
Figuras 2070 y 6010 entrada de agua por el exterior de la caña	L = 150 mm	L = 47 mm

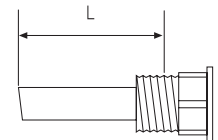

P = Purga V = Vaciado

## MEDIDAS DE RACORES

Otras posiciones de racores, por ejemplo desde arriba hacia arriba, hacia atrás o adelante, pueden suministrarse bajo pedido, con suplemento de precio a consultar.

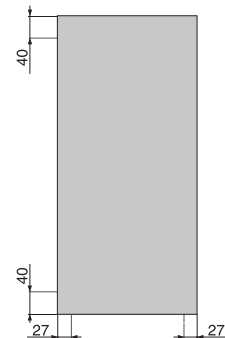
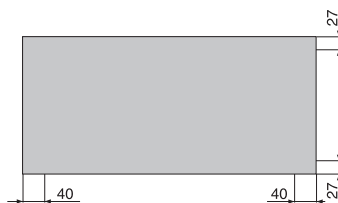

# Zehnder Arteplano

## SOPORTES ESTÁNDAR

### Kit de soportes

Soportes a la pared incluidos en el embalaje. En el color del radiador solo con el pedido inicial.

Cada radiador lleva el Kit con su cantidad y tipo necesario de soportes murales. (A la pared).

### Kit de soportes adicional

Al pedir un Kit de soportes adicional hay que indicar para qué radiador. Diferentes radiadores usan diferentes kits.

Blanco estándar (RAL 9016)

PVP **54,67 €**

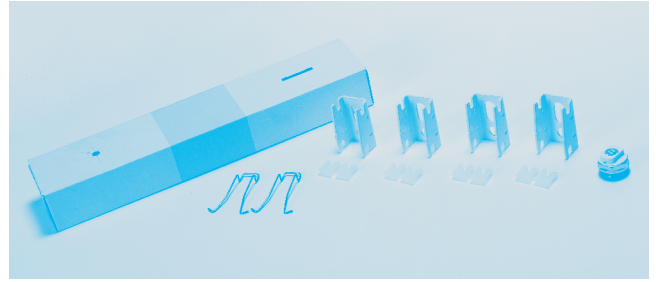

## SOPORTES SOLDADOS

Soldados en fábrica. Solo con el pedido del radiador.

Hasta modelos de 366 mm de altura sin pie, no es preciso soporte mural.

A partir de 440 mm de altura sin pie, se prevé soporte mural en la parte superior.

En el caso de pedirse soportes a medida, hay que definir las cotas A, B y C.



FC

Dimensiones de la base: 100 x 50 mm.

Tipo de soporte	Distancia al suelo/techo/pared		Referencia	PVP €
	C mínimo mm	C máximo mm		
<b>Soportes de pie soldados</b>				
Altura regulable	150	200	FC200	<b>101,99</b>
	120	150	FC150	
A medida	A medida		FRCUS	<b>154,43</b>
<b>Soporte lateral atornillado</b>				
Regulable	60	170	RDL/RDR	<b>110,14</b>

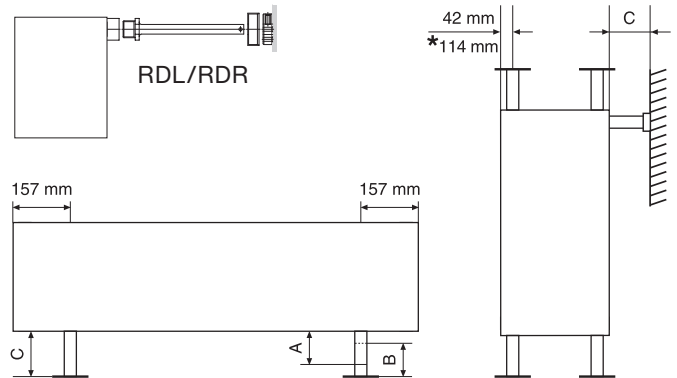

\*A partir de 5 elementos.

# Zehnder Charleston

Desde 1930: el gran clásico

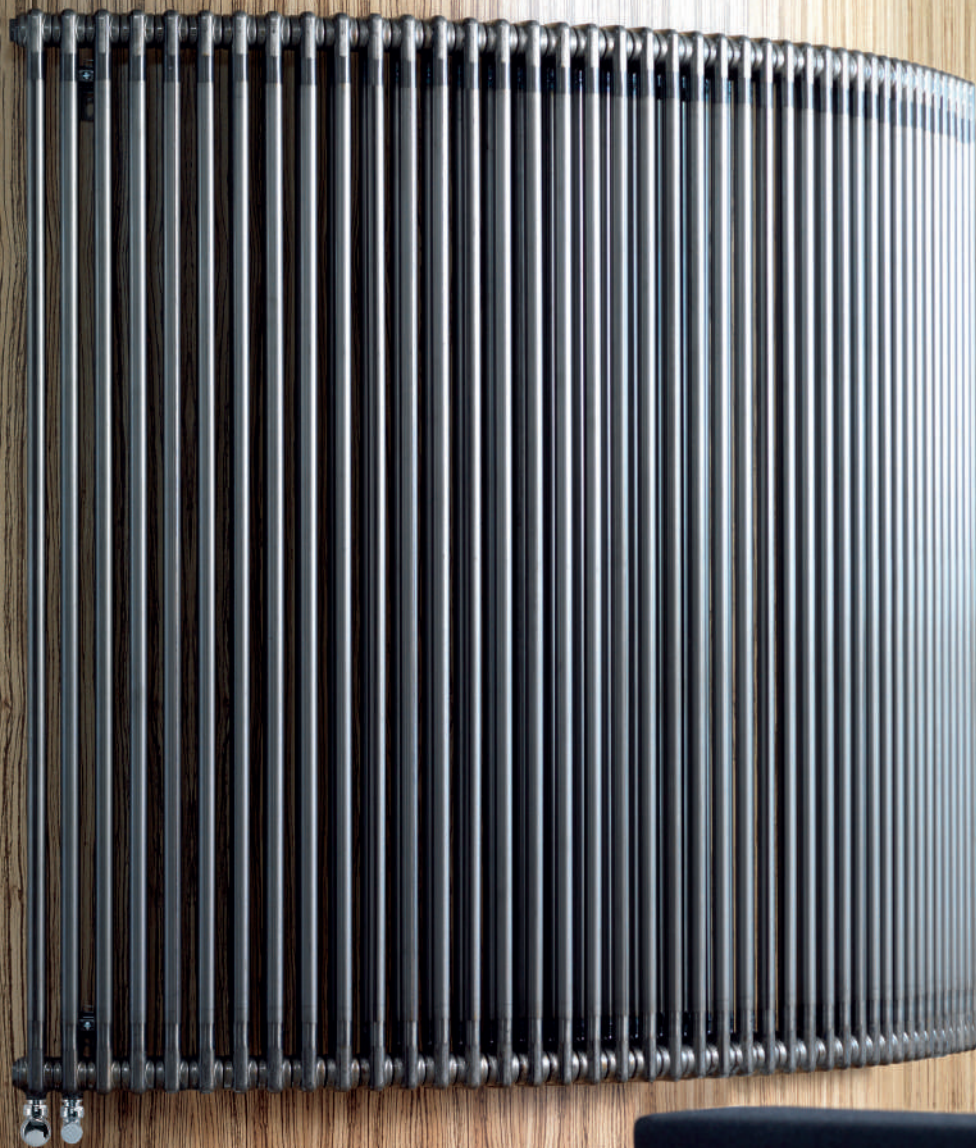

El gran clásico. Zehnder Charleston es el radiador original, patentado por Zehnder en 1930. Un diseño intemporal que conjuga forma, función y confort para adaptarse a todos los desafíos arquitectónicos. Y para integrarse en todo tipo de estancias. Sea cual sea su estilo. O su tamaño. Una solución flexible que brinda máximo bienestar y viste los espacios de una agradable calidez.



# Zehnder Charleston

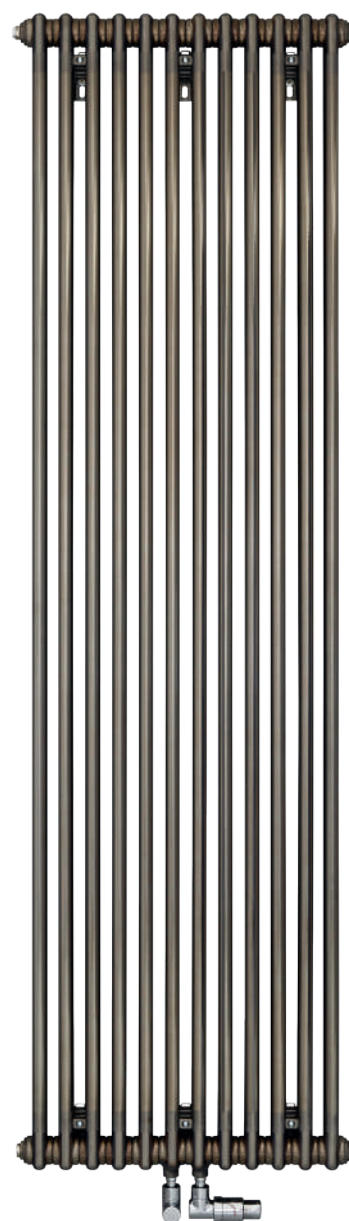

# Zehnder Charleston

## VERSIONES Y ACABADOS

Disponible en versiones de 2, 3 o 4 columnas (ver páginas 48 y 49). Modelos de 5 y 6 columnas disponibles hasta 1.200 mm. Para otras opciones, consultar.

Se suministra en color blanco (RAL 9016).

Disponible en los colores de la carta Zehnder (ver página 10).

Para otros colores o acabados, consultar.

Alturas Retrofit disponibles: 350, 500, 600, 620 y 650 mm.

### Ejecuciones especiales:

Radiadores en ángulo.

Radiadores curvos.

Longitudes o altura especiales.

Posición de racores especial y figuras de conexión distintas (ver página 90).

Alta presión.

Soportes de pie a consultar.

Todas las ejecuciones especiales deben ser consultadas para verificar disponibilidad y precio.

## SOPORTES ZEHNDER EASYFIX SMB

Soportes Zehnder EasyFix SMB incluidos en el embalaje. En el color del radiador solo con el pedido inicial.

Cada radiador lleva el kit de soportes a la pared necesario según sus dimensiones.

### Kit de soportes a la pared adicional blanco estándar (RAL 9016):

Juego de 2 soportes verticales SMB

PVP **27,87 €**

Juego de 3 soportes verticales SMB

PVP **41,80 €**

Juego de 4 soportes verticales SMB

PVP **55,72 €**

Para solicitar soportes de recambio es necesario indicar el modelo de radiador.

## PACK DE CONEXIÓN

Incluye todas las piezas necesarias para la conexión (ver página 257).

### Bitubo:

Para la conexión estándar.

Juego de Válvula + Detentor.

Tipo B.



Tipo B

### Monotubo:

Válvula Monotubo Horizontal. Tipo N.

Solo bajo pedido. Hay que indicarlo en el pedido inicial.



Tipo N

Tipo de válvula	Acabado	Regulación manual PVP €	Regulación termostática PVP €
Todos los tipos de válvulas	Todos los acabados	<b>202,59</b>	<b>268,14</b>

# Zehnder Charleston

## ESPECIFICACIONES TÉCNICAS

### Modelo 2 columnas

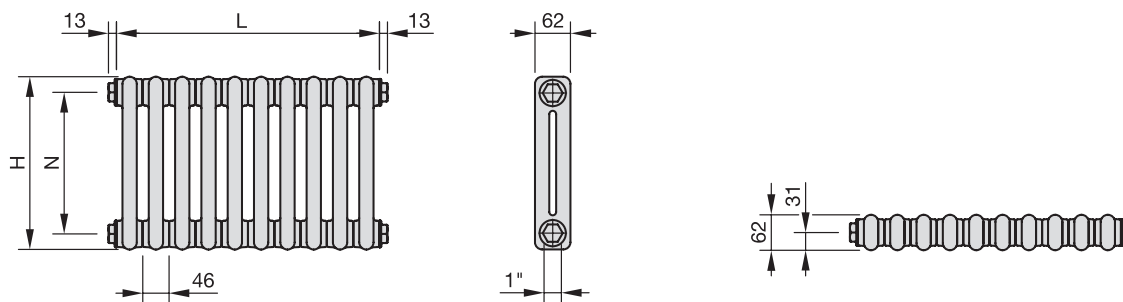

### Modelo 3 columnas

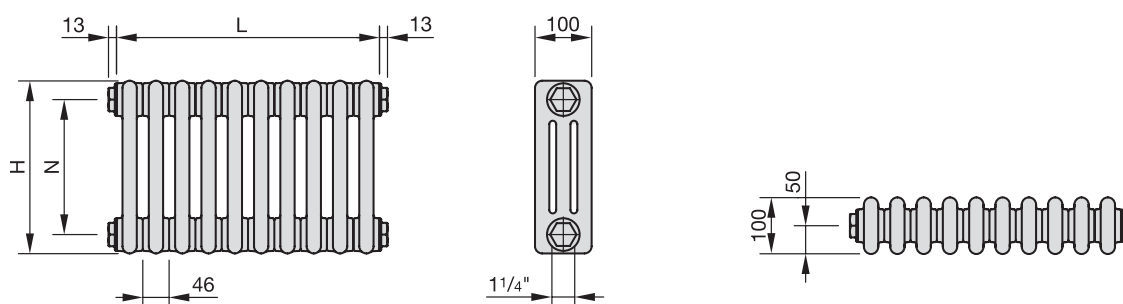

### Modelo 4 columnas

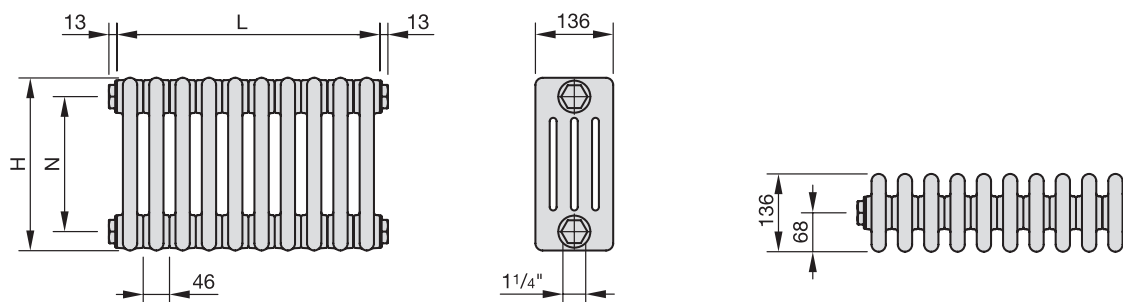

L = Longitud. H = Altura. N = Distancia entre ejes.



# Zehnder Charleston

## ESPECIFICACIONES TÉCNICAS

### Modelo 5 columnas - Hasta 1.200 mm

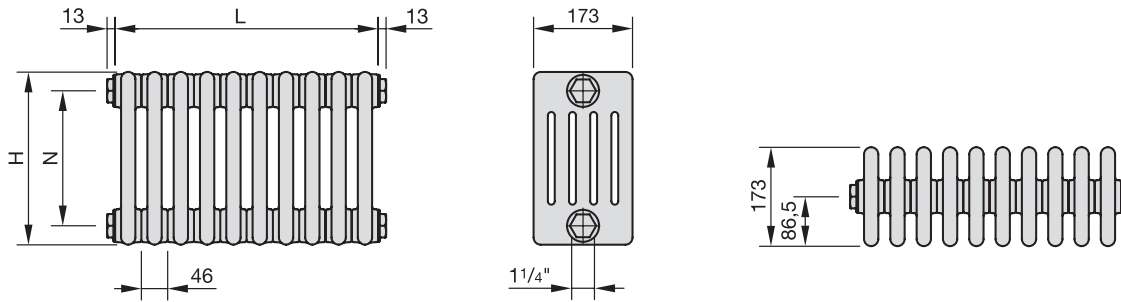

### Modelo 6 columnas - Hasta 1.200 mm

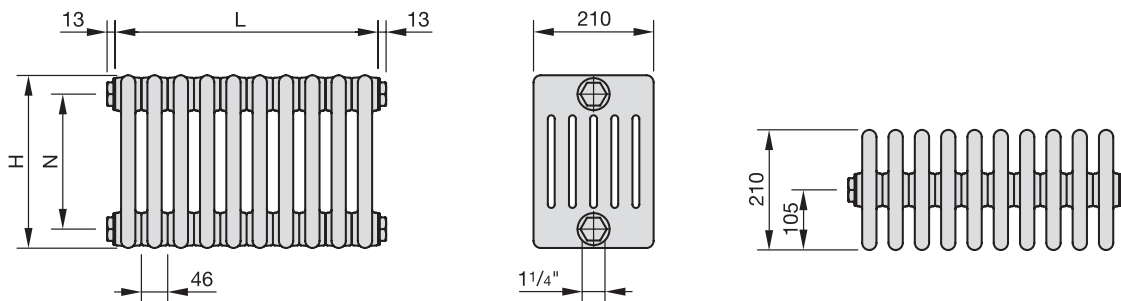

- Cabezales de acero de 1,5 mm de espesor.
- Tubos redondos de acero Ø 25 mm.
- 2, 3 y 4 Columnas: Presión máxima de servicio 12 bar. Presión de prueba en fabrica 15.6 bar.
- 5 y 6 Columnas: Presión máxima de servicio 10 bar. Presión de prueba en fabrica 13 bar.

L = Longitud. H = Altura. N = Distancia entre ejes.

# Zehnder Charleston

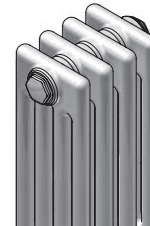
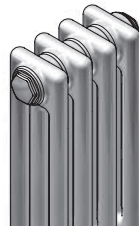
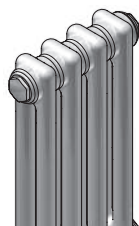
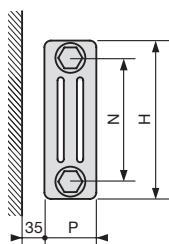

MODELO	2026	3026	4026
Altura H	260 mm	260 mm	260 mm
Entre ejes N	202 mm	194 mm	194 mm
Profundidad P	62 mm	100 mm	136 mm
Exponente n	1,25	1,25	1,25

Recuerde pedir el Pack de Conexión

Longitud L	Elem.	mm	Emisión	Emisión	Emisión	Blanco	Emisión	Emisión	Emisión	Blanco	Emisión	Emisión	Emisión	Blanco
			EN 442 75/65/20 ΔT 50K W	Caldera condens. ΔT 40K W	Bomba de calor ΔT 32,5K W	RAL 9016 PVP €	EN 442 75/65/20 ΔT 50K W	Caldera condens. ΔT 40K W	Bomba de calor ΔT 32,5K W	RAL 9016 PVP €	EN 442 75/65/20 ΔT 50K W	Caldera condens. ΔT 40K W	Bomba de calor ΔT 32,5K W	RAL 9016 PVP €
4	184	84	64	49	95,35	112	84	65	110,11	146	110	85	127,03	
5	230	106	80	62	112,22	140	106	81	130,67	183	138	107	151,82	
6	276	127	96	74	129,09	167	127	98	151,23	219	166	128	176,61	
7	322	148	112	86	145,96	195	148	114	171,79	256	193	149	201,40	
8	368	169	128	99	162,83	223	169	130	192,35	292	221	170	226,19	
9	414	190	144	111	179,70	251	190	147	212,91	329	249	192	250,98	
10	460	211	160	123	196,57	279	211	163	233,47	365	276	213	275,77	
11	506	232	176	135	213,44	307	232	179	254,03	402	304	234	300,56	
12	552	253	192	148	230,31	335	253	195	274,59	438	331	256	325,35	
13	598	274	208	160	247,18	363	274	212	295,15	475	359	277	350,14	
14	644	295	223	172	264,05	391	296	228	315,71	511	387	298	374,93	
15	690	317	239	185	280,92	419	317	244	336,27	548	414	320	399,72	
16	736	338	255	197	297,79	446	338	261	356,83	584	442	341	424,51	
17	782	359	271	209	314,66	474	359	277	377,39	621	469	362	449,30	
18	828	380	287	222	331,53	502	380	293	397,95	657	497	383	474,09	
19	874	401	303	234	348,40	530	401	309	418,51	694	525	405	498,88	
20	920	422	319	246	365,27	558	422	326	439,07	730	552	426	523,67	
21	966	443	335	259	382,14	586	443	342	459,63	767	580	447	548,46	
22	1.012	464	351	271	399,01	614	464	358	480,19	803	608	469	573,25	
23	1.058	485	367	283	429,81	642	486	375	514,68	840	635	490	611,97	
24	1.104	506	383	296	446,68	670	507	391	535,24	876	663	511	636,76	
25	1.150	528	399	308	463,55	698	528	407	555,80	913	690	533	661,55	
26	1.196	549	415	320	480,42	725	549	423	576,36	949	718	554	686,34	
27	1.242	570	431	332	497,29	753	570	440	596,92	986	746	575	711,13	
28	1.288	591	447	345	514,16	781	591	456	617,48	1.022	773	596	735,92	
29	1.334	612	463	357	531,03	809	612	472	638,04	1.059	801	618	760,71	
30	1.380	633	479	369	547,90	837	633	489	658,60	1.095	828	639	785,50	
31	1.426	654	495	382	564,77	865	654	505	679,16	1.132	856	660	810,29	
32	1.472	675	511	394	581,64	893	675	521	699,72	1.168	884	682	835,08	
33	1.518	696	527	406	598,51	921	697	537	720,28	1.205	911	703	859,87	
34	1.564	717	543	419	615,38	949	718	554	740,84	1.241	939	724	884,66	
35	1.610	739	559	431	632,25	977	739	570	761,40	1.278	967	746	909,45	
36	1.656	760	575	443	649,12	1.004	760	586	781,96	1.314	994	767	934,24	
37	1.702	781	591	456	665,99	1.032	781	602	802,52	1.351	1.022	788	959,03	
38	1.748	802	607	468	682,86	1.060	802	619	823,08	1.387	1.049	810	983,82	
39	1.794	823	623	480	699,73	1.088	823	635	843,64	1.424	1.077	831	1.008,61	
40	1.840	844	639	493	730,52	1.116	844	651	878,12	1.460	1.105	852	1.047,32	

Precios para color blanco estándar RAL 9016.

Precios para carta de colores Zehnder +25%. Otros colores, consultar.



# Zehnder Charleston

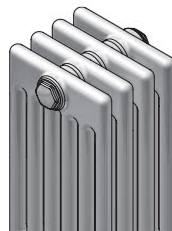
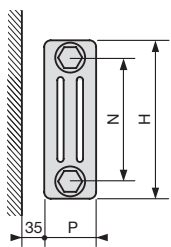

MODELO	5026	6026
Altura H	260 mm	260 mm
Entre ejes N	194 mm	194 mm
Profundidad P	173 mm	210 mm
Exponente n	1,25	1,27

Recuerde pedir el Pack de Conexión

Longitud L	Emisión EN 442 75/65/20 ΔT 50K W	Emisión Caldera condens. ΔT 40K W	Emisión Bomba de calor ΔT 32,5K W	Blanco RAL 9016 PVP €	Emisión EN 442 75/65/20 ΔT 50K W	Emisión Caldera condens. ΔT 40K W	Emisión Bomba de calor ΔT 32,5K W	Blanco RAL 9016 PVP €	
4	184	180	136	105	141,79	216	163	125	162,83
5	230	226	171	132	170,27	270	203	156	196,57
6	276	271	205	158	198,75	324	244	187	230,31
7	322	316	239	184	227,23	378	285	219	264,05
8	368	361	273	211	255,71	432	325	250	297,79
9	414	406	307	237	284,19	486	366	281	331,53
10	460	451	341	263	312,67	540	407	312	365,27
11	506	496	375	290	341,15	594	447	344	399,01
12	552	541	409	316	369,63	648	488	375	432,75
13	598	586	444	342	398,11	702	529	406	466,49
14	644	631	478	369	426,59	756	569	437	500,23
15	690	677	512	395	455,07	810	610	469	533,97
16	736	722	546	421	483,55	864	651	500	567,71
17	782	767	580	447	512,03	918	691	531	601,45
18	828	812	614	474	540,51	972	732	562	635,19
19	874	857	648	500	568,99	1.026	773	594	668,93
20	920	902	682	526	597,47	1.080	813	625	702,67
21	966	947	717	553	625,95	1.134	854	656	736,41
22	1.012	992	751	579	654,43	1.188	895	687	770,15
23	1.058	1.037	785	605	696,84	1.242	936	719	817,82
24	1.104	1.082	819	632	725,32	1.296	976	750	851,56
25	1.150	1.128	853	658	753,80	1.350	1.017	781	885,30
26	1.196	1.173	887	684	782,28	1.404	1.058	812	919,04
27	1.242	1.218	921	711	810,76	1.458	1.098	844	952,78
28	1.288	1.263	955	737	839,24	1.512	1.139	875	986,52
29	1.334	1.308	990	763	867,72	1.566	1.180	906	1.020,26
30	1.380	1.353	1.024	790	896,20	1.620	1.220	937	1.054,00
31	1.426	1.398	1.058	816	924,68	1.674	1.261	969	1.087,74
32	1.472	1.443	1.092	842	953,16	1.728	1.302	1.000	1.121,48
33	1.518	1.488	1.126	869	981,64	1.782	1.342	1.031	1.155,22
34	1.564	1.533	1.160	895	1.010,12	1.836	1.383	1.062	1.188,96
35	1.610	1.579	1.194	921	1.038,60	1.890	1.424	1.094	1.222,70
36	1.656	1.624	1.228	948	1.067,08	1.944	1.464	1.125	1.256,44
37	1.702	1.669	1.263	974	1.095,56	1.998	1.505	1.156	1.290,18
38	1.748	1.714	1.297	1.000	1.124,04	2.052	1.546	1.187	1.323,92
39	1.794	1.759	1.331	1.027	1.152,52	2.106	1.586	1.219	1.357,66
40	1.840	1.804	1.365	1.053	1.194,92	2.160	1.627	1.250	1.405,32

Precios para color blanco estándar RAL 9016.

Precios para carta de colores Zehnder +25%. Otros colores, consultar.



# Zehnder Charleston

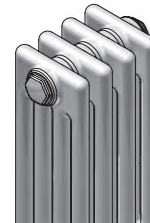
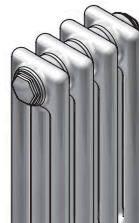
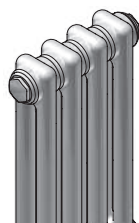
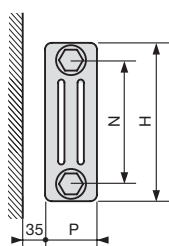

MODELO	2030	3030	4030
Altura H	300 mm	300 mm	300 mm
Entre ejes N	234 mm	234 mm	234 mm
Profundidad P	62 mm	100 mm	136 mm
Exponente n	1,24	1,25	1,25

Recuerde pedir el Pack de Conexión

Longitud L	Elem.	mm	Emisión	Emisión	Emisión	Blanco	Emisión	Emisión	Emisión	Blanco	Emisión	Emisión	Emisión	Blanco
			EN 442 75/65/20 ΔT 50K W	Caldera condens. ΔT 40K W	Bomba de calor ΔT 32,5K W	RAL 9016 PVP €	EN 442 75/65/20 ΔT 50K W	Caldera condens. ΔT 40K W	Bomba de calor ΔT 32,5K W	RAL 9016 PVP €	EN 442 75/65/20 ΔT 50K W	Caldera condens. ΔT 40K W	Bomba de calor ΔT 32,5K W	RAL 9016 PVP €
4	184	94	72	55	95,35	128	97	75	110,11	168	127	98	127,03	
5	230	118	89	69	112,22	160	121	93	130,67	210	159	122	151,82	
6	276	142	107	83	129,09	192	145	112	151,23	251	190	147	176,61	
7	322	165	125	97	145,96	224	169	131	171,79	293	222	171	201,40	
8	368	189	143	111	162,83	256	194	149	192,35	335	254	196	226,19	
9	414	212	161	124	179,70	288	218	168	212,91	377	285	220	250,98	
10	460	236	179	138	196,57	320	242	187	233,47	419	317	245	275,77	
11	506	260	197	152	213,44	352	266	205	254,03	461	349	269	300,56	
12	552	283	215	166	230,31	384	291	224	274,59	503	380	293	325,35	
13	598	307	233	180	247,18	416	315	243	295,15	545	412	318	350,14	
14	644	330	251	194	264,05	448	339	261	315,71	587	444	342	374,93	
15	690	354	268	207	280,92	480	363	280	336,27	629	476	367	399,72	
16	736	378	286	221	297,79	512	387	299	356,83	670	507	391	424,51	
17	782	401	304	235	314,66	544	412	317	377,39	712	539	416	449,30	
18	828	425	322	249	331,53	576	436	336	397,95	754	571	440	474,09	
19	874	448	340	263	348,40	608	460	355	418,51	796	602	465	498,88	
20	920	472	358	277	365,27	640	484	374	439,07	838	634	489	523,67	
21	966	496	376	290	382,14	672	508	392	459,63	880	666	514	548,46	
22	1.012	519	394	304	399,01	704	533	411	480,19	922	697	538	573,25	
23	1.058	543	412	318	429,81	736	557	430	514,68	964	729	562	611,97	
24	1.104	566	429	332	446,68	768	581	448	535,24	1.006	761	587	636,76	
25	1.150	590	447	346	463,55	800	605	467	555,80	1.048	793	611	661,55	
26	1.196	614	465	360	480,42	832	629	486	576,36	1.089	824	636	686,34	
27	1.242	637	483	373	497,29	864	654	504	596,92	1.131	856	660	711,13	
28	1.288	661	501	387	514,16	896	678	523	617,48	1.173	888	685	735,92	
29	1.334	684	519	401	531,03	928	702	542	638,04	1.215	919	709	760,71	
30	1.380	708	537	415	547,90	960	726	560	658,60	1.257	951	734	785,50	
31	1.426	732	555	429	564,77	992	751	579	679,16	1.299	983	758	810,29	
32	1.472	755	573	443	581,64	1.024	775	598	699,72	1.341	1.014	783	835,08	
33	1.518	779	591	456	598,51	1.056	799	616	720,28	1.383	1.046	807	859,87	
34	1.564	802	608	470	615,38	1.088	823	635	740,84	1.425	1.078	831	884,66	
35	1.610	826	626	484	632,25	1.120	847	654	761,40	1.467	1.110	856	909,45	
36	1.656	850	644	498	649,12	1.152	872	672	781,96	1.508	1.141	880	934,24	
37	1.702	873	662	512	665,99	1.184	896	691	802,52	1.550	1.173	905	959,03	
38	1.748	897	680	526	682,86	1.216	920	710	823,08	1.592	1.205	929	983,82	
39	1.794	920	698	539	699,73	1.248	944	728	843,64	1.634	1.236	954	1.008,61	
40	1.840	944	716	553	730,52	1.280	968	747	878,12	1.676	1.268	978	991,60	

Precios para color blanco estándar RAL 9016.  
Precios para carta de colores Zehnder +25%. Otros colores, consultar.



# Zehnder Charleston

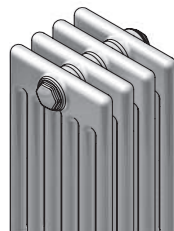
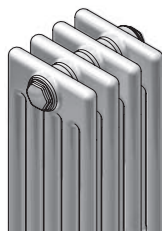
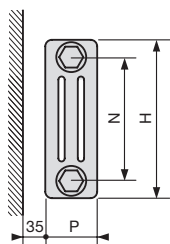

MODELO	5030	6030
Altura H	300 mm	300 mm
Entre ejes N	234 mm	234 mm
Profundidad P	173 mm	210 mm
Exponente n	1,25	1,26

Recuerde pedir el Pack de Conexión

Longitud L	Emisión EN 442 75/65/20 ΔT 50K W	Emisión Caldera condens. ΔT 40K W	Emisión Bomba de calor ΔT 32,5K W	Blanco RAL 9016 PVP €	Emisión EN 442 75/65/20 ΔT 50K W	Emisión Caldera condens. ΔT 40K W	Emisión Bomba de calor ΔT 32,5K W	Blanco RAL 9016 PVP €	
4	184	207	156	121	141,79	245	185	142	162,83
5	230	259	196	151	170,27	307	231	178	196,57
6	276	310	235	181	198,75	368	278	214	230,31
7	322	362	274	211	227,23	429	324	249	264,05
8	368	414	313	241	255,71	490	370	285	297,79
9	414	465	352	272	284,19	552	416	321	331,53
10	460	517	391	302	312,67	613	463	356	365,27
11	506	569	430	332	341,15	674	509	392	399,01
12	552	620	469	362	369,63	736	555	427	432,75
13	598	672	509	392	398,11	797	602	463	466,49
14	644	724	548	422	426,59	858	648	499	500,23
15	690	776	587	453	455,07	920	694	534	533,97
16	736	827	626	483	483,55	981	740	570	567,71
17	782	879	665	513	512,03	1.042	787	606	601,45
18	828	931	704	543	540,51	1.103	833	641	635,19
19	874	982	743	573	568,99	1.165	879	677	668,93
20	920	1.034	782	603	597,47	1.226	926	712	702,67
21	966	1.086	821	634	625,95	1.287	972	748	736,41
22	1.012	1.137	861	664	654,43	1.349	1.018	784	770,15
23	1.058	1.189	900	694	696,84	1.410	1.064	819	817,82
24	1.104	1.241	939	724	725,32	1.471	1.111	855	851,56
25	1.150	1.293	978	754	753,80	1.533	1.157	891	885,30
26	1.196	1.344	1.017	785	782,28	1.594	1.203	926	919,04
27	1.242	1.396	1.056	815	810,76	1.655	1.249	962	952,78
28	1.288	1.448	1.095	845	839,24	1.716	1.296	997	986,52
29	1.334	1.499	1.134	875	867,72	1.778	1.342	1.033	1.020,26
30	1.380	1.551	1.173	905	896,20	1.839	1.388	1.069	1.054,00
31	1.426	1.603	1.213	935	924,68	1.900	1.435	1.104	1.087,74
32	1.472	1.654	1.252	966	953,16	1.962	1.481	1.140	1.121,48
33	1.518	1.706	1.291	996	981,64	2.023	1.527	1.176	1.155,22
34	1.564	1.758	1.330	1.026	1.010,12	2.084	1.573	1.211	1.188,96
35	1.610	1.810	1.369	1.056	1.038,60	2.146	1.620	1.247	1.222,70
36	1.656	1.861	1.408	1.086	1.067,08	2.207	1.666	1.282	1.256,44
37	1.702	1.913	1.447	1.116	1.095,56	2.268	1.712	1.318	1.290,18
38	1.748	1.965	1.486	1.147	1.124,04	2.329	1.758	1.354	1.323,92
39	1.794	2.016	1.526	1.177	1.152,52	2.391	1.805	1.389	1.357,66
40	1.840	2.068	1.565	1.207	1.194,92	2.452	1.851	1.425	1.405,32

Precios para color blanco estándar RAL 9016.

Precios para carta de colores Zehnder +25%. Otros colores, consultar.



# Zehnder Charleston

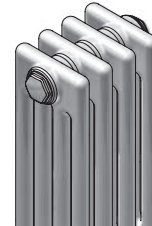
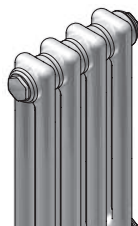
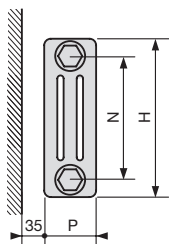

MODELO	2035	3035	4035
Altura H	350 mm	350 mm	350 mm
Entre ejes N	284 mm	284 mm	284 mm
Profundidad P	62 mm	100 mm	136 mm
Exponente n	1,24	1,25	1,25

Recuerde pedir el Pack de Conexión

Longitud L	Elem.	mm	Modelo 2035				Modelo 3035				Modelo 4035			
			Emisión EN 442 75/65/20 ΔT 50K W	Emisión Caldera condens. ΔT 40K W	Emisión Bomba de calor ΔT 32,5K W	Blanco RAL 9016 PVP €	Emisión EN 442 75/65/20 ΔT 50K W	Emisión Caldera condens. ΔT 40K W	Emisión Bomba de calor ΔT 32,5K W	Blanco RAL 9016 PVP €	Emisión EN 442 75/65/20 ΔT 50K W	Emisión Caldera condens. ΔT 40K W	Emisión Bomba de calor ΔT 32,5K W	Blanco RAL 9016 PVP €
4	184	110	83	64	97,51	148	112	86	110,11	194	147	113	127,03	
5	230	138	104	81	114,92	185	140	108	130,67	243	183	142	151,82	
6	276	165	125	97	132,33	222	168	130	151,23	291	220	170	176,61	
7	322	193	146	113	149,74	259	196	151	171,79	340	257	198	201,40	
8	368	220	167	129	167,15	296	224	173	192,35	388	294	226	226,19	
9	414	248	188	145	184,56	333	252	194	212,91	437	330	255	250,98	
10	460	275	209	161	201,97	370	280	216	233,47	485	367	283	275,77	
11	506	303	229	177	219,38	407	308	238	254,03	534	404	311	300,56	
12	552	330	250	193	236,79	444	336	259	274,59	582	440	340	325,35	
13	598	358	271	210	254,20	481	364	281	295,15	631	477	368	350,14	
14	644	385	292	226	271,61	518	392	302	315,71	679	514	396	374,93	
15	690	413	313	242	289,02	555	420	324	336,27	728	550	425	399,72	
16	736	440	334	258	306,43	592	448	346	356,83	776	587	453	424,51	
17	782	468	354	274	323,84	629	476	367	377,39	825	624	481	449,30	
18	828	495	375	290	341,25	666	504	389	397,95	873	661	510	474,09	
19	874	523	396	306	358,66	703	532	410	418,51	922	697	538	498,88	
20	920	550	417	322	376,07	740	560	432	439,07	970	734	566	523,67	
21	966	578	438	339	393,48	777	588	453	459,63	1.019	771	594	548,46	
22	1.012	605	459	355	410,89	814	616	475	480,19	1.067	807	623	573,25	
23	1.058	633	480	371	428,30	851	644	497	500,74	1.116	844	651	598,04	
24	1.104	660	500	387	445,71	888	672	518	521,29	1.164	881	679	622,83	
25	1.150	688	521	403	463,12	925	700	540	541,84	1.213	917	708	647,62	
26	1.196	715	542	419	480,53	962	728	561	562,39	1.261	954	736	672,41	
27	1.242	743	563	435	497,94	999	756	583	582,94	1.310	991	764	697,20	
28	1.288	770	584	451	515,35	1.036	784	605	603,49	1.358	1.027	793	722,00	
29	1.334	798	605	467	532,76	1.073	812	626	624,04	1.407	1.064	821	746,79	
30	1.380	825	626	484	550,17	1.110	840	648	644,59	1.455	1.101	849	771,58	
31	1.426	853	646	500	567,58	1.147	868	669	666,14	1.504	1.138	877	796,37	
32	1.472	880	667	516	585,00	1.184	896	691	683,69	1.552	1.174	906	821,16	
33	1.518	908	688	532	602,41	1.221	924	713	701,24	1.601	1.211	934	845,95	
34	1.564	935	709	548	619,82	1.258	952	734	718,79	1.649	1.248	962	870,74	
35	1.610	963	730	564	637,23	1.295	980	756	736,34	1.698	1.284	991	895,53	
36	1.656	990	751	580	654,64	1.332	1.008	777	753,89	1.746	1.321	1.019	920,32	
37	1.702	1.018	772	596	672,05	1.369	1.036	799	771,44	1.795	1.358	1.047	945,11	
38	1.748	1.045	792	613	689,46	1.406	1.064	821	788,99	1.843	1.394	1.076	969,90	
39	1.794	1.073	813	629	706,87	1.443	1.092	842	806,54	1.892	1.431	1.104	994,69	
40	1.840	1.100	834	645	724,28	1.480	1.120	864	824,09	1.940	1.468	1.132	1.019,48	

Precios para color blanco estándar RAL 9016.

Precios para carta de colores Zehnder +25%. Otros colores, consultar.



# Zehnder Charleston

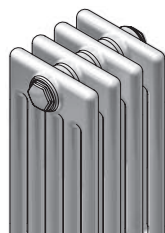
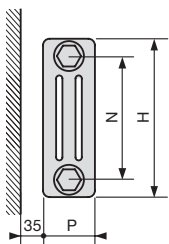

MODELO	5035	6035
Altura H	350 mm	350 mm
Entre ejes N	284 mm	284 mm
Profundidad P	173 mm	210 mm
Exponente n	1,26	1,26

Recuerde pedir el Pack de Conexión

Longitud L	Emisión EN 442 75/65/20 ΔT 50K W	Emisión Caldera condens. ΔT 40K W	Emisión Bomba de calor ΔT 32,5K W	Blanco RAL 9016 PVP €	Emisión EN 442 75/65/20 ΔT 50K W	Emisión Caldera condens. ΔT 40K W	Emisión Bomba de calor ΔT 32,5K W	Blanco RAL 9016 PVP €	
4	184	240	181	139	146,03	284	214	165	162,83
5	230	300	226	174	175,57	355	268	206	196,57
6	276	359	271	209	205,11	426	322	248	230,31
7	322	419	317	244	234,65	497	375	289	264,05
8	368	479	362	278	264,19	568	429	330	297,79
9	414	539	407	313	293,73	639	482	371	331,53
10	460	599	452	348	323,27	710	536	413	365,27
11	506	659	497	383	352,81	781	590	454	399,01
12	552	719	543	418	382,35	852	643	495	432,75
13	598	779	588	453	411,89	923	697	536	466,49
14	644	839	633	487	441,43	994	750	578	500,23
15	690	899	678	522	470,97	1.065	804	619	533,97
16	736	958	724	557	500,51	1.136	858	660	567,71
17	782	1.018	769	592	530,05	1.207	911	701	601,45
18	828	1.078	814	627	559,59	1.278	965	743	635,19
19	874	1.138	859	661	589,13	1.349	1.018	784	668,93
20	920	1.198	904	696	618,67	1.420	1.072	825	702,67
21	966	1.258	950	731	648,21	1.491	1.126	866	736,41
22	1.012	1.318	995	766	677,75	1.562	1.179	908	770,15
23	1.058	1.378	1.040	801	721,22	1.633	1.233	949	817,82
24	1.104	1.438	1.085	835	750,76	1.704	1.286	990	851,56
25	1.150	1.498	1.130	870	780,30	1.775	1.340	1.031	885,30
26	1.196	1.557	1.176	905	809,84	1.846	1.394	1.073	919,04
27	1.242	1.617	1.221	940	839,38	1.917	1.447	1.114	952,78
28	1.288	1.677	1.266	975	868,92	1.988	1.501	1.155	986,52
29	1.334	1.737	1.311	1.009	898,46	2.059	1.554	1.197	1.020,26
30	1.380	1.797	1.357	1.044	928,00	2.130	1.608	1.238	1.054,00
31	1.426	1.857	1.402	1.079	957,54	2.201	1.662	1.279	1.087,74
32	1.472	1.917	1.447	1.114	987,08	2.272	1.715	1.320	1.121,48
33	1.518	1.977	1.492	1.149	1.016,62	2.343	1.769	1.362	1.155,22
34	1.564	2.037	1.537	1.184	1.046,16	2.414	1.822	1.403	1.188,96
35	1.610	2.097	1.583	1.218	1.075,70	2.485	1.876	1.444	1.222,70
36	1.656	2.156	1.628	1.253	1.105,24	2.556	1.930	1.485	1.256,44
37	1.702	2.216	1.673	1.288	1.134,78	2.627	1.983	1.527	1.290,18
38	1.748	2.276	1.718	1.323	1.164,32	2.698	2.037	1.568	1.323,92
39	1.794	2.336	1.764	1.358	1.193,86	2.769	2.090	1.609	1.357,66
40	1.840	2.396	1.809	1.392	1.237,32	2.840	2.144	1.650	1.405,32

Precios para color blanco estándar RAL 9016.

Precios para carta de colores Zehnder +25%. Otros colores, consultar.



# Zehnder Charleston

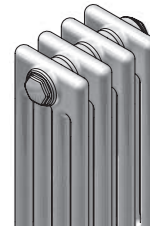
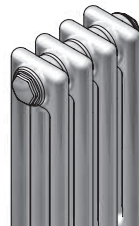
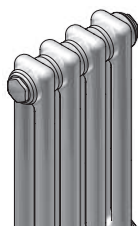
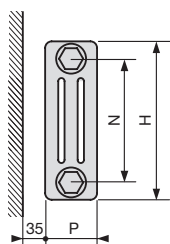

MODELO	2040	3040	4040
Altura H	400 mm	400 mm	400 mm
Entre ejes N	334 mm	334 mm	334 mm
Profundidad P	62 mm	100 mm	136 mm
Exponente n	1,24	1,25	1,26

Recuerde pedir el Pack de Conexión

Longitud L	Elem.	mm	Emisión	Emisión	Emisión	Blanco	Emisión	Emisión	Emisión	Blanco	Emisión	Emisión	Emisión	Blanco
			EN 442 75/65/20 ΔT 50K W	Caldera condens. ΔT 40K W	Bomba de calor ΔT 32,5K W	RAL 9016 PVP €	EN 442 75/65/20 ΔT 50K W	Caldera condens. ΔT 40K W	Bomba de calor ΔT 32,5K W	RAL 9016 PVP €	EN 442 75/65/20 ΔT 50K W	Caldera condens. ΔT 40K W	Bomba de calor ΔT 32,5K W	RAL 9016 PVP €
4	184	125	95	73	97,51	168	127	98	104,79	220	166	128	126,27	
5	230	156	118	91	114,92	210	159	122	124,02	275	207	160	150,87	
6	276	187	142	110	132,33	251	190	147	143,25	329	249	191	175,47	
7	322	218	166	128	149,74	293	222	171	162,48	384	290	223	200,07	
8	368	250	189	146	167,15	335	254	196	181,71	439	332	255	224,67	
9	414	281	213	165	184,56	377	285	220	200,94	494	373	287	249,27	
10	460	312	237	183	201,97	419	317	245	220,17	549	414	319	273,87	
11	506	343	260	201	219,38	461	349	269	239,40	604	456	351	298,47	
12	552	374	284	219	236,79	503	380	293	258,63	659	497	383	323,07	
13	598	406	308	238	254,20	545	412	318	277,86	714	539	415	347,67	
14	644	437	331	256	271,61	587	444	342	297,09	769	580	447	372,27	
15	690	468	355	274	289,02	629	476	367	316,32	824	622	479	396,87	
16	736	499	379	293	306,43	670	507	391	335,55	878	663	510	421,47	
17	782	530	402	311	323,84	712	539	416	354,78	933	705	542	446,07	
18	828	562	426	329	341,25	754	571	440	374,01	988	746	574	470,67	
19	874	593	450	347	358,66	796	602	465	393,24	1.043	787	606	495,27	
20	920	624	473	366	376,07	838	634	489	412,47	1.098	829	638	519,87	
21	966	655	497	384	393,48	880	666	514	431,70	1.153	870	670	544,47	
22	1.012	686	520	402	410,89	922	697	538	450,93	1.208	912	702	569,07	
23	1.058	718	544	421	428,30	964	729	562	470,16	1.263	953	734	593,67	
24	1.104	749	568	439	445,71	1.006	761	587	489,39	1.318	995	766	618,27	
25	1.150	780	591	457	463,12	1.048	793	611	508,62	1.373	1.036	798	642,87	
26	1.196	811	615	475	480,53	1.089	824	636	527,85	1.427	1.078	830	667,47	
27	1.242	842	639	494	497,94	1.131	856	660	547,08	1.482	1.119	861	692,07	
28	1.288	874	662	512	515,35	1.173	888	685	566,31	1.537	1.160	893	716,67	
29	1.334	905	686	530	532,76	1.215	919	709	585,54	1.592	1.202	925	741,27	
30	1.380	936	710	549	550,17	1.257	951	734	604,77	1.647	1.243	957	765,87	
31	1.426	967	733	567	567,58	1.299	983	758	624,00	1.702	1.285	989	790,47	
32	1.472	998	757	585	585,00	1.341	1.014	783	643,23	1.757	1.326	1.021	815,07	
33	1.518	1.030	781	604	602,41	1.383	1.046	807	662,46	1.812	1.368	1.053	839,67	
34	1.564	1.061	804	622	620,82	1.425	1.078	831	681,69	1.867	1.409	1.085	864,27	
35	1.610	1.092	828	640	639,23	1.467	1.110	856	700,92	1.922	1.451	1.117	888,87	
36	1.656	1.123	852	658	657,64	1.508	1.141	880	720,15	1.977	1.492	1.149	913,47	
37	1.702	1.154	875	677	676,05	1.550	1.173	905	739,38	2.032	1.533	1.180	938,07	
38	1.748	1.186	899	695	694,46	1.592	1.205	929	758,61	2.087	1.575	1.212	962,67	
39	1.794	1.217	923	713	712,87	1.634	1.236	954	777,84	2.142	1.616	1.244	987,27	
40	1.840	1.248	946	732	731,28	1.676	1.268	978	797,07	2.197	1.658	1.276	1.011,87	

Precios para color blanco estándar RAL 9016.

Precios para carta de colores Zehnder +25%. Otros colores, consultar.





# Zehnder Charleston

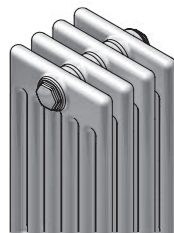
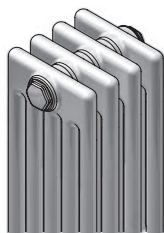
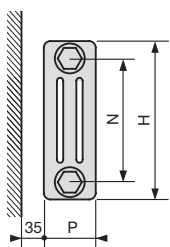

MODELO	5040	6040
Altura H	400 mm	400 mm
Entre ejes N	334 mm	334 mm
Profundidad P	173 mm	210 mm
Exponente n	1,26	1,27

Recuerde pedir el Pack de Conexión

Longitud L	Emisión EN 442 75/65/20 ΔT 50K	Emisión Caldera condens. ΔT 40K	Emisión Bomba de calor ΔT 32,5K	Blanco RAL 9016	Emisión EN 442 75/65/20 ΔT 50K	Emisión Caldera condens. ΔT 40K	Emisión Bomba de calor ΔT 32,5K	Blanco RAL 9016	
Elem. mm	W	W	W	PVP €	W	W	W	PVP €	
4	184	272	205	158	146,03	322	243	186	161,55
5	230	340	256	197	175,57	403	303	233	194,97
6	276	407	308	237	205,11	483	364	279	228,39
7	322	475	359	276	234,65	564	424	326	261,81
8	368	543	410	316	264,19	644	485	373	295,23
9	414	611	461	355	293,73	725	546	419	328,65
10	460	679	513	395	323,27	805	606	466	362,07
11	506	747	564	434	352,81	886	667	512	395,49
12	552	815	615	474	382,35	966	728	559	428,91
13	598	883	666	513	411,89	1.047	788	606	462,33
14	644	951	718	552	441,43	1.127	849	652	495,75
15	690	1.019	769	592	470,97	1.208	910	699	529,17
16	736	1.086	820	631	500,51	1.288	970	745	562,59
17	782	1.154	871	671	530,05	1.369	1.031	792	596,01
18	828	1.222	923	710	559,59	1.449	1.091	838	629,43
19	874	1.290	974	750	589,13	1.530	1.152	885	662,85
20	920	1.358	1.025	789	618,67	1.610	1.213	932	696,27
21	966	1.426	1.076	829	648,21	1.691	1.273	978	729,69
22	1.012	1.494	1.128	868	677,75	1.771	1.334	1.025	763,11
23	1.058	1.562	1.179	908	721,22	1.852	1.395	1.071	810,46
24	1.104	1.630	1.230	947	750,76	1.932	1.455	1.118	843,88
25	1.150	1.698	1.281	986	780,30	2.013	1.516	1.164	877,30
26	1.196	1.765	1.333	1.026	809,84	2.093	1.576	1.211	910,72
27	1.242	1.833	1.384	1.065	839,38	2.174	1.637	1.258	944,14
28	1.288	1.901	1.435	1.105	868,92	2.254	1.698	1.304	977,56
29	1.334	1.969	1.486	1.144	898,46	2.335	1.758	1.351	1.010,98
30	1.380	2.037	1.538	1.184	928,00	2.415	1.819	1.397	1.044,40
31	1.426	2.105	1.589	1.223	957,54	2.496	1.880	1.444	1.077,82
32	1.472	2.173	1.640	1.263	987,08	2.576	1.940	1.491	1.111,24
33	1.518	2.241	1.692	1.302	1.016,62	2.657	2.001	1.537	1.144,66
34	1.564	2.309	1.743	1.342	1.046,16	2.737	2.062	1.584	1.178,08
35	1.610	2.377	1.794	1.381	1.075,70	2.818	2.122	1.630	1.211,50
36	1.656	2.444	1.845	1.421	1.105,24	2.898	2.183	1.677	1.244,92
37	1.702	2.512	1.897	1.460	1.134,78	2.979	2.243	1.723	1.278,34
38	1.748	2.580	1.948	1.499	1.164,32	3.059	2.304	1.770	1.311,76
39	1.794	2.648	1.999	1.539	1.193,86	3.140	2.365	1.817	1.345,18
40	1.840	2.716	2.050	1.578	1.237,32	3.220	2.425	1.863	1.392,52

Precios para color blanco estándar RAL 9016.

Precios para carta de colores Zehnder +25%. Otros colores, consultar.



# Zehnder Charleston

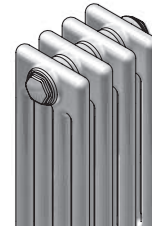
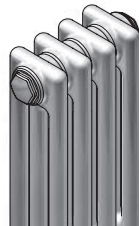
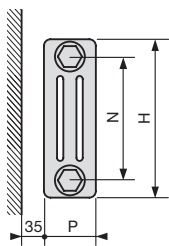

MODELO	2045	3045	4045
Altura H	450 mm	450 mm	450 mm
Entre ejes N	384 mm	384 mm	384 mm
Profundidad P	62 mm	100 mm	136 mm
Exponente n	1,24	1,25	1,26

Recuerde pedir el Pack de Conexión

Longitud L	Elem.	mm	Emisión	Emisión	Emisión	Blanco	Emisión	Emisión	Emisión	Blanco	Emisión	Emisión	Emisión	Blanco
			EN 442 75/65/20 ΔT 50K W	Caldera condens. ΔT 40K W	Bomba de calor ΔT 32,5K W	RAL 9016 PVP €	EN 442 75/65/20 ΔT 50K W	Caldera condens. ΔT 40K W	Bomba de calor ΔT 32,5K W	RAL 9016 PVP €	EN 442 75/65/20 ΔT 50K W	Caldera condens. ΔT 40K W	Bomba de calor ΔT 32,5K W	RAL 9016 PVP €
4	184	140	106	82	97,51	187	142	109	104,79	245	185	142	126,27	
5	230	175	132	102	114,92	234	177	137	124,02	307	231	178	150,87	
6	276	209	159	123	132,33	281	212	164	143,25	368	278	214	175,47	
7	322	244	185	143	149,74	328	248	191	162,48	429	324	249	200,07	
8	368	279	212	164	167,15	374	283	219	181,71	490	370	285	224,67	
9	414	314	238	184	184,56	421	319	246	200,94	552	416	321	249,27	
10	460	349	265	205	201,97	468	354	273	220,17	613	463	356	273,87	
11	506	384	291	225	219,38	515	389	300	239,40	674	509	392	298,47	
12	552	419	318	245	236,79	562	425	328	258,63	736	555	427	323,07	
13	598	454	344	266	254,20	608	460	355	277,86	797	602	463	347,67	
14	644	489	370	286	271,61	655	496	382	297,09	858	648	499	372,27	
15	690	524	397	307	289,02	702	531	410	316,32	920	694	534	396,87	
16	736	558	423	327	306,43	749	567	437	335,55	981	740	570	421,47	
17	782	593	450	348	323,84	796	602	464	354,78	1.042	787	606	446,07	
18	828	628	476	368	341,25	842	637	492	374,01	1.103	833	641	470,67	
19	874	663	503	389	358,66	889	673	519	393,24	1.165	879	677	495,27	
20	920	698	529	409	376,07	936	708	546	412,47	1.226	926	712	519,87	
21	966	733	556	430	393,48	983	744	574	431,70	1.287	972	748	544,47	
22	1.012	768	582	450	410,89	1.030	779	601	450,93	1.349	1.018	784	569,07	
23	1.058	803	609	471	428,30	1.076	814	628	470,16	1.410	1.064	819	593,67	
24	1.104	838	635	491	445,71	1.123	850	656	490,39	1.471	1.111	855	618,27	
25	1.150	873	662	511	463,12	1.170	885	683	510,62	1.533	1.157	891	642,87	
26	1.196	907	688	532	480,53	1.217	921	710	530,85	1.594	1.203	926	667,47	
27	1.242	942	715	552	497,94	1.264	956	737	551,08	1.655	1.249	962	692,07	
28	1.288	977	741	573	515,35	1.310	991	765	571,31	1.716	1.296	997	716,67	
29	1.334	1.012	767	593	532,76	1.357	1.027	792	591,54	1.778	1.342	1.033	741,27	
30	1.380	1.047	794	614	550,17	1.404	1.062	819	611,77	1.839	1.388	1.069	765,87	
31	1.426	1.082	820	634	567,58	1.451	1.098	847	631,00	1.900	1.435	1.104	790,47	
32	1.472	1.117	847	655	585,00	1.498	1.133	874	646,23	1.962	1.481	1.140	815,07	
33	1.518	1.152	873	675	602,41	1.544	1.168	901	657,46	2.023	1.527	1.176	839,67	
34	1.564	1.187	900	696	620,82	1.591	1.204	929	668,69	2.084	1.573	1.211	864,27	
35	1.610	1.222	926	716	638,23	1.638	1.239	956	680,92	2.146	1.620	1.247	888,87	
36	1.656	1.256	953	736	655,64	1.685	1.275	983	693,15	2.207	1.666	1.282	913,47	
37	1.702	1.291	979	757	673,05	1.732	1.310	1.011	705,38	2.268	1.712	1.318	938,07	
38	1.748	1.326	1.006	777	690,46	1.778	1.346	1.038	717,61	2.329	1.758	1.354	962,67	
39	1.794	1.361	1.032	798	707,87	1.825	1.381	1.065	729,84	2.391	1.805	1.389	987,27	
40	1.840	1.396	1.059	818	725,28	1.872	1.416	1.093	742,07	2.452	1.851	1.425	1.011,87	

Precios para color blanco estándar RAL 9016.

Precios para carta de colores Zehnder +25%. Otros colores, consultar.



# Zehnder Charleston

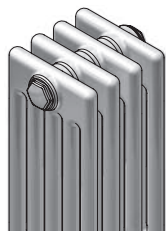
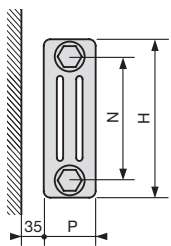

MODELO	5045	6045
Altura H	450 mm	450 mm
Entre ejes N	384 mm	384 mm
Profundidad P	173 mm	210 mm
Exponente n	1,26	1,27

Recuerde pedir el Pack de Conexión

Longitud L	Emisión EN 442 75/65/20 ΔT 50K W	Emisión Caldera condens. ΔT 40K W	Emisión Bomba de calor ΔT 32,5K W	Blanco RAL 9016 PVP €	Emisión EN 442 75/65/20 ΔT 50K W	Emisión Caldera condens. ΔT 40K W	Emisión Bomba de calor ΔT 32,5K W	Blanco RAL 9016 PVP €	
4	184	303	229	176	146,03	359	271	208	157,67
5	230	379	286	220	175,57	449	338	260	190,12
6	276	455	343	264	205,11	539	406	312	222,57
7	322	531	401	308	234,65	629	473	364	255,02
8	368	606	458	352	264,19	718	541	416	287,47
9	414	682	515	396	293,73	808	609	468	319,92
10	460	758	572	440	323,27	898	676	520	352,37
11	506	834	629	485	352,81	988	744	572	384,82
12	552	910	687	529	382,35	1.078	812	624	417,27
13	598	985	744	573	411,89	1.167	879	675	449,72
14	644	1.061	801	617	441,43	1.257	947	727	482,17
15	690	1.137	858	661	470,97	1.347	1.015	779	514,62
16	736	1.213	916	705	500,51	1.437	1.082	831	547,07
17	782	1.289	973	749	530,05	1.527	1.150	883	579,52
18	828	1.364	1.030	793	559,59	1.616	1.218	935	611,97
19	874	1.440	1.087	837	589,13	1.706	1.285	987	644,42
20	920	1.516	1.144	881	618,67	1.796	1.353	1.039	676,87
21	966	1.592	1.202	925	648,21	1.886	1.420	1.091	709,32
22	1.012	1.668	1.259	969	677,75	1.976	1.488	1.143	741,77
23	1.058	1.743	1.316	1.013	721,22	2.065	1.556	1.195	788,15
24	1.104	1.819	1.373	1.057	750,76	2.155	1.623	1.247	820,60
25	1.150	1.895	1.431	1.101	780,30	2.245	1.691	1.299	853,05
26	1.196	1.971	1.488	1.145	809,84	2.335	1.759	1.351	885,50
27	1.242	2.047	1.545	1.189	839,38	2.425	1.826	1.403	917,95
28	1.288	2.122	1.602	1.233	868,92	2.514	1.894	1.455	950,40
29	1.334	2.198	1.659	1.277	898,46	2.604	1.962	1.507	982,85
30	1.380	2.274	1.717	1.321	928,00	2.694	2.029	1.559	1.015,30
31	1.426	2.350	1.774	1.366	957,54	2.784	2.097	1.611	1.047,75
32	1.472	2.426	1.831	1.410	987,08	2.874	2.164	1.663	1.080,20
33	1.518	2.501	1.888	1.454	1.016,62	2.963	2.232	1.715	1.112,65
34	1.564	2.577	1.946	1.498	1.046,16	3.053	2.300	1.767	1.145,10
35	1.610	2.653	2.003	1.542	1.075,70	3.143	2.367	1.819	1.177,55
36	1.656	2.729	2.060	1.586	1.105,24	3.233	2.435	1.871	1.210,00
37	1.702	2.805	2.117	1.630	1.134,78	3.323	2.503	1.923	1.242,45
38	1.748	2.880	2.174	1.674	1.164,32	3.412	2.570	1.975	1.274,90
39	1.794	2.956	2.232	1.718	1.193,86	3.502	2.638	2.026	1.307,35
40	1.840	3.032	2.289	1.762	1.237,32	3.592	2.706	2.078	1.353,72

Precios para color blanco estándar RAL 9016.

Precios para carta de colores Zehnder +25%. Otros colores, consultar.



# Zehnder Charleston

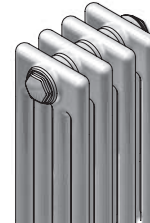
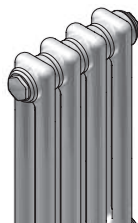
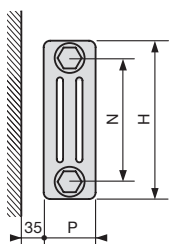

MODELO	2050	3050	4050
Altura H	500 mm	500 mm	500 mm
Entre ejes N	434 mm	434 mm	434 mm
Profundidad P	62 mm	100 mm	136 mm
Exponente n	1,25	1,25	1,26

Recuerde pedir el Pack de Conexión

Longitud L	Elem.	mm	Emisión	Emisión	Emisión	Blanco	Emisión	Emisión	Emisión	Blanco	Emisión	Emisión	Emisión	Blanco
			EN 442 75/65/20 ΔT 50K W	Caldera condens. ΔT 40K W	Bomba de calor ΔT 32,5K W	RAL 9016 PVP €	EN 442 75/65/20 ΔT 50K W	Caldera condens. ΔT 40K W	Bomba de calor ΔT 32,5K W	RAL 9016 PVP €	EN 442 75/65/20 ΔT 50K W	Caldera condens. ΔT 40K W	Bomba de calor ΔT 32,5K W	RAL 9016 PVP €
4	184	154	116	90	99,59	206	156	120	104,79	270	204	157	112,63	
5	230	192	145	112	117,52	258	195	151	124,02	338	255	196	133,82	
6	276	230	174	134	135,45	310	234	181	143,25	406	306	236	155,01	
7	322	269	203	157	153,38	361	273	211	162,48	473	357	275	176,20	
8	368	307	232	179	171,31	413	312	241	181,71	541	408	314	197,39	
9	414	346	261	202	189,24	464	351	271	200,94	608	459	354	218,58	
10	460	384	291	224	207,17	516	390	301	220,17	676	510	393	239,77	
11	506	422	320	247	225,10	568	429	331	239,40	744	561	432	260,96	
12	552	461	349	269	243,03	619	468	361	258,63	811	612	471	282,15	
13	598	499	378	291	260,96	671	508	392	277,86	879	663	511	303,34	
14	644	538	407	314	278,89	722	547	422	297,09	946	714	550	324,53	
15	690	576	436	336	296,82	774	586	452	316,32	1.014	765	589	345,72	
16	736	614	465	359	314,75	826	625	482	335,55	1.082	817	629	366,91	
17	782	653	494	381	332,68	877	664	512	354,78	1.149	868	668	388,10	
18	828	691	523	403	350,61	929	703	542	374,01	1.217	919	707	409,29	
19	874	730	552	426	368,54	980	742	572	393,24	1.284	970	746	430,48	
20	920	768	581	448	386,47	1.032	781	602	412,47	1.352	1.021	786	451,67	
21	966	806	610	471	404,40	1.084	820	632	431,70	1.420	1.072	825	472,86	
22	1.012	845	639	493	422,33	1.135	859	663	450,93	1.487	1.123	864	494,05	
23	1.058	883	668	515	454,19	1.187	898	693	484,09	1.555	1.174	904	529,17	
24	1.104	922	697	538	472,12	1.238	937	723	503,32	1.622	1.225	943	550,36	
25	1.150	960	726	560	490,05	1.290	976	753	522,55	1.690	1.276	982	571,55	
26	1.196	998	755	583	507,98	1.342	1.015	783	541,78	1.758	1.327	1.021	592,74	
27	1.242	1.037	784	605	525,91	1.393	1.054	813	561,01	1.825	1.378	1.061	613,93	
28	1.288	1.075	813	628	543,84	1.445	1.093	843	580,24	1.893	1.429	1.100	635,12	
29	1.334	1.114	843	650	561,77	1.496	1.132	873	599,47	1.960	1.480	1.139	656,31	
30	1.380	1.152	872	672	579,70	1.548	1.171	903	618,70	2.028	1.531	1.179	677,50	
31	1.426	1.190	901	695	597,63	1.600	1.210	934	637,93	2.096	1.582	1.218	698,69	
32	1.472	1.229	930	717	615,56	1.651	1.249	964	657,16	2.163	1.633	1.257	719,88	
33	1.518	1.267	959	740	633,49	1.703	1.288	994	676,39	2.231	1.684	1.296	741,07	
34	1.564	1.306	988	762	651,42	1.754	1.327	1.024	695,62	2.298	1.735	1.336	762,26	
35	1.610	1.344	1.017	784	669,35	1.806	1.366	1.054	714,85	2.366	1.786	1.375	783,45	
36	1.656	1.382	1.046	807	687,28	1.858	1.405	1.084	734,08	2.434	1.837	1.414	804,64	
37	1.702	1.421	1.075	829	705,21	1.909	1.444	1.114	753,31	2.501	1.888	1.454	825,83	
38	1.748	1.459	1.104	852	723,14	1.961	1.484	1.144	772,54	2.569	1.939	1.493	847,02	
39	1.794	1.498	1.133	874	741,07	2.012	1.523	1.175	791,77	2.636	1.990	1.532	868,21	
40	1.840	1.536	1.162	896	772,92	2.064	1.562	1.205	824,92	2.704	2.041	1.571	903,32	

Precios para color blanco estándar RAL 9016.

Precios para carta de colores Zehnder +25%. Otros colores, consultar.



# Zehnder Charleston

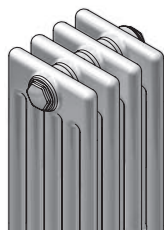
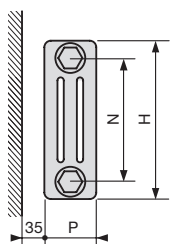

MODELO	5050	6050
Altura H	500 mm	500 mm
Entre ejes N	434 mm	434 mm
Profundidad P	173 mm	210 mm
Exponente n	1,27	1,28

Recuerde pedir el Pack de Conexión

Longitud L	Emisión EN 442 75/65/20 ΔT 50K W	Emisión Caldera condens. ΔT 40K W	Emisión Bomba de calor ΔT 32,5K W	Blanco RAL 9016 PVP €	Emisión EN 442 75/65/20 ΔT 50K W	Emisión Caldera condens. ΔT 40K W	Emisión Bomba de calor ΔT 32,5K W	Blanco RAL 9016 PVP €	
4	184	334	252	193	148,43	396	298	228	159,91
5	230	418	314	242	178,57	495	372	285	192,92
6	276	501	377	290	208,71	594	446	342	225,93
7	322	585	440	338	238,85	693	521	399	258,94
8	368	668	503	387	268,99	792	595	456	291,95
9	414	752	566	435	299,13	891	670	513	324,96
10	460	835	629	483	329,27	990	744	570	357,97
11	506	919	692	531	359,41	1.089	818	627	390,98
12	552	1.002	755	580	389,55	1.188	893	684	423,99
13	598	1.086	818	628	419,69	1.287	967	741	457,00
14	644	1.169	881	676	449,83	1.386	1.042	799	490,01
15	690	1.253	943	725	479,97	1.485	1.116	856	523,02
16	736	1.336	1.006	773	510,11	1.584	1.190	913	556,03
17	782	1.420	1.069	821	540,25	1.683	1.265	970	589,04
18	828	1.503	1.132	870	570,39	1.782	1.339	1.027	622,05
19	874	1.587	1.195	918	600,53	1.881	1.414	1.084	655,06
20	920	1.670	1.258	966	630,67	1.980	1.488	1.141	688,07
21	966	1.754	1.321	1.015	660,81	2.079	1.562	1.198	721,08
22	1.012	1.837	1.384	1.063	690,95	2.178	1.637	1.255	754,09
23	1.058	1.921	1.447	1.111	735,02	2.277	1.711	1.312	801,03
24	1.104	2.004	1.509	1.160	765,16	2.376	1.786	1.369	834,04
25	1.150	2.088	1.572	1.208	795,30	2.475	1.860	1.426	867,05
26	1.196	2.171	1.635	1.256	825,44	2.574	1.934	1.483	900,06
27	1.242	2.255	1.698	1.305	855,58	2.673	2.009	1.540	933,07
28	1.288	2.338	1.761	1.353	885,72	2.772	2.083	1.597	966,08
29	1.334	2.422	1.824	1.401	915,86	2.871	2.158	1.654	999,09
30	1.380	2.505	1.887	1.449	946,00	2.970	2.232	1.711	1.032,10
31	1.426	2.589	1.950	1.498	976,14	3.069	2.306	1.768	1.065,11
32	1.472	2.672	2.013	1.546	1.006,28	3.168	2.381	1.825	1.098,12
33	1.518	2.756	2.076	1.594	1.036,42	3.267	2.455	1.882	1.131,13
34	1.564	2.839	2.138	1.643	1.066,56	3.366	2.530	1.939	1.164,14
35	1.610	2.923	2.201	1.691	1.096,70	3.465	2.604	1.996	1.197,15
36	1.656	3.006	2.264	1.739	1.126,84	3.564	2.679	2.053	1.230,16
37	1.702	3.090	2.327	1.788	1.156,98	3.663	2.753	2.110	1.263,17
38	1.748	3.173	2.390	1.836	1.187,12	3.762	2.827	2.167	1.296,18
39	1.794	3.257	2.453	1.884	1.217,26	3.861	2.902	2.224	1.329,19
40	1.840	3.340	2.516	1.933	1.261,32	3.960	2.976	2.282	1.376,20

Precios para color blanco estándar RAL 9016.

Precios para carta de colores Zehnder +25%. Otros colores, consultar.



# Zehnder Charleston

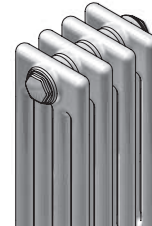
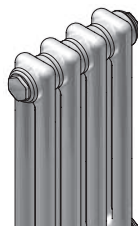
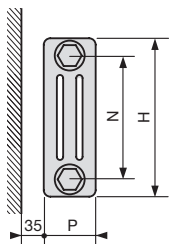

MODELO	2055	3055	4055
Altura H	550 mm	550 mm	550 mm
Entre ejes N	484 mm	484 mm	484 mm
Profundidad P	62 mm	100 mm	136 mm
Exponente n	1,25	1,26	1,26

Recuerde pedir el Pack de Conexión

Longitud L	Elem.	mm	Emisión	Emisión	Emisión	Blanco	Emisión	Emisión	Emisión	Blanco	Emisión	Emisión	Emisión	Blanco
			EN 442 75/65/20 ΔT 50K W	Caldera condens. ΔT 40K W	Bomba de calor ΔT 32,5K W	RAL 9016 PVP €	EN 442 75/65/20 ΔT 50K W	Caldera condens. ΔT 40K W	Bomba de calor ΔT 32,5K W	RAL 9016 PVP €	EN 442 75/65/20 ΔT 50K W	Caldera condens. ΔT 40K W	Bomba de calor ΔT 32,5K W	RAL 9016 PVP €
4	184	168	127	98	99,59	225	170	131	104,79	295	223	171	112,63	
5	230	210	159	122	117,52	282	213	164	124,02	369	278	214	133,82	
6	276	251	190	147	135,45	338	255	196	143,25	442	334	257	155,01	
7	322	293	222	171	153,38	394	298	229	162,48	516	389	300	176,20	
8	368	335	254	196	171,31	450	340	262	181,71	590	445	343	197,39	
9	414	377	285	220	189,24	507	383	294	200,94	663	501	385	218,58	
10	460	419	317	245	207,17	563	425	327	220,17	737	556	428	239,77	
11	506	461	349	269	225,10	619	468	360	239,40	811	612	471	260,96	
12	552	503	380	293	243,03	676	510	393	258,63	884	668	514	282,15	
13	598	545	412	318	260,96	732	553	425	277,86	958	723	557	303,34	
14	644	587	444	342	278,89	788	595	458	297,09	1.032	779	600	324,53	
15	690	629	476	367	296,82	845	638	491	316,32	1.106	835	642	345,72	
16	736	670	507	391	314,75	901	680	523	335,55	1.179	890	685	366,91	
17	782	712	539	416	332,68	957	723	556	354,78	1.253	946	728	388,10	
18	828	754	571	440	350,61	1.013	765	589	374,01	1.327	1.001	771	409,29	
19	874	796	602	465	368,54	1.070	808	622	393,24	1.400	1.057	814	430,48	
20	920	838	634	489	386,47	1.126	850	654	412,47	1.474	1.113	857	451,67	
21	966	880	666	514	404,40	1.182	893	687	431,70	1.548	1.168	899	472,86	
22	1.012	922	697	538	422,33	1.239	935	720	450,93	1.621	1.224	942	494,05	
23	1.058	964	729	562	454,19	1.295	978	753	484,09	1.695	1.280	985	529,17	
24	1.104	1.006	761	587	472,12	1.351	1.020	785	503,32	1.769	1.335	1.028	550,36	
25	1.150	1.048	793	611	490,05	1.408	1.063	818	522,55	1.843	1.391	1.071	571,55	
26	1.196	1.089	824	636	507,98	1.464	1.105	851	541,78	1.916	1.447	1.114	592,74	
27	1.242	1.131	856	660	525,91	1.520	1.148	883	561,01	1.990	1.502	1.156	613,93	
28	1.288	1.173	888	685	543,84	1.576	1.190	916	580,24	2.064	1.558	1.199	635,12	
29	1.334	1.215	919	709	561,77	1.633	1.233	949	599,47	2.137	1.613	1.242	656,31	
30	1.380	1.257	951	734	579,70	1.689	1.275	982	618,70	2.211	1.669	1.285	677,50	
31	1.426	1.299	983	758	597,63	1.745	1.318	1.014	637,93	2.285	1.725	1.328	698,69	
32	1.472	1.341	1.014	783	615,56	1.802	1.360	1.047	657,16	2.358	1.780	1.371	719,88	
33	1.518	1.383	1.046	807	633,49	1.858	1.403	1.080	676,39	2.432	1.836	1.413	741,07	
34	1.564	1.425	1.078	831	651,42	1.914	1.445	1.112	695,62	2.506	1.892	1.456	762,26	
35	1.610	1.467	1.110	856	669,35	1.971	1.488	1.145	714,85	2.580	1.947	1.499	783,45	
36	1.656	1.508	1.141	880	687,28	2.027	1.530	1.178	734,08	2.653	2.003	1.542	804,64	
37	1.702	1.550	1.173	905	705,21	2.083	1.573	1.211	753,31	2.727	2.059	1.585	825,83	
38	1.748	1.592	1.205	929	723,14	2.139	1.615	1.243	772,54	2.801	2.114	1.628	847,02	
39	1.794	1.634	1.236	954	741,07	2.196	1.658	1.276	791,77	2.874	2.170	1.670	868,21	
40	1.840	1.676	1.268	978	772,92	2.252	1.700	1.309	824,92	2.948	2.225	1.713	903,32	

Precios para color blanco estándar RAL 9016.

Precios para carta de colores Zehnder +25%. Otros colores, consultar.



# Zehnder Charleston

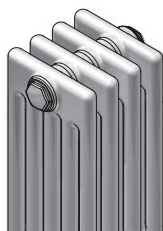
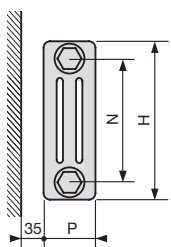

MODELO	5055	6055
Altura H	550 mm	550 mm
Entre ejes N	484 mm	484 mm
Profundidad P	173 mm	210 mm
Exponente n	1,27	1,28

Recuerde pedir el Pack de Conexión

Longitud L	Emisión EN 442 75/65/20 ΔT 50K W	Emisión Caldera condens. ΔT 40K W	Emisión Bomba de calor ΔT 32,5K W	Blanco RAL 9016 PVP €	Emisión EN 442 75/65/20 ΔT 50K W	Emisión Caldera condens. ΔT 40K W	Emisión Bomba de calor ΔT 32,5K W	Blanco RAL 9016 PVP €	
4	184	364	274	211	148,43	432	325	249	160,95
5	230	455	343	263	178,57	540	406	311	194,22
6	276	546	411	316	208,71	648	487	373	227,49
7	322	637	480	369	238,85	756	568	436	260,76
8	368	728	548	421	268,99	864	649	498	294,03
9	414	819	617	474	299,13	972	731	560	327,30
10	460	910	685	527	329,27	1.080	812	622	360,57
11	506	1.001	754	579	359,41	1.188	893	684	393,84
12	552	1.092	823	632	389,55	1.296	974	747	427,11
13	598	1.183	891	685	419,69	1.404	1.055	809	460,38
14	644	1.274	960	737	449,83	1.512	1.136	871	493,65
15	690	1.365	1.028	790	479,97	1.620	1.218	933	526,92
16	736	1.456	1.097	842	510,11	1.728	1.299	996	560,19
17	782	1.547	1.165	895	540,25	1.836	1.380	1.058	593,46
18	828	1.638	1.234	948	570,39	1.944	1.461	1.120	626,73
19	874	1.729	1.302	1.000	600,53	2.052	1.542	1.182	660,00
20	920	1.820	1.371	1.053	630,67	2.160	1.623	1.244	693,27
21	966	1.911	1.439	1.106	660,81	2.268	1.705	1.307	726,54
22	1.012	2.002	1.508	1.158	690,95	2.376	1.786	1.369	759,81
23	1.058	2.093	1.576	1.211	735,02	2.484	1.867	1.431	807,01
24	1.104	2.184	1.645	1.264	765,16	2.592	1.948	1.493	840,28
25	1.150	2.275	1.714	1.316	795,30	2.700	2.029	1.556	873,55
26	1.196	2.366	1.782	1.369	825,44	2.808	2.110	1.618	906,82
27	1.242	2.457	1.851	1.422	855,58	2.916	2.192	1.680	940,09
28	1.288	2.548	1.919	1.474	885,72	3.024	2.273	1.742	973,36
29	1.334	2.639	1.988	1.527	915,86	3.132	2.354	1.804	1.006,63
30	1.380	2.730	2.056	1.580	946,00	3.240	2.435	1.867	1.039,90
31	1.426	2.821	2.125	1.632	976,14	3.348	2.516	1.929	1.073,17
32	1.472	2.912	2.193	1.685	1.006,28	3.456	2.597	1.991	1.106,44
33	1.518	3.003	2.262	1.738	1.036,42	3.564	2.679	2.053	1.139,71
34	1.564	3.094	2.330	1.790	1.066,56	3.672	2.760	2.116	1.172,98
35	1.610	3.185	2.399	1.843	1.096,70	3.780	2.841	2.178	1.206,25
36	1.656	3.276	2.468	1.896	1.126,84	3.888	2.922	2.240	1.239,52
37	1.702	3.367	2.536	1.948	1.156,98	3.996	3.003	2.302	1.272,79
38	1.748	3.458	2.605	2.001	1.187,12	4.104	3.084	2.364	1.306,06
39	1.794	3.549	2.673	2.054	1.217,26	4.212	3.166	2.427	1.339,33
40	1.840	3.640	2.742	2.106	1.261,32	4.320	3.247	2.489	1.386,52

Precios para color blanco estándar RAL 9016.

Precios para carta de colores Zehnder +25%. Otros colores, consultar.



# Zehnder Charleston

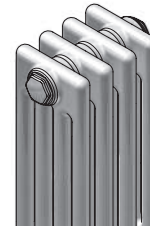
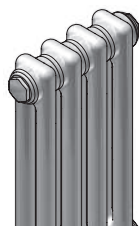
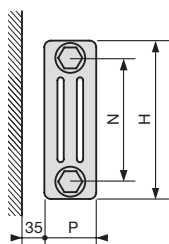

MODELO	2060	3060	4060
Altura H	600 mm	600 mm	600 mm
Entre ejes N	534 mm	534 mm	534 mm
Profundidad P	62 mm	100 mm	136 mm
Exponente n	1,25	1,26	1,27

Recuerde pedir el Pack de Conexión

Longitud L	Elem.	mm	Emisión	Emisión	Emisión	Blanco	Emisión	Emisión	Emisión	Blanco	Emisión	Emisión	Emisión	Blanco
			EN 442 75/65/20 ΔT 50K W	Caldera condens. ΔT 40K W	Bomba de calor ΔT 32,5K W	RAL 9016 PVP €	EN 442 75/65/20 ΔT 50K W	Caldera condens. ΔT 40K W	Bomba de calor ΔT 32,5K W	RAL 9016 PVP €	EN 442 75/65/20 ΔT 50K W	Caldera condens. ΔT 40K W	Bomba de calor ΔT 32,5K W	RAL 9016 PVP €
4	184	181	137	106	99,59	244	184	142	104,79	319	240	185	121,91	
5	230	227	171	132	117,52	305	230	177	124,02	399	301	231	145,42	
6	276	272	206	159	135,45	365	276	212	143,25	479	361	277	168,93	
7	322	317	240	185	153,38	426	322	248	162,48	559	421	323	192,44	
8	368	362	274	212	171,31	487	368	283	181,71	638	481	369	215,95	
9	414	408	308	238	189,24	548	414	319	200,94	718	541	416	239,46	
10	460	453	343	264	207,17	609	460	354	220,17	798	601	462	262,97	
11	506	498	377	291	225,10	670	506	389	239,40	878	661	508	286,48	
12	552	544	411	317	243,03	731	552	425	258,63	958	721	554	309,99	
13	598	589	446	344	260,96	792	598	460	277,86	1.037	781	600	333,50	
14	644	634	480	370	278,89	853	644	495	297,09	1.117	842	646	357,01	
15	690	680	514	397	296,82	914	690	531	316,32	1.197	902	693	380,52	
16	736	725	548	423	314,75	974	736	566	335,55	1.277	962	739	404,03	
17	782	770	583	449	332,68	1.035	782	602	354,78	1.357	1.022	785	427,54	
18	828	815	617	476	350,61	1.096	828	637	374,01	1.436	1.082	831	451,05	
19	874	861	651	502	368,54	1.157	874	672	393,24	1.516	1.142	877	474,56	
20	920	906	685	529	386,47	1.218	919	708	412,47	1.596	1.202	923	498,07	
21	966	951	720	555	404,40	1.279	965	743	431,70	1.676	1.262	970	521,58	
22	1.012	997	754	582	422,33	1.340	1.011	779	450,93	1.756	1.322	1.016	545,09	
23	1.058	1.042	788	608	454,19	1.401	1.057	814	484,09	1.835	1.382	1.062	582,53	
24	1.104	1.087	823	635	472,12	1.462	1.103	849	503,32	1.915	1.443	1.108	606,04	
25	1.150	1.133	857	661	490,05	1.523	1.149	885	522,55	1.995	1.503	1.154	629,55	
26	1.196	1.178	891	687	507,98	1.583	1.195	920	541,78	2.075	1.563	1.201	653,06	
27	1.242	1.223	925	714	525,91	1.644	1.241	956	561,01	2.155	1.623	1.247	676,57	
28	1.288	1.268	960	740	543,84	1.705	1.287	991	580,24	2.234	1.683	1.293	700,08	
29	1.334	1.314	994	767	561,77	1.766	1.333	1.026	599,47	2.314	1.743	1.339	723,59	
30	1.380	1.359	1.028	793	579,70	1.827	1.379	1.062	618,70	2.394	1.803	1.385	747,10	
31	1.426	1.404	1.062	820	597,63	1.888	1.425	1.097	637,93	2.474	1.863	1.431	770,61	
32	1.472	1.450	1.097	846	615,56	1.949	1.471	1.132	657,16	2.554	1.923	1.478	794,12	
33	1.518	1.495	1.131	872	633,49	2.010	1.517	1.168	676,39	2.633	1.984	1.524	817,63	
34	1.564	1.540	1.165	899	651,42	2.071	1.563	1.203	695,62	2.713	2.044	1.570	841,14	
35	1.610	1.586	1.200	925	669,35	2.132	1.609	1.239	714,85	2.793	2.104	1.616	864,65	
36	1.656	1.631	1.234	952	687,28	2.192	1.655	1.274	734,08	2.873	2.164	1.662	888,16	
37	1.702	1.676	1.268	978	705,21	2.253	1.701	1.309	753,31	2.953	2.224	1.708	911,67	
38	1.748	1.721	1.302	1.005	723,14	2.314	1.747	1.345	772,54	3.032	2.284	1.755	935,18	
39	1.794	1.767	1.337	1.031	741,07	2.375	1.793	1.380	791,77	3.112	2.344	1.801	958,69	
40	1.840	1.812	1.371	1.058	772,92	2.436	1.839	1.416	824,92	3.192	2.404	1.847	996,12	

Precios para color blanco estándar RAL 9016.

Precios para carta de colores Zehnder +25%. Otros colores, consultar.





# Zehnder Charleston

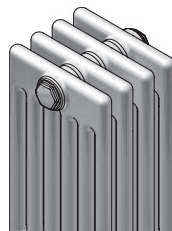
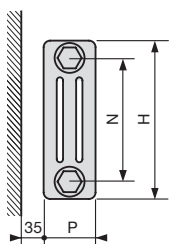

MODELO	5060	6060
Altura H	600 mm	600 mm
Entre ejes N	534 mm	534 mm
Profundidad P	173 mm	210 mm
Exponente n	1,27	1,29

Recuerde pedir el Pack de Conexión

Longitud L	Emisión EN 442 75/65/20 ΔT 50K W	Emisión Caldera condens. ΔT 40K W	Emisión Bomba de calor ΔT 32,5K W	Blanco RAL 9016 PVP €	Emisión EN 442 75/65/20 ΔT 50K W	Emisión Caldera condens. ΔT 40K W	Emisión Bomba de calor ΔT 32,5K W	Blanco RAL 9016 PVP €	
4	184	394	297	228	148,43	468	351	268	160,95
5	230	493	371	285	178,57	585	439	336	194,22
6	276	592	446	342	208,71	702	526	403	227,49
7	322	690	520	399	238,85	819	614	470	260,76
8	368	789	594	456	268,99	936	702	537	294,03
9	414	887	668	513	299,13	1.053	790	604	327,30
10	460	986	743	571	329,27	1.170	877	671	360,57
11	506	1.085	817	628	359,41	1.287	965	738	393,84
12	552	1.183	891	685	389,55	1.404	1.053	805	427,11
13	598	1.282	965	742	419,69	1.521	1.141	873	460,38
14	644	1.380	1.040	799	449,83	1.638	1.228	940	493,65
15	690	1.479	1.114	856	479,97	1.755	1.316	1.007	526,92
16	736	1.578	1.188	913	510,11	1.872	1.404	1.074	560,19
17	782	1.676	1.263	970	540,25	1.989	1.491	1.141	593,46
18	828	1.775	1.337	1.027	570,39	2.106	1.579	1.208	626,73
19	874	1.873	1.411	1.084	600,53	2.223	1.667	1.275	660,00
20	920	1.972	1.485	1.141	630,67	2.340	1.755	1.342	693,27
21	966	2.071	1.560	1.198	660,81	2.457	1.842	1.409	726,54
22	1.012	2.169	1.634	1.255	690,95	2.574	1.930	1.477	759,81
23	1.058	2.268	1.708	1.312	735,02	2.691	2.018	1.544	807,01
24	1.104	2.366	1.782	1.369	765,16	2.808	2.106	1.611	840,28
25	1.150	2.465	1.857	1.426	795,30	2.925	2.193	1.678	873,55
26	1.196	2.564	1.931	1.483	825,44	3.042	2.281	1.745	906,82
27	1.242	2.662	2.005	1.540	855,58	3.159	2.369	1.812	940,09
28	1.288	2.761	2.080	1.597	885,72	3.276	2.457	1.879	973,36
29	1.334	2.859	2.154	1.655	915,86	3.393	2.544	1.946	1.006,63
30	1.380	2.958	2.228	1.712	946,00	3.510	2.632	2.014	1.039,90
31	1.426	3.057	2.302	1.769	976,14	3.627	2.720	2.081	1.073,17
32	1.472	3.155	2.377	1.826	1.006,28	3.744	2.808	2.148	1.106,44
33	1.518	3.254	2.451	1.883	1.036,42	3.861	2.895	2.215	1.139,71
34	1.564	3.352	2.525	1.940	1.066,56	3.978	2.983	2.282	1.172,98
35	1.610	3.451	2.599	1.997	1.096,70	4.095	3.071	2.349	1.206,25
36	1.656	3.550	2.674	2.054	1.126,84	4.212	3.158	2.416	1.239,52
37	1.702	3.648	2.748	2.111	1.156,98	4.329	3.246	2.483	1.272,79
38	1.748	3.747	2.822	2.168	1.187,12	4.446	3.334	2.551	1.306,06
39	1.794	3.845	2.896	2.225	1.217,26	4.563	3.422	2.618	1.339,33
40	1.840	3.944	2.971	2.282	1.261,32	4.680	3.509	2.685	1.386,52

Precios para color blanco estándar RAL 9016.

Precios para carta de colores Zehnder +25%. Otros colores, consultar.



# Zehnder Charleston

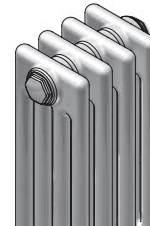
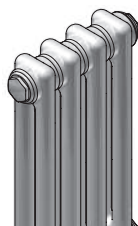
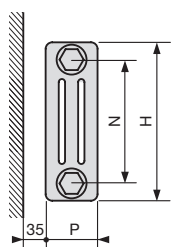

MODELO	2075	3075	4075
Altura H	750 mm	750 mm	750 mm
Entre ejes N	684 mm	684 mm	684 mm
Profundidad P	62 mm	100 mm	136 mm
Exponente n	1,25	1,26	1,27

Recuerde pedir el Pack de Conexión

Longitud L	Elem.	mm	Emisión	Emisión	Emisión	Blanco	Emisión	Emisión	Emisión	Blanco	Emisión	Emisión	Emisión	Blanco
			EN 442 75/65/20 ΔT 50K W	Caldera condens. ΔT 40K W	Bomba de calor ΔT 32,5K W	RAL 9016 PVP €	EN 442 75/65/20 ΔT 50K W	Caldera condens. ΔT 40K W	Bomba de calor ΔT 32,5K W	RAL 9016 PVP €	EN 442 75/65/20 ΔT 50K W	Caldera condens. ΔT 40K W	Bomba de calor ΔT 32,5K W	RAL 9016 PVP €
4	184	220	166	128	104,63	297	224	173	115,91	390	293	225	133,67	
5	230	275	208	160	123,82	372	280	216	137,92	487	367	282	160,12	
6	276	330	250	193	143,01	446	337	259	159,93	584	440	338	186,57	
7	322	385	291	225	162,20	520	393	302	181,94	682	514	395	213,02	
8	368	440	333	257	181,39	594	449	345	203,95	779	587	451	239,47	
9	414	495	375	289	200,58	669	505	389	225,96	877	660	507	265,92	
10	460	550	416	321	219,77	743	561	432	247,97	974	734	564	292,37	
11	506	605	458	353	238,96	817	617	475	269,98	1.071	807	620	318,82	
12	552	660	499	385	258,15	892	673	518	291,99	1.169	880	676	345,27	
13	598	715	541	417	277,34	966	729	561	314,00	1.266	954	733	371,72	
14	644	770	583	449	296,53	1.040	785	604	336,01	1.364	1.027	789	398,17	
15	690	825	624	481	315,72	1.115	841	648	358,02	1.461	1.100	845	424,62	
16	736	880	666	514	334,91	1.189	897	691	380,03	1.558	1.174	902	451,07	
17	782	935	707	546	354,10	1.263	954	734	402,04	1.656	1.247	958	477,52	
18	828	990	749	578	373,29	1.337	1.010	777	424,05	1.753	1.321	1.014	503,97	
19	874	1.045	791	610	392,48	1.412	1.066	820	446,06	1.851	1.394	1.071	530,42	
20	920	1.100	832	642	411,67	1.486	1.122	864	468,07	1.948	1.467	1.127	556,87	
21	966	1.155	874	674	430,86	1.560	1.178	907	490,08	2.045	1.541	1.184	583,32	
22	1.012	1.210	915	706	450,05	1.635	1.234	950	512,09	2.143	1.614	1.240	609,77	
23	1.058	1.265	957	738	469,24	1.709	1.290	993	534,10	2.240	1.687	1.296	636,32	
24	1.104	1.320	999	770	488,43	1.783	1.346	1.036	556,11	2.338	1.761	1.353	662,87	
25	1.150	1.375	1.040	802	507,62	1.858	1.402	1.079	578,12	2.435	1.834	1.409	689,42	
26	1.196	1.430	1.082	835	526,81	1.932	1.458	1.123	600,13	2.532	1.907	1.465	715,97	
27	1.242	1.485	1.124	867	546,00	2.006	1.514	1.166	622,14	2.630	1.981	1.522	742,52	
28	1.288	1.540	1.165	899	565,19	2.080	1.571	1.209	644,15	2.727	2.054	1.578	769,07	
29	1.334	1.595	1.207	931	584,38	2.155	1.627	1.252	666,16	2.825	2.128	1.634	795,62	
30	1.380	1.650	1.248	963	603,57	2.229	1.683	1.295	688,17	2.922	2.201	1.691	822,17	
31	1.426	1.705	1.290	995	622,76	2.303	1.739	1.339	710,18	3.019	2.274	1.747	848,72	
32	1.472	1.760	1.332	1.027	641,95	2.378	1.795	1.382	732,19	3.117	2.348	1.803	875,27	
33	1.518	1.815	1.373	1.059	661,14	2.452	1.851	1.425	754,20	3.214	2.421	1.860	901,82	
34	1.564	1.870	1.415	1.091	680,33	2.526	1.907	1.468	776,21	3.312	2.494	1.916	928,37	
35	1.610	1.925	1.456	1.123	699,52	2.601	1.963	1.511	798,22	3.409	2.568	1.973	954,92	
36	1.656	1.980	1.498	1.156	718,71	2.675	2.019	1.554	820,23	3.506	2.641	2.029	981,47	
37	1.702	2.035	1.540	1.188	737,90	2.749	2.075	1.598	842,24	3.604	2.714	2.085	1.008,02	
38	1.748	2.090	1.581	1.220	757,09	2.823	2.131	1.641	864,25	3.701	2.788	2.142	1.034,57	
39	1.794	2.145	1.623	1.252	776,28	2.898	2.187	1.684	886,26	3.799	2.861	2.198	1.061,12	
40	1.840	2.200	1.665	1.284	795,47	2.972	2.244	1.727	908,27	3.896	2.935	2.254	1.087,67	

Precios para color blanco estándar RAL 9016.

Precios para carta de colores Zehnder +25%. Otros colores, consultar.



# Zehnder Charleston

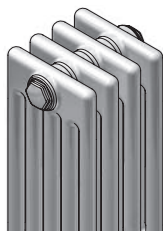
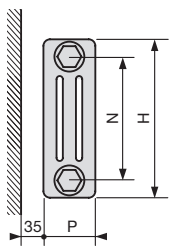

MODELO	5075	6075
Altura H	750 mm	750 mm
Entre ejes N	684 mm	684 mm
Profundidad P	173 mm	210 mm
Exponente n	1,29	1,30

Recuerde pedir el Pack de Conexión

Longitud L	Emisión EN 442 75/65/20 ΔT 50K W	Emisión Caldera condens. ΔT 40K W	Emisión Bomba de calor ΔT 32,5K W	Blanco RAL 9016 PVP €	Emisión EN 442 75/65/20 ΔT 50K W	Emisión Caldera condens. ΔT 40K W	Emisión Bomba de calor ΔT 32,5K W	Blanco RAL 9016 PVP €	
4	184	480	360	275	169,11	572	428	327	186,51
5	230	600	450	344	204,42	715	535	408	226,17
6	276	720	540	413	239,73	858	642	490	265,83
7	322	840	630	482	275,04	1.001	749	572	305,49
8	368	960	720	551	310,35	1.144	856	653	345,15
9	414	1.080	810	620	345,66	1.287	963	735	384,81
10	460	1.200	900	688	380,97	1.430	1.070	817	424,47
11	506	1.320	990	757	416,28	1.573	1.177	898	464,13
12	552	1.440	1.080	826	451,59	1.716	1.284	980	503,79
13	598	1.560	1.170	895	486,90	1.859	1.391	1.062	543,45
14	644	1.680	1.260	964	522,21	2.002	1.498	1.144	583,11
15	690	1.800	1.350	1.033	557,52	2.145	1.605	1.225	622,77
16	736	1.920	1.440	1.101	606,76	2.288	1.712	1.307	676,36
17	782	2.040	1.530	1.170	642,07	2.431	1.819	1.389	716,02
18	828	2.160	1.620	1.239	677,38	2.574	1.926	1.470	755,68
19	874	2.280	1.710	1.308	712,69	2.717	2.033	1.552	795,34
20	920	2.400	1.800	1.377	748,00	2.860	2.140	1.634	835,00
21	966	2.520	1.890	1.446	783,31	3.003	2.247	1.715	874,66
22	1.012	2.640	1.980	1.514	818,62	3.146	2.354	1.797	914,32
23	1.058	2.760	2.070	1.583	853,93	3.289	2.461	1.879	953,98
24	1.104	2.880	2.160	1.652	889,24	3.432	2.568	1.960	993,64
25	1.150	3.000	2.250	1.721	924,55	3.575	2.675	2.042	1.033,30
26	1.196	3.120	2.340	1.790	959,86	3.718	2.782	2.124	1.072,96
27	1.242	3.240	2.430	1.859	995,17	3.861	2.889	2.205	1.112,62
28	1.288	3.360	2.520	1.928	1.030,48	4.004	2.996	2.287	1.152,28
29	1.334	3.480	2.610	1.996	1.065,79	4.147	3.103	2.369	1.191,94
30	1.380	3.600	2.700	2.065	1.115,02	4.290	3.210	2.450	1.245,52
31	1.426	3.720	2.790	2.134	1.150,33	4.433	3.317	2.532	1.285,18
32	1.472	3.840	2.880	2.203	1.185,64	4.576	3.424	2.614	1.324,84
33	1.518	3.960	2.969	2.272	1.220,95	4.719	3.531	2.695	1.364,50
34	1.564	4.080	3.059	2.341	1.256,26	4.862	3.638	2.777	1.404,16
35	1.610	4.200	3.149	2.409	1.291,57	5.005	3.745	2.859	1.443,82
36	1.656	4.320	3.239	2.478	1.326,88	5.148	3.852	2.941	1.483,48
37	1.702	4.440	3.329	2.547	1.362,19	5.291	3.959	3.022	1.523,14
38	1.748	4.560	3.419	2.616	1.397,50	5.434	4.066	3.104	1.562,80
39	1.794	4.680	3.509	2.685	1.432,81	5.577	4.173	3.186	1.602,46
40	1.840	4.800	3.599	2.754	1.468,12	5.720	4.280	3.267	1.642,12

Precios para color blanco estándar RAL 9016.

Precios para carta de colores Zehnder +25%. Otros colores, consultar.



# Zehnder Charleston

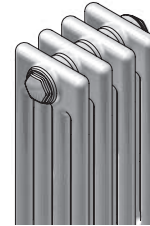
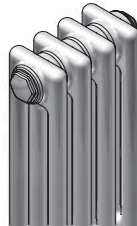
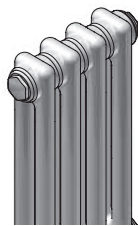
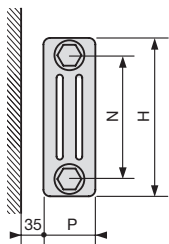

MODELO	2090	3090	4090
Altura H	900 mm	900 mm	900 mm
Entre ejes N	834 mm	834 mm	834 mm
Profundidad P	62 mm	100 mm	136 mm
Exponente n	1,25	1,27	1,28

Recuerde pedir el Pack de Conexión

Longitud L	Elem.	mm	Emisión	Emisión	Emisión	Blanco	Emisión	Emisión	Emisión	Blanco	Emisión	Emisión	Emisión	Blanco
			EN 442 75/65/20 ΔT 50K W	Caldera condens. ΔT 40K W	Bomba de calor ΔT 32,5K W	RAL 9016 PVP €	EN 442 75/65/20 ΔT 50K W	Caldera condens. ΔT 40K W	Bomba de calor ΔT 32,5K W	RAL 9016 PVP €	EN 442 75/65/20 ΔT 50K W	Caldera condens. ΔT 40K W	Bomba de calor ΔT 32,5K W	RAL 9016 PVP €
4	184	256	193	149	111,15	348	262	201	126,03	456	343	263	145,35	
5	230	320	242	186	131,97	435	328	252	150,57	570	428	328	174,72	
6	276	383	290	224	152,79	522	393	302	175,11	684	514	394	204,09	
7	322	447	338	261	173,61	609	459	352	199,65	798	600	460	233,46	
8	368	511	387	298	194,43	696	524	403	224,19	912	685	525	262,83	
9	414	575	435	336	215,25	783	590	453	248,73	1.026	771	591	292,20	
10	460	639	483	373	236,07	870	655	503	273,27	1.140	857	657	321,57	
11	506	703	532	410	256,89	957	721	554	297,81	1.254	942	722	350,94	
12	552	767	580	448	277,71	1.044	786	604	322,35	1.368	1.028	788	380,31	
13	598	831	629	485	298,53	1.131	852	654	346,89	1.482	1.114	854	409,68	
14	644	895	677	522	319,35	1.218	917	705	371,43	1.596	1.199	920	439,05	
15	690	959	725	559	340,17	1.305	983	755	395,97	1.710	1.285	985	468,42	
16	736	1.022	774	597	360,99	1.392	1.048	805	420,51	1.824	1.371	1.051	497,79	
17	782	1.086	822	634	381,81	1.479	1.114	856	445,05	1.938	1.456	1.117	527,16	
18	828	1.150	870	671	402,63	1.566	1.180	906	469,59	2.052	1.542	1.182	556,53	
19	874	1.214	919	709	423,45	1.653	1.245	956	494,13	2.166	1.628	1.248	585,90	
20	920	1.278	967	746	444,27	1.740	1.311	1.007	518,67	2.280	1.714	1.314	615,27	
21	966	1.342	1.015	783	465,09	1.827	1.376	1.057	543,21	2.394	1.799	1.379	644,64	
22	1.012	1.406	1.064	820	485,91	1.914	1.442	1.107	567,75	2.508	1.885	1.445	674,01	
23	1.058	1.470	1.112	858	506,73	2.001	1.507	1.158	592,29	2.622	1.971	1.511	703,38	
24	1.104	1.534	1.160	895	527,55	2.088	1.573	1.208	616,83	2.736	2.056	1.576	732,75	
25	1.150	1.598	1.209	932	548,37	2.175	1.638	1.259	641,37	2.850	2.142	1.642	762,12	
26	1.196	1.661	1.257	970	569,19	2.262	1.704	1.309	665,91	2.964	2.228	1.708	791,49	
27	1.242	1.725	1.305	1.007	589,99	2.349	1.769	1.359	690,45	3.078	2.313	1.773	820,86	
28	1.288	1.789	1.354	1.044	610,79	2.436	1.835	1.410	714,99	3.192	2.399	1.839	850,23	
29	1.334	1.853	1.402	1.082	631,59	2.523	1.900	1.460	739,53	3.306	2.485	1.905	879,60	
30	1.380	1.917	1.450	1.119	652,39	2.610	1.966	1.510	764,07	3.420	2.570	1.970	908,97	
31	1.426	1.981	1.499	1.156	673,19	2.697	2.031	1.561	788,61	3.534	2.656	2.036	938,34	
32	1.472	2.045	1.547	1.193	693,99	2.784	2.097	1.611	813,15	3.648	2.742	2.102	967,71	
33	1.518	2.109	1.595	1.231	714,79	2.871	2.163	1.661	837,69	3.762	2.827	2.167	997,08	
34	1.564	2.173	1.644	1.268	735,59	2.958	2.228	1.712	862,23	3.876	2.913	2.233	1.026,45	
35	1.610	2.237	1.692	1.305	756,39	3.045	2.294	1.762	886,77	3.990	2.999	2.299	1.055,82	
36	1.656	2.300	1.740	1.343	777,19	3.132	2.359	1.812	911,31	4.104	3.084	2.364	1.085,19	
37	1.702	2.364	1.789	1.380	797,99	3.219	2.425	1.863	935,85	4.218	3.170	2.430	1.114,56	
38	1.748	2.428	1.837	1.417	818,79	3.306	2.490	1.913	960,39	4.332	3.256	2.496	1.143,93	
39	1.794	2.492	1.886	1.454	839,59	3.393	2.556	1.963	984,93	4.446	3.341	2.562	1.173,30	
40	1.840	2.556	1.934	1.492	860,39	3.480	2.621	2.014	1.009,47	4.560	3.427	2.627	1.202,67	

Precios para color blanco estándar RAL 9016.

Precios para carta de colores Zehnder +25%. Otros colores, consultar.



# Zehnder Charleston

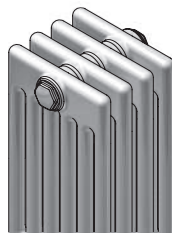
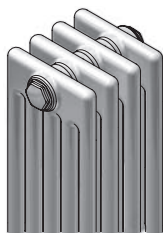
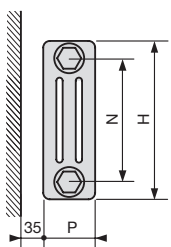

MODELO	5090	6090
Altura H	900 mm	900 mm
Entre ejes N	834 mm	834 mm
Profundidad P	173 mm	210 mm
Exponente n	1,30	1,31

Recuerde pedir el Pack de Conexión

Longitud L	Emisión EN 442 75/65/20 ΔT 50K W	Emisión Caldera condens. ΔT 40K W	Emisión Bomba de calor ΔT 32,5K W	Blanco RAL 9016 PVP €	Emisión EN 442 75/65/20 ΔT 50K W	Emisión Caldera condens. ΔT 40K W	Emisión Bomba de calor ΔT 32,5K W	Blanco RAL 9016 PVP €	
4	184	564	422	322	186,19	668	499	380	220,79
5	230	705	527	403	225,77	835	623	475	269,02
6	276	846	633	483	265,35	1.002	748	570	317,25
7	322	987	738	564	304,93	1.169	873	665	365,48
8	368	1.128	844	644	344,51	1.336	997	760	413,71
9	414	1.269	949	725	384,09	1.503	1.122	855	461,94
10	460	1.410	1.055	805	423,67	1.670	1.247	950	510,17
11	506	1.551	1.160	886	463,25	1.837	1.371	1.045	558,40
12	552	1.692	1.266	966	502,83	2.004	1.496	1.140	606,63
13	598	1.833	1.371	1.047	542,41	2.171	1.621	1.235	654,86
14	644	1.974	1.477	1.128	581,99	2.338	1.745	1.330	703,09
15	690	2.115	1.582	1.208	621,57	2.505	1.870	1.425	751,32
16	736	2.256	1.688	1.289	675,08	2.672	1.995	1.520	813,48
17	782	2.397	1.793	1.369	714,66	2.839	2.119	1.615	861,71
18	828	2.538	1.899	1.450	754,24	3.006	2.244	1.710	909,94
19	874	2.679	2.004	1.530	793,82	3.173	2.369	1.805	958,17
20	920	2.820	2.110	1.611	833,40	3.340	2.493	1.900	1.006,40
21	966	2.961	2.215	1.691	872,98	3.507	2.618	1.995	1.054,63
22	1.012	3.102	2.321	1.772	912,56	3.674	2.743	2.090	1.102,86
23	1.058	3.243	2.426	1.852	952,14	3.841	2.867	2.185	1.151,09
24	1.104	3.384	2.532	1.933	991,72	4.008	2.992	2.280	1.199,32
25	1.150	3.525	2.637	2.013	1.031,30	4.175	3.117	2.375	1.247,55
26	1.196	3.666	2.743	2.094	1.070,88	4.342	3.241	2.469	1.295,78
27	1.242	3.807	2.848	2.175	1.110,46	4.509	3.366	2.564	1.344,01
28	1.288	3.948	2.954	2.255	1.150,04	4.676	3.491	2.659	1.392,24
29	1.334	4.089	3.059	2.336	1.189,62	4.843	3.615	2.754	1.440,47
30	1.380	4.230	3.165	2.416	1.243,12	5.010	3.740	2.849	1.502,62
31	1.426	4.371	3.270	2.497	1.282,70	5.177	3.865	2.944	1.550,85
32	1.472	4.512	3.376	2.577	1.322,28	5.344	3.989	3.039	1.599,08
33	1.518	4.653	3.481	2.658	1.361,86	5.511	4.114	3.134	1.647,31
34	1.564	4.794	3.587	2.738	1.401,44	5.678	4.239	3.229	1.695,54
35	1.610	4.935	3.692	2.819	1.441,02	5.845	4.363	3.324	1.743,77
36	1.656	5.076	3.798	2.899	1.480,60	6.012	4.488	3.419	1.792,00
37	1.702	5.217	3.903	2.980	1.520,18	6.179	4.613	3.514	1.840,23
38	1.748	5.358	4.009	3.060	1.559,76	6.346	4.737	3.609	1.888,46
39	1.794	5.499	4.114	3.141	1.599,34	6.513	4.862	3.704	1.936,69
40	1.840	5.640	4.220	3.222	1.638,92	6.680	4.987	3.799	1.984,92

Precios para color blanco estándar RAL 9016.

Precios para carta de colores Zehnder +25%. Otros colores, consultar.



# Zehnder Charleston

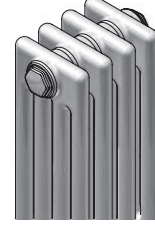
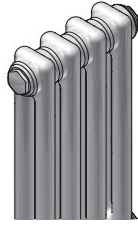
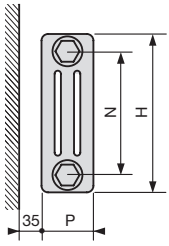

MODELO	2100	3100	4100
Altura H	1.000 mm	1.000 mm	1.000 mm
Entre ejes N	934 mm	934 mm	934 mm
Profundidad P	62 mm	100 mm	136 mm
Exponente n	1,25	1,27	1,29

Recuerde pedir el Pack de Conexión

Longitud L	Elem.	mm	Emisión	Emisión	Emisión	Blanco	Emisión	Emisión	Emisión	Blanco	Emisión	Emisión	Emisión	Blanco
			EN 442 75/65/20 ΔT 50K W	Caldera condens. ΔT 40K W	Bomba de calor ΔT 32,5K W	RAL 9016 PVP €	EN 442 75/65/20 ΔT 50K W	Caldera condens. ΔT 40K W	Bomba de calor ΔT 32,5K W	RAL 9016 PVP €	EN 442 75/65/20 ΔT 50K W	Caldera condens. ΔT 40K W	Bomba de calor ΔT 32,5K W	RAL 9016 PVP €
4	184	278	210	162	118,27	380	287	220	138,27	500	375	287	162,95	
5	230	348	263	203	140,87	476	358	275	165,87	625	469	359	196,72	
6	276	417	315	243	163,47	571	430	330	193,47	750	562	430	230,49	
7	322	487	368	284	186,07	666	501	385	221,07	875	656	502	264,26	
8	368	556	421	325	208,67	761	573	440	248,67	1.000	750	574	298,03	
9	414	626	473	365	231,27	856	645	495	276,27	1.125	844	645	331,80	
10	460	695	526	406	253,87	951	716	550	303,87	1.250	937	717	365,57	
11	506	765	578	446	276,47	1.046	788	605	331,47	1.375	1.031	789	399,34	
12	552	834	631	487	299,07	1.141	860	660	359,07	1.500	1.125	860	433,11	
13	598	904	684	527	321,67	1.236	931	715	386,67	1.625	1.219	932	466,88	
14	644	973	736	568	344,27	1.331	1.003	770	414,27	1.750	1.312	1.004	500,65	
15	690	1.043	789	608	366,87	1.427	1.074	825	441,87	1.875	1.406	1.076	534,42	
16	736	1.112	841	649	389,47	1.522	1.146	880	469,47	2.000	1.500	1.147	568,19	
17	782	1.182	894	690	412,07	1.617	1.218	935	497,07	2.125	1.593	1.219	601,96	
18	828	1.251	946	730	434,67	1.712	1.289	990	524,67	2.250	1.687	1.291	635,73	
19	874	1.321	999	771	457,27	1.807	1.361	1.046	552,27	2.375	1.781	1.362	669,50	
20	920	1.390	1.052	811	479,87	1.902	1.433	1.101	579,87	2.500	1.875	1.434	703,27	
21	966	1.460	1.104	852	502,47	1.997	1.504	1.156	607,47	2.625	1.968	1.506	737,04	
22	1.012	1.529	1.157	892	525,07	2.092	1.576	1.211	635,07	2.750	2.062	1.578	770,81	
23	1.058	1.599	1.209	933	547,67	2.187	1.648	1.266	662,67	2.875	2.156	1.649	804,58	
24	1.104	1.668	1.262	974	570,27	2.282	1.719	1.321	690,27	3.000	2.250	1.721	838,35	
25	1.150	1.738	1.315	1.014	592,87	2.377	1.791	1.376	717,87	3.125	2.343	1.793	872,12	
26	1.196	1.807	1.367	1.055	615,47	2.472	1.862	1.431	745,47	3.250	2.437	1.864	905,89	
27	1.242	1.877	1.420	1.095	638,07	2.567	1.934	1.486	773,07	3.375	2.531	1.936	939,66	
28	1.288	1.946	1.472	1.136	660,67	2.662	2.006	1.541	800,67	3.500	2.625	2.008	973,43	
29	1.334	2.016	1.525	1.176	683,27	2.757	2.077	1.596	828,27	3.625	2.718	2.080	1.007,20	
30	1.380	2.085	1.577	1.217	705,87	2.852	2.149	1.651	855,87	3.750	2.812	2.151	1.040,97	
31	1.426	2.155	1.630	1.257	728,47	2.947	2.221	1.706	883,47	3.875	2.906	2.223	1.074,74	
32	1.472	2.224	1.683	1.298	751,07	3.042	2.292	1.761	911,07	4.000	2.999	2.295	1.108,51	
33	1.518	2.294	1.735	1.339	773,67	3.137	2.364	1.816	938,67	4.125	3.093	2.366	1.142,28	
34	1.564	2.363	1.788	1.379	796,27	3.232	2.435	1.871	966,27	4.250	3.187	2.438	1.176,05	
35	1.610	2.433	1.840	1.420	818,87	3.327	2.507	1.926	993,87	4.375	3.281	2.510	1.209,82	
36	1.656	2.502	1.893	1.460	841,47	3.422	2.579	1.981	1.021,47	4.500	3.374	2.581	1.243,59	
37	1.702	2.572	1.946	1.501	864,07	3.517	2.650	2.036	1.049,07	4.625	3.468	2.653	1.277,36	
38	1.748	2.641	1.998	1.541	886,67	3.612	2.722	2.091	1.076,67	4.750	3.562	2.725	1.311,13	
39	1.794	2.711	2.051	1.582	909,27	3.707	2.794	2.146	1.104,27	4.875	3.656	2.797	1.344,90	
40	1.840	2.780	2.103	1.623	931,87	3.802	2.865	2.201	1.131,87	5.000	3.749	2.868	1.378,67	

Precios para color blanco estándar RAL 9016.

Precios para carta de colores Zehnder +25%. Otros colores, consultar.



# Zehnder Charleston

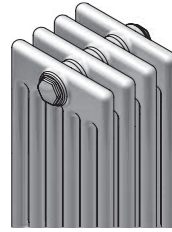
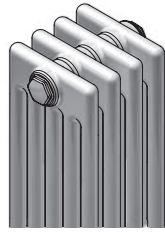
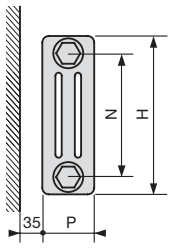

MODELO	5100	6100
Altura H	1.000 mm	1.000 mm
Entre ejes N	934 mm	934 mm
Profundidad P	173 mm	210 mm
Exponente n	1,30	1,31

Recuerde pedir el Pack de Conexión

Longitud L	Emisión EN 442 75/65/20 ΔT 50K W	Emisión Caldera condens. ΔT 40K W	Emisión Bomba de calor ΔT 32,5K W	Blanco RAL 9016 PVP €	Emisión EN 442 75/65/20 ΔT 50K W	Emisión Caldera condens. ΔT 40K W	Emisión Bomba de calor ΔT 32,5K W	Blanco RAL 9016 PVP €	
4	184	616	461	352	197,31	732	546	416	233,11
5	230	770	576	440	239,67	915	683	520	284,42
6	276	924	691	528	282,03	1.098	820	624	335,73
7	322	1.078	807	616	324,39	1.281	956	729	387,04
8	368	1.232	922	704	366,75	1.464	1.093	833	438,35
9	414	1.386	1.037	792	409,11	1.647	1.230	937	489,66
10	460	1.540	1.152	880	451,47	1.830	1.366	1.041	540,97
11	506	1.694	1.267	968	493,83	2.013	1.503	1.145	592,28
12	552	1.848	1.383	1.056	536,19	2.196	1.639	1.249	643,59
13	598	2.002	1.498	1.144	578,55	2.379	1.776	1.353	694,90
14	644	2.156	1.613	1.232	620,91	2.562	1.913	1.457	746,21
15	690	2.310	1.728	1.319	663,27	2.745	2.049	1.561	797,52
16	736	2.464	1.844	1.407	719,56	2.928	2.186	1.665	862,76
17	782	2.618	1.959	1.495	761,92	3.111	2.322	1.769	914,07
18	828	2.772	2.074	1.583	804,28	3.294	2.459	1.873	965,38
19	874	2.926	2.189	1.671	846,64	3.477	2.596	1.978	1.016,69
20	920	3.080	2.304	1.759	889,00	3.660	2.732	2.082	1.068,00
21	966	3.234	2.420	1.847	931,36	3.843	2.869	2.186	1.119,31
22	1.012	3.388	2.535	1.935	973,72	4.026	3.006	2.290	1.170,62
23	1.058	3.542	2.650	2.023	1.016,08	4.209	3.142	2.394	1.221,93
24	1.104	3.696	2.765	2.111	1.058,44	4.392	3.279	2.498	1.273,24
25	1.150	3.850	2.881	2.199	1.100,80	4.575	3.415	2.602	1.324,55
26	1.196	4.004	2.996	2.287	1.143,16	4.758	3.552	2.706	1.375,86
27	1.242	4.158	3.111	2.375	1.185,52	4.941	3.689	2.810	1.427,17
28	1.288	4.312	3.226	2.463	1.227,88	5.124	3.825	2.914	1.478,48
29	1.334	4.466	3.341	2.551	1.270,24	5.307	3.962	3.018	1.529,79
30	1.380	4.620	3.457	2.639	1.326,52	5.490	4.098	3.122	1.595,02
31	1.426	4.774	3.572	2.727	1.368,88	5.673	4.235	3.226	1.646,33
32	1.472	4.928	3.687	2.815	1.411,24	5.856	4.372	3.331	1.697,64
33	1.518	5.082	3.802	2.903	1.453,60	6.039	4.508	3.435	1.748,95
34	1.564	5.236	3.918	2.991	1.495,96	6.222	4.645	3.539	1.800,26
35	1.610	5.390	4.033	3.079	1.538,32	6.405	4.782	3.643	1.851,57
36	1.656	5.544	4.148	3.167	1.580,68	6.588	4.918	3.747	1.902,88
37	1.702	5.698	4.263	3.255	1.623,04	6.771	5.055	3.851	1.954,19
38	1.748	5.852	4.378	3.343	1.665,40	6.954	5.191	3.955	2.005,50
39	1.794	6.006	4.494	3.431	1.707,76	7.137	5.328	4.059	2.056,81
40	1.840	6.160	4.609	3.519	1.750,12	7.320	5.465	4.163	2.108,12

Precios para color blanco estándar RAL 9016.

Precios para carta de colores Zehnder +25%. Otros colores, consultar.



# Zehnder Charleston

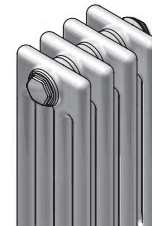
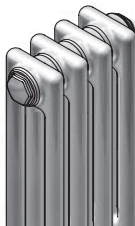
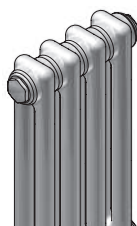
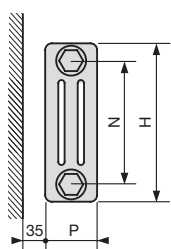

MODELO	2110	3110	4110
Altura H	1.100 mm	1.100 mm	1.100 mm
Entre ejes N	1.034 mm	1.034 mm	1.034 mm
Profundidad P	62 mm	100 mm	136 mm
Exponente n	1,25	1,28	1,29

Recuerde pedir el Pack de Conexión

Longitud L	Elem.	mm	Emisión	Emisión	Emisión	Blanco	Emisión	Emisión	Emisión	Blanco	Emisión	Emisión	Emisión	Blanco
			EN 442 75/65/20 ΔT 50K W	Caldera condens. ΔT 40K W	Bomba de calor ΔT 32,5K W	RAL 9016 PVP €	EN 442 75/65/20 ΔT 50K W	Caldera condens. ΔT 40K W	Bomba de calor ΔT 32,5K W	RAL 9016 PVP €	EN 442 75/65/20 ΔT 50K W	Caldera condens. ΔT 40K W	Bomba de calor ΔT 32,5K W	RAL 9016 PVP €
4	184	299	226	174	125,91	412	310	237	169,19	540	405	310	194,03	
5	230	374	283	218	150,42	515	387	297	204,52	675	506	387	235,57	
6	276	448	339	262	174,93	618	464	356	239,85	810	607	465	277,11	
7	322	523	396	305	199,44	721	542	415	275,18	945	709	542	318,65	
8	368	598	452	349	223,95	824	619	475	310,51	1.080	810	620	360,19	
9	414	672	509	392	248,46	927	697	534	345,84	1.215	911	697	401,73	
10	460	747	565	436	272,97	1.030	774	593	381,17	1.350	1.012	774	443,27	
11	506	822	622	480	297,48	1.133	852	653	416,50	1.485	1.114	852	484,81	
12	552	896	678	523	321,99	1.236	929	712	451,83	1.620	1.215	929	526,35	
13	598	971	735	567	346,50	1.339	1.006	771	487,16	1.755	1.316	1.007	567,89	
14	644	1.046	791	610	371,01	1.442	1.084	831	522,49	1.890	1.417	1.084	609,43	
15	690	1.121	848	654	395,52	1.545	1.161	890	557,82	2.025	1.518	1.162	650,97	
16	736	1.195	904	698	433,96	1.648	1.239	949	607,08	2.160	1.620	1.239	706,44	
17	782	1.270	961	741	458,47	1.751	1.316	1.009	642,41	2.295	1.721	1.317	747,98	
18	828	1.345	1.017	785	482,98	1.854	1.393	1.068	677,74	2.430	1.822	1.394	789,52	
19	874	1.419	1.074	828	507,49	1.957	1.471	1.128	713,07	2.565	1.923	1.471	831,06	
20	920	1.494	1.130	872	532,00	2.060	1.548	1.187	748,40	2.700	2.025	1.549	872,60	
21	966	1.569	1.187	916	556,51	2.163	1.626	1.246	783,73	2.835	2.126	1.626	914,14	
22	1.012	1.643	1.243	959	581,02	2.266	1.703	1.306	819,06	2.970	2.227	1.704	955,68	
23	1.058	1.718	1.300	1.003	605,53	2.369	1.780	1.365	854,39	3.105	2.328	1.781	997,22	
24	1.104	1.793	1.356	1.046	630,04	2.472	1.858	1.424	889,72	3.240	2.430	1.859	1.038,76	
25	1.150	1.868	1.413	1.090	654,55	2.575	1.935	1.484	925,05	3.375	2.531	1.936	1.080,30	
26	1.196	1.942	1.469	1.134	679,06	2.678	2.013	1.543	960,38	3.510	2.632	2.014	1.121,84	
27	1.242	2.017	1.526	1.177	703,57	2.781	2.090	1.602	995,71	3.645	2.733	2.091	1.163,38	
28	1.288	2.092	1.582	1.221	728,08	2.884	2.167	1.662	1.031,04	3.780	2.835	2.168	1.204,92	
29	1.334	2.166	1.639	1.264	752,59	2.987	2.245	1.721	1.066,37	3.915	2.936	2.246	1.246,46	
30	1.380	2.241	1.696	1.308	777,10	3.090	2.322	1.780	1.101,70	4.050	3.037	2.323	1.288,00	
31	1.426	2.316	1.752	1.352	815,53	3.193	2.400	1.840	1.150,95	4.185	3.138	2.401	1.343,46	
32	1.472	2.390	1.809	1.395	840,04	3.296	2.477	1.899	1.186,28	4.320	3.239	2.478	1.385,00	
33	1.518	2.465	1.865	1.439	864,55	3.399	2.555	1.958	1.221,61	4.455	3.341	2.556	1.426,54	
34	1.564	2.540	1.922	1.482	889,06	3.502	2.632	2.018	1.256,94	4.590	3.442	2.633	1.468,08	
35	1.610	2.615	1.978	1.526	913,57	3.605	2.709	2.077	1.292,27	4.725	3.543	2.711	1.509,62	
36	1.656	2.689	2.035	1.570	938,08	3.708	2.787	2.136	1.327,60	4.860	3.644	2.788	1.551,16	
37	1.702	2.764	2.091	1.613	962,59	3.811	2.864	2.196	1.362,93	4.995	3.746	2.865	1.592,70	
38	1.748	2.839	2.148	1.657	987,10	3.914	2.942	2.255	1.398,26	5.130	3.847	2.943	1.634,24	
39	1.794	2.913	2.204	1.700	1.011,61	4.017	3.019	2.314	1.433,59	5.265	3.948	3.020	1.675,78	
40	1.840	2.988	2.261	1.744	1.036,12	4.120	3.096	2.374	1.468,92	5.400	4.049	3.098	1.717,32	

Precios para color blanco estándar RAL 9016.

Precios para carta de colores Zehnder +25%. Otros colores, consultar.





# Zehnder Charleston

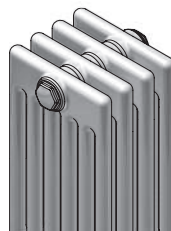
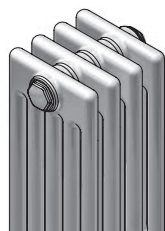
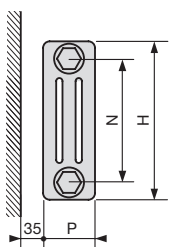

MODELO	5110	6110
Altura H	1.100 mm	1.100 mm
Entre ejes N	1.034 mm	1.034 mm
Profundidad P	173 mm	210 mm
Exponente n	1,31	1,32

Recuerde pedir el Pack de Conexión

Longitud L	Emisión EN 442 75/65/20 ΔT 50K W	Emisión Caldera condens. ΔT 40K W	Emisión Bomba de calor ΔT 32,5K W	Blanco RAL 9016 PVP €	Emisión EN 442 75/65/20 ΔT 50K W	Emisión Caldera condens. ΔT 40K W	Emisión Bomba de calor ΔT 32,5K W	Blanco RAL 9016 PVP €	
4	184	668	499	380	238,19	792	590	449	285,91
5	230	835	623	475	290,77	990	737	561	350,42
6	276	1.002	748	570	343,35	1.188	885	673	414,93
7	322	1.169	873	665	395,93	1.386	1.032	785	479,44
8	368	1.336	997	760	448,51	1.584	1.180	897	543,95
9	414	1.503	1.122	855	501,09	1.782	1.327	1.009	608,46
10	460	1.670	1.247	950	553,67	1.980	1.475	1.121	672,97
11	506	1.837	1.371	1.045	620,18	2.178	1.622	1.233	751,41
12	552	2.004	1.496	1.140	672,76	2.376	1.770	1.346	815,92
13	598	2.171	1.621	1.235	725,34	2.574	1.917	1.458	880,43
14	644	2.338	1.745	1.330	777,92	2.772	2.065	1.570	944,94
15	690	2.505	1.870	1.425	830,50	2.970	2.212	1.682	1.009,45
16	736	2.672	1.995	1.520	883,08	3.168	2.360	1.794	1.073,96
17	782	2.839	2.119	1.615	935,66	3.366	2.507	1.906	1.138,47
18	828	3.006	2.244	1.710	988,24	3.564	2.655	2.018	1.202,98
19	874	3.173	2.369	1.805	1.040,82	3.762	2.802	2.130	1.267,49
20	920	3.340	2.493	1.900	1.093,40	3.960	2.950	2.243	1.332,00
21	966	3.507	2.618	1.995	1.159,90	4.158	3.097	2.355	1.410,43
22	1.012	3.674	2.743	2.090	1.212,48	4.356	3.245	2.467	1.474,94
23	1.058	3.841	2.867	2.185	1.265,06	4.554	3.392	2.579	1.539,45
24	1.104	4.008	2.992	2.280	1.317,64	4.752	3.540	2.691	1.603,96
25	1.150	4.175	3.117	2.375	1.370,22	4.950	3.687	2.803	1.668,47
26	1.196	4.342	3.241	2.469	1.422,80	5.148	3.835	2.915	1.732,98
27	1.242	4.509	3.366	2.564	1.475,38	5.346	3.982	3.027	1.797,49
28	1.288	4.676	3.491	2.659	1.527,96	5.544	4.130	3.140	1.862,00
29	1.334	4.843	3.615	2.754	1.580,54	5.742	4.277	3.252	1.926,51
30	1.380	5.010	3.740	2.849	1.633,12	5.940	4.425	3.364	1.991,02
31	1.426	5.177	3.865	2.944	1.698,83	6.138	4.572	3.476	2.068,66
32	1.472	5.344	3.989	3.039	1.751,41	6.336	4.719	3.588	2.133,17
33	1.518	5.511	4.114	3.134	1.803,99	6.534	4.867	3.700	2.197,68
34	1.564	5.678	4.239	3.229	1.856,57	6.732	5.014	3.812	2.262,19
35	1.610	5.845	4.363	3.324	1.909,15	6.930	5.162	3.924	2.326,70
36	1.656	6.012	4.488	3.419	1.961,73	7.128	5.309	4.037	2.391,21
37	1.702	6.179	4.613	3.514	2.014,31	7.326	5.457	4.149	2.455,72
38	1.748	6.346	4.737	3.609	2.066,89	7.524	5.604	4.261	2.520,23
39	1.794	6.513	4.862	3.704	2.119,47	7.722	5.752	4.373	2.584,74
40	1.840	6.680	4.987	3.799	2.172,05	7.920	5.899	4.485	2.649,25

Precios para color blanco estándar RAL 9016.

Precios para carta de colores Zehnder +25%. Otros colores, consultar.



# Zehnder Charleston

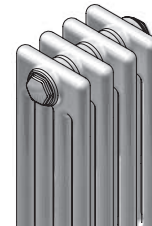
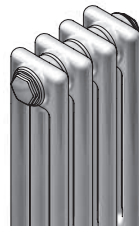
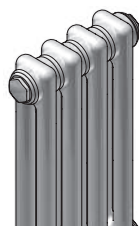
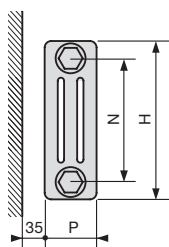

MODELO	2120	3120	4120
Altura H	1.200 mm	1.200 mm	1.200 mm
Entre ejes N	1.134 mm	1.134 mm	1.134 mm
Profundidad P	62 mm	100 mm	136 mm
Exponente n	1,26	1,29	1,30

Recuerde pedir el Pack de Conexión

Longitud L	Elem.	mm	Emisión	Emisión	Emisión	Blanco	Emisión	Emisión	Emisión	Blanco	Emisión	Emisión	Emisión	Blanco
			EN 442 75/65/20 ΔT 50K W	Caldera condens. ΔT 40K W	Bomba de calor ΔT 32,5K W	RAL 9016 PVP €	EN 442 75/65/20 ΔT 50K W	Caldera condens. ΔT 40K W	Bomba de calor ΔT 32,5K W	RAL 9016 PVP €	EN 442 75/65/20 ΔT 50K W	Caldera condens. ΔT 40K W	Bomba de calor ΔT 32,5K W	RAL 9016 PVP €
4	184	331	250	192	139,91	460	345	264	198,79	588	440	336	236,83	
5	230	414	312	240	167,92	575	431	330	241,52	735	550	420	289,07	
6	276	496	375	288	195,93	690	517	396	284,25	882	660	504	341,31	
7	322	579	437	336	223,94	805	604	462	326,98	1.029	770	588	393,55	
8	368	662	499	384	251,95	920	690	528	369,71	1.176	880	672	445,79	
9	414	744	562	433	279,96	1.035	776	594	412,44	1.323	990	756	498,03	
10	460	827	624	481	307,97	1.150	862	660	455,17	1.470	1.100	840	550,27	
11	506	910	687	529	335,98	1.265	949	726	497,90	1.617	1.210	924	602,51	
12	552	992	749	577	363,99	1.380	1.035	792	540,63	1.764	1.320	1.008	654,75	
13	598	1.075	812	625	392,00	1.495	1.121	858	583,36	1.911	1.430	1.092	706,99	
14	644	1.158	874	673	420,01	1.610	1.207	924	626,09	2.058	1.540	1.176	759,23	
15	690	1.241	936	721	448,02	1.725	1.294	990	668,82	2.205	1.650	1.259	811,47	
16	736	1.323	999	769	489,96	1.840	1.380	1.056	725,48	2.352	1.760	1.343	877,64	
17	782	1.406	1.061	817	517,97	1.955	1.466	1.122	768,21	2.499	1.870	1.427	929,88	
18	828	1.489	1.124	865	545,98	2.070	1.552	1.187	810,94	2.646	1.980	1.511	982,12	
19	874	1.571	1.186	913	573,99	2.185	1.638	1.253	853,67	2.793	2.090	1.595	1.034,36	
20	920	1.654	1.249	961	602,00	2.300	1.725	1.319	896,40	2.940	2.200	1.679	1.086,60	
21	966	1.737	1.311	1.009	630,01	2.415	1.811	1.385	939,13	3.087	2.310	1.763	1.138,84	
22	1.012	1.819	1.373	1.057	658,02	2.530	1.897	1.451	981,86	3.234	2.420	1.847	1.191,08	
23	1.058	1.902	1.436	1.105	686,03	2.645	1.983	1.517	1.024,59	3.381	2.530	1.931	1.243,32	
24	1.104	1.985	1.498	1.153	714,04	2.760	2.070	1.583	1.067,32	3.528	2.640	2.015	1.295,56	
25	1.150	2.068	1.561	1.201	742,05	2.875	2.156	1.649	1.110,05	3.675	2.750	2.099	1.347,80	
26	1.196	2.150	1.623	1.250	770,06	2.990	2.242	1.715	1.152,78	3.822	2.860	2.183	1.400,04	
27	1.242	2.233	1.686	1.298	798,07	3.105	2.328	1.781	1.195,51	3.969	2.970	2.267	1.452,28	
28	1.288	2.316	1.748	1.346	826,08	3.220	2.415	1.847	1.238,24	4.116	3.080	2.351	1.504,52	
29	1.334	2.398	1.810	1.394	854,09	3.335	2.501	1.913	1.280,97	4.263	3.190	2.435	1.556,76	
30	1.380	2.481	1.873	1.442	882,10	3.450	2.587	1.979	1.323,70	4.410	3.300	2.519	1.609,00	
31	1.426	2.564	1.935	1.490	924,03	3.565	2.673	2.045	1.380,35	4.557	3.410	2.603	1.675,16	
32	1.472	2.646	1.998	1.538	952,04	3.680	2.760	2.111	1.423,08	4.704	3.520	2.687	1.727,40	
33	1.518	2.729	2.060	1.586	980,05	3.795	2.846	2.177	1.465,81	4.851	3.630	2.771	1.779,64	
34	1.564	2.812	2.123	1.634	1.008,06	3.910	2.932	2.243	1.508,54	4.998	3.739	2.855	1.831,88	
35	1.610	2.895	2.185	1.682	1.036,07	4.025	3.018	2.309	1.551,27	5.145	3.849	2.939	1.884,12	
36	1.656	2.977	2.248	1.730	1.064,08	4.140	3.104	2.375	1.594,00	5.292	3.959	3.023	1.936,36	
37	1.702	3.060	2.310	1.778	1.092,09	4.255	3.191	2.441	1.636,73	5.439	4.069	3.107	1.988,60	
38	1.748	3.143	2.372	1.826	1.120,10	4.370	3.277	2.507	1.679,46	5.586	4.179	3.191	2.040,84	
39	1.794	3.225	2.435	1.874	1.148,11	4.485	3.363	2.573	1.722,19	5.733	4.289	3.275	2.093,08	
40	1.840	3.308	2.497	1.922	1.176,12	4.600	3.449	2.639	1.764,92	5.880	4.399	3.359	2.145,32	

Precios para color blanco estándar RAL 9016.

Precios para carta de colores Zehnder +25%. Otros colores, consultar.



# Zehnder Charleston

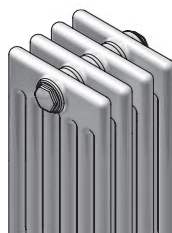
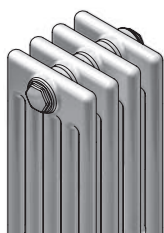
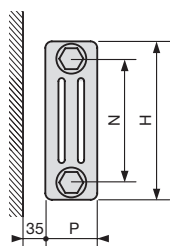

MODELO	5120	6120
Altura H	1.200 mm	1.200 mm
Entre ejes N	1.134 mm	1.134 mm
Profundidad P	173 mm	210 mm
Exponente n	1,31	1,32

Recuerde pedir el Pack de Conexión

Longitud L	Emisión EN 442 75/65/20 ΔT 50K W	Emisión Caldera condens. ΔT 40K W	Emisión Bomba de calor ΔT 32,5K W	Blanco RAL 9016 PVP €	Emisión EN 442 75/65/20 ΔT 50K W	Emisión Caldera condens. ΔT 40K W	Emisión Bomba de calor ΔT 32,5K W	Blanco RAL 9016 PVP €	
4	184	716	535	407	291,67	840	626	476	330,75
5	230	895	668	509	357,62	1.050	782	595	406,47
6	276	1.074	802	611	423,57	1.260	939	714	482,19
7	322	1.253	935	713	489,52	1.470	1.095	832	557,91
8	368	1.432	1.069	814	555,47	1.680	1.251	951	633,63
9	414	1.611	1.203	916	621,42	1.890	1.408	1.070	709,35
10	460	1.790	1.336	1.018	687,37	2.100	1.564	1.189	785,07
11	506	1.969	1.470	1.120	767,25	2.310	1.721	1.308	874,72
12	552	2.148	1.604	1.222	833,20	2.520	1.877	1.427	950,44
13	598	2.327	1.737	1.323	899,15	2.730	2.033	1.546	1.026,16
14	644	2.506	1.871	1.425	965,10	2.940	2.190	1.665	1.101,88
15	690	2.685	2.004	1.527	1.031,05	3.150	2.346	1.784	1.177,60
16	736	2.864	2.138	1.629	1.097,00	3.360	2.503	1.903	1.253,32
17	782	3.043	2.272	1.731	1.162,95	3.570	2.659	2.022	1.329,04
18	828	3.222	2.405	1.832	1.228,90	3.780	2.816	2.141	1.404,76
19	874	3.401	2.539	1.934	1.294,85	3.990	2.972	2.260	1.480,48
20	920	3.580	2.673	2.036	1.360,80	4.200	3.128	2.378	1.556,20
21	966	3.759	2.806	2.138	1.440,67	4.410	3.285	2.497	1.645,84
22	1.012	3.938	2.940	2.240	1.506,62	4.620	3.441	2.616	1.721,56
23	1.058	4.117	3.073	2.342	1.572,57	4.830	3.598	2.735	1.797,28
24	1.104	4.296	3.207	2.443	1.638,52	5.040	3.754	2.854	1.873,00
25	1.150	4.475	3.341	2.545	1.704,47	5.250	3.911	2.973	1.948,72
26	1.196	4.654	3.474	2.647	1.770,42	5.460	4.067	3.092	2.024,44
27	1.242	4.833	3.608	2.749	1.836,37	5.670	4.223	3.211	2.100,16
28	1.288	5.012	3.742	2.851	1.902,32	5.880	4.380	3.330	2.175,88
29	1.334	5.191	3.875	2.952	1.968,27	6.090	4.536	3.449	2.251,60
30	1.380	5.370	4.009	3.054	2.034,22	6.300	4.693	3.568	2.327,32
31	1.426	5.549	4.143	3.156	2.113,30	6.510	4.849	3.687	2.416,17
32	1.472	5.728	4.276	3.258	2.179,25	6.720	5.006	3.806	2.491,89
33	1.518	5.907	4.410	3.360	2.245,20	6.930	5.162	3.924	2.567,61
34	1.564	6.086	4.543	3.461	2.311,15	7.140	5.318	4.043	2.643,33
35	1.610	6.265	4.677	3.563	2.377,10	7.350	5.475	4.162	2.719,05
36	1.656	6.444	4.811	3.665	2.443,05	7.560	5.631	4.281	2.794,77
37	1.702	6.623	4.944	3.767	2.509,00	7.770	5.788	4.400	2.870,49
38	1.748	6.802	5.078	3.869	2.574,95	7.980	5.944	4.519	2.946,21
39	1.794	6.981	5.212	3.970	2.640,90	8.190	6.100	4.638	3.021,93
40	1.840	7.160	5.345	4.072	2.706,85	8.400	6.257	4.757	3.097,65

Precios para color blanco estándar RAL 9016.

Precios para carta de colores Zehnder +25%. Otros colores, consultar.



# Zehnder Charleston

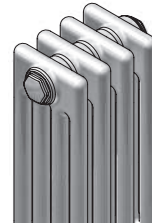
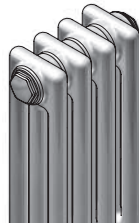
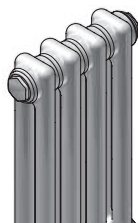
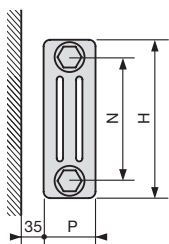

MODELO	2150	3150	4150
Altura H	1.500 mm	1.500 mm	1.500 mm
Entre ejes N	1.434 mm	1.434 mm	1.434 mm
Profundidad P	62 mm	100 mm	136 mm
Exponente n	1,28	1,31	1,31

Recuerde pedir el Pack de Conexión

Longitud L	Elem.	mm	Emisión	Emisión	Emisión	Blanco	Emisión	Emisión	Emisión	Blanco	Emisión	Emisión	Emisión	Blanco
			EN 442 75/65/20 ΔT 50K W	Caldera condens. ΔT 40K W	Bomba de calor ΔT 32,5K W	RAL 9016 PVP €	EN 442 75/65/20 ΔT 50K W	Caldera condens. ΔT 40K W	Bomba de calor ΔT 32,5K W	RAL 9016 PVP €	EN 442 75/65/20 ΔT 50K W	Caldera condens. ΔT 40K W	Bomba de calor ΔT 32,5K W	RAL 9016 PVP €
4	184	416	313	240	170,31	560	418	318	228,11	720	654	498	266,95	
5	230	520	391	300	205,92	700	523	398	278,17	900	817	623	326,72	
6	276	624	469	360	241,53	840	627	478	328,23	1.080	981	747	386,49	
7	322	728	547	419	277,14	980	732	557	378,29	1.260	1.144	872	446,26	
8	368	832	625	479	312,75	1.120	836	637	428,35	1.440	1.308	996	506,03	
9	414	936	703	539	348,36	1.260	941	717	478,41	1.620	1.471	1.121	565,80	
10	460	1.040	782	599	383,97	1.400	1.045	796	528,47	1.800	1.635	1.246	625,57	
11	506	1.144	860	659	419,58	1.540	1.150	876	578,53	1.980	1.798	1.370	685,34	
12	552	1.248	938	719	469,12	1.680	1.254	955	642,52	2.160	1.962	1.495	759,04	
13	598	1.352	1.016	779	504,73	1.820	1.359	1.035	692,58	2.340	2.125	1.619	818,81	
14	644	1.456	1.094	839	540,34	1.960	1.463	1.115	742,64	2.520	2.289	1.744	878,58	
15	690	1.560	1.172	899	575,95	2.100	1.568	1.194	792,70	2.700	2.452	1.868	938,35	
16	736	1.664	1.251	959	611,56	2.240	1.672	1.274	842,76	2.880	2.616	1.993	998,12	
17	782	1.768	1.329	1.019	647,17	2.380	1.777	1.354	892,82	3.060	2.779	2.117	1.057,89	
18	828	1.872	1.407	1.079	682,78	2.520	1.881	1.433	942,88	3.240	2.943	2.242	1.117,66	
19	874	1.976	1.485	1.138	718,39	2.660	1.986	1.513	992,94	3.420	3.106	2.367	1.177,43	
20	920	2.080	1.563	1.198	754,00	2.800	2.090	1.592	1.043,00	3.600	3.270	2.491	1.237,20	
21	966	2.184	1.641	1.258	789,61	2.940	2.195	1.672	1.093,06	3.780	3.433	2.616	1.296,97	
22	1.012	2.288	1.720	1.318	839,14	3.080	2.299	1.752	1.157,04	3.960	3.597	2.740	1.370,66	
23	1.058	2.392	1.798	1.378	874,75	3.220	2.404	1.831	1.193,18	4.140	3.760	2.865	1.430,43	
24	1.104	2.496	1.876	1.438	910,36	3.360	2.508	1.911	1.243,24	4.320	3.924	2.989	1.490,20	
25	1.150	2.600	1.954	1.498	945,97	3.500	2.613	1.991	1.293,30	4.500	4.087	3.114	1.549,97	
26	1.196	2.704	2.032	1.558	981,58	3.640	2.717	2.070	1.343,36	4.680	4.251	3.238	1.609,74	
27	1.242	2.808	2.110	1.618	1.017,19	3.780	2.822	2.150	1.393,42	4.860	4.414	3.363	1.669,51	
28	1.288	2.912	2.189	1.678	1.052,80	3.920	2.926	2.229	1.443,48	5.040	4.578	3.488	1.729,28	
29	1.334	3.016	2.267	1.738	1.088,41	4.060	3.031	2.309	1.493,54	5.220	4.741	3.612	1.789,05	
30	1.380	3.120	2.345	1.798	1.124,02	4.200	3.135	2.389	1.543,60	5.400	4.905	3.737	1.848,82	
31	1.426	3.224	2.423	1.857	1.159,63	4.340	3.240	2.468	1.607,58	5.580	5.068	3.861	1.908,59	
32	1.472	3.328	2.501	1.917	1.208,37	4.480	3.344	2.548	1.670,77	5.760	5.232	3.986	1.981,49	
33	1.518	3.432	2.579	1.977	1.243,98	4.620	3.449	2.628	1.720,83	5.940	5.395	4.110	2.041,26	
34	1.564	3.536	2.657	2.037	1.279,59	4.760	3.553	2.707	1.770,89	6.120	5.559	4.235	2.101,03	
35	1.610	3.640	2.736	2.097	1.315,20	4.900	3.658	2.787	1.820,95	6.300	5.722	4.359	2.160,80	
36	1.656	3.744	2.814	2.157	1.350,81	5.040	3.763	2.866	1.871,01	6.480	5.886	4.484	2.220,57	
37	1.702	3.848	2.892	2.217	1.386,42	5.180	3.867	2.946	1.921,07	6.660	6.049	4.609	2.280,34	
38	1.748	3.952	2.970	2.277	1.422,03	5.320	3.972	3.026	1.971,13	6.840	6.213	4.733	2.340,11	
39	1.794	4.056	3.048	2.337	1.457,64	5.460	4.076	3.105	2.021,19	7.020	6.376	4.858	2.399,88	
40	1.840	4.160	3.126	2.397	1.493,25	5.600	4.181	3.185	2.071,25	7.200	6.540	4.982	2.459,65	

Precios para color blanco estándar RAL 9016.

Precios para carta de colores Zehnder +25%. Otros colores, consultar.



# Zehnder Charleston

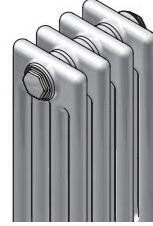
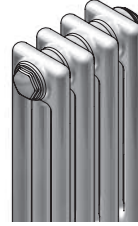
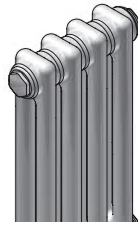
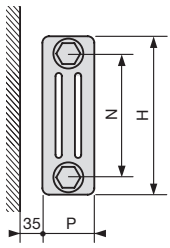

MODELO	2180	3180	4180
Altura H	1.800 mm	1.800 mm	1.800 mm
Entre ejes N	1.734 mm	1.734 mm	1.734 mm
Profundidad P	62 mm	100 mm	136 mm
Exponente n	1,31	1,33	1,33

Recuerde pedir el Pack de Conexión

Longitud L	Elem.	mm	Emisión	Emisión	Emisión	Blanco	Emisión	Emisión	Emisión	Blanco	Emisión	Emisión	Emisión	Blanco
			EN 442 75/65/20 ΔT 50K W	Caldera condens. ΔT 40K W	Bomba de calor ΔT 32,5K W	RAL 9016 PVP €	EN 442 75/65/20 ΔT 50K W	Caldera condens. ΔT 40K W	Bomba de calor ΔT 32,5K W	RAL 9016 PVP €	EN 442 75/65/20 ΔT 50K W	Caldera condens. ΔT 40K W	Bomba de calor ΔT 32,5K W	RAL 9016 PVP €
4	184	496	370	282	200,31	664	493	374	261,03	852	633	480	312,95	
5	230	620	463	353	243,42	830	617	468	319,32	1.065	792	601	384,22	
6	276	744	555	423	286,53	996	740	562	377,61	1.278	950	721	455,49	
7	322	868	648	494	329,64	1.162	864	655	435,90	1.491	1.108	841	526,76	
8	368	992	741	564	372,75	1.328	987	749	494,19	1.704	1.266	961	598,03	
9	414	1.116	833	635	415,86	1.494	1.110	842	552,48	1.917	1.425	1.081	669,30	
10	460	1.240	926	705	458,97	1.660	1.234	936	610,77	2.130	1.583	1.201	740,57	
11	506	1.364	1.018	776	502,08	1.826	1.357	1.030	669,06	2.343	1.741	1.321	811,84	
12	552	1.488	1.111	846	559,12	1.992	1.480	1.123	741,28	2.556	1.900	1.441	897,04	
13	598	1.612	1.203	917	602,23	2.158	1.604	1.217	799,57	2.769	2.058	1.561	968,31	
14	644	1.736	1.296	987	645,34	2.324	1.727	1.310	857,86	2.982	2.216	1.681	1.039,58	
15	690	1.860	1.389	1.058	688,45	2.490	1.851	1.404	916,15	3.195	2.375	1.802	1.110,85	
16	736	1.984	1.481	1.128	731,56	2.656	1.974	1.498	974,44	3.408	2.533	1.922	1.182,12	
17	782	2.108	1.574	1.199	774,67	2.822	2.097	1.591	1.032,73	3.621	2.691	2.042	1.253,39	
18	828	2.232	1.666	1.269	817,78	2.988	2.221	1.685	1.091,02	3.834	2.849	2.162	1.324,66	
19	874	2.356	1.759	1.340	860,89	3.154	2.344	1.778	1.149,31	4.047	3.008	2.282	1.395,93	
20	920	2.480	1.851	1.410	904,00	3.320	2.467	1.872	1.207,60	4.260	3.166	2.402	1.467,20	
21	966	2.604	1.944	1.481	947,11	3.486	2.591	1.966	1.265,89	4.473	3.324	2.522	1.538,47	
22	1.012	2.728	2.037	1.552	1.004,14	3.652	2.714	2.059	1.338,10	4.686	3.483	2.642	1.623,66	
23	1.058	2.852	2.129	1.622	1.047,25	3.818	2.838	2.153	1.396,39	4.899	3.641	2.762	1.694,93	
24	1.104	2.976	2.222	1.693	1.090,36	3.984	2.961	2.246	1.454,68	5.112	3.799	2.882	1.766,20	
25	1.150	3.100	2.314	1.763	1.133,47	4.150	3.084	2.340	1.512,97	5.325	3.958	3.003	1.837,47	
26	1.196	3.224	2.407	1.834	1.176,58	4.316	3.208	2.434	1.571,26	5.538	4.116	3.123	1.908,74	
27	1.242	3.348	2.499	1.904	1.219,69	4.482	3.331	2.527	1.629,55	5.751	4.274	3.243	1.980,01	
28	1.288	3.472	2.592	1.975	1.262,80	4.648	3.454	2.621	1.687,84	5.964	4.432	3.363	2.051,28	
29	1.334	3.596	2.685	2.045	1.305,91	4.814	3.578	2.714	1.746,13	6.177	4.591	3.483	2.122,55	
30	1.380	3.720	2.777	2.116	1.349,02	4.980	3.701	2.808	1.804,42	6.390	4.749	3.603	2.193,82	
31	1.426	3.844	2.870	2.186	1.392,13	5.146	3.825	2.902	1.862,71	6.603	4.907	3.723	2.265,09	
32	1.472	3.968	2.962	2.257	1.448,37	5.312	3.948	2.995	1.934,13	6.816	5.066	3.843	2.349,49	
33	1.518	4.092	3.055	2.327	1.491,48	5.478	4.071	3.089	1.992,42	7.029	5.224	3.963	2.420,76	
34	1.564	4.216	3.147	2.398	1.534,59	5.644	4.195	3.182	2.050,71	7.242	5.382	4.084	2.492,03	
35	1.610	4.340	3.240	2.468	1.577,70	5.810	4.318	3.276	2.109,00	7.455	5.541	4.204	2.563,30	
36	1.656	4.464	3.333	2.539	1.620,81	5.976	4.441	3.370	2.167,29	7.668	5.699	4.324	2.634,57	
37	1.702	4.588	3.425	2.609	1.663,92	6.142	4.565	3.463	2.225,58	7.881	5.857	4.444	2.705,84	
38	1.748	4.712	3.518	2.680	1.707,03	6.308	4.688	3.557	2.283,87	8.094	6.016	4.564	2.777,11	
39	1.794	4.836	3.610	2.750	1.750,14	6.474	4.812	3.650	2.342,16	8.307	6.174	4.684	2.848,38	
40	1.840	4.960	3.703	2.821	1.793,25	6.640	4.935	3.744	2.400,45	8.520	6.332	4.804	2.919,65	

Precios para color blanco estándar RAL 9016.

Precios para carta de colores Zehnder +25%. Otros colores, consultar.



# Zehnder Charleston

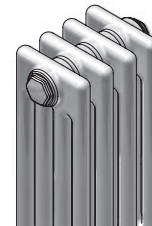
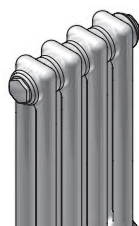
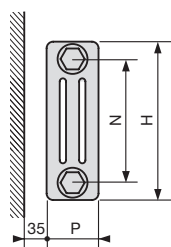

MODELO	2200	3200	4200
Altura H	2.000 mm	2.000 mm	2.000 mm
Entre ejes N	1.934 mm	1.934 mm	1.934 mm
Profundidad P	62 mm	100 mm	136 mm
Exponente n	1,31	1,33	1,32

Recuerde pedir el Pack de Conexión

Longitud L	Elem.	mm	Emisión	Emisión	Emisión	Blanco	Emisión	Emisión	Emisión	Blanco	Emisión	Emisión	Emisión	Blanco
			EN 442 75/65/20 ΔT 50K W	Caldera condens. ΔT 40K W	Bomba de calor ΔT 32,5K W	RAL 9016 PVP €	EN 442 75/65/20 ΔT 50K W	Caldera condens. ΔT 40K W	Bomba de calor ΔT 32,5K W	RAL 9016 PVP €	EN 442 75/65/20 ΔT 50K W	Caldera condens. ΔT 40K W	Bomba de calor ΔT 32,5K W	RAL 9016 PVP €
4	184	552	412	314	218,67	732	544	413	286,59	936	697	530	342,95	
5	230	690	515	392	266,37	915	680	516	351,27	1.170	871	663	421,72	
6	276	828	618	471	314,07	1.098	816	619	415,95	1.404	1.046	795	500,49	
7	322	966	721	549	361,77	1.281	952	722	480,63	1.638	1.220	928	579,26	
8	368	1.104	824	628	409,47	1.464	1.088	825	545,31	1.872	1.394	1.060	658,03	
9	414	1.242	927	706	457,17	1.647	1.224	929	609,99	2.106	1.569	1.193	736,80	
10	460	1.380	1.030	785	504,87	1.830	1.360	1.032	674,67	2.340	1.743	1.325	815,57	
11	506	1.518	1.133	863	552,57	2.013	1.496	1.135	739,35	2.574	1.917	1.458	894,34	
12	552	1.656	1.236	942	614,20	2.196	1.632	1.238	817,96	2.808	2.092	1.590	987,04	
13	598	1.794	1.339	1.020	661,90	2.379	1.768	1.341	882,64	3.042	2.266	1.723	1.065,81	
14	644	1.932	1.442	1.099	709,60	2.562	1.904	1.445	947,32	3.276	2.440	1.855	1.144,58	
15	690	2.070	1.545	1.177	757,30	2.745	2.040	1.548	1.012,00	3.510	2.614	1.988	1.223,35	
16	736	2.208	1.648	1.256	805,00	2.928	2.176	1.651	1.076,68	3.744	2.789	2.120	1.302,12	
17	782	2.346	1.751	1.334	852,70	3.111	2.312	1.754	1.141,36	3.978	2.963	2.253	1.380,89	
18	828	2.484	1.854	1.413	900,40	3.294	2.448	1.857	1.206,04	4.212	3.137	2.385	1.459,66	
19	874	2.622	1.957	1.491	948,10	3.477	2.584	1.961	1.270,72	4.446	3.312	2.518	1.538,43	
20	920	2.760	2.060	1.570	995,80	3.660	2.720	2.064	1.335,40	4.680	3.486	2.650	1.617,20	
21	966	2.898	2.163	1.648	1.043,50	3.843	2.856	2.167	1.400,08	4.914	3.660	2.783	1.695,97	
22	1.012	3.036	2.266	1.727	1.105,12	4.026	2.992	2.270	1.478,68	5.148	3.835	2.915	1.788,66	
23	1.058	3.174	2.369	1.805	1.152,82	4.209	3.128	2.373	1.543,36	5.382	4.009	3.048	1.867,43	
24	1.104	3.312	2.473	1.884	1.200,52	4.392	3.264	2.476	1.608,04	5.616	4.183	3.180	1.946,20	
25	1.150	3.450	2.576	1.962	1.248,22	4.575	3.400	2.580	1.672,72	5.850	4.357	3.313	2.024,97	
26	1.196	3.588	2.679	2.041	1.295,92	4.758	3.536	2.683	1.737,40	6.084	4.532	3.445	2.103,74	
27	1.242	3.726	2.782	2.119	1.343,62	4.941	3.672	2.786	1.802,08	6.318	4.706	3.578	2.182,51	
28	1.288	3.864	2.885	2.198	1.391,32	5.124	3.808	2.889	1.866,76	6.552	4.880	3.710	2.261,28	
29	1.334	4.002	2.988	2.276	1.439,02	5.307	3.944	2.992	1.931,44	6.786	5.055	3.843	2.340,05	
30	1.380	4.140	3.091	2.355	1.486,72	5.490	4.080	3.096	1.996,12	7.020	5.229	3.975	2.418,82	
31	1.426	4.278	3.194	2.433	1.534,42	5.673	4.216	3.199	2.060,80	7.254	5.403	4.108	2.497,59	
32	1.472	4.416	3.297	2.512	1.595,25	5.856	4.352	3.302	2.138,61	7.488	5.578	4.240	2.589,49	
33	1.518	4.554	3.400	2.590	1.642,95	6.039	4.488	3.405	2.203,29	7.722	5.752	4.373	2.668,26	
34	1.564	4.692	3.503	2.669	1.690,65	6.222	4.624	3.508	2.267,97	7.956	5.926	4.505	2.747,03	
35	1.610	4.830	3.606	2.747	1.738,35	6.405	4.760	3.612	2.332,65	8.190	6.100	4.638	2.825,80	
36	1.656	4.968	3.709	2.826	1.786,05	6.588	4.896	3.715	2.397,33	8.424	6.275	4.771	2.904,57	
37	1.702	5.106	3.812	2.904	1.833,75	6.771	5.032	3.818	2.462,01	8.658	6.449	4.903	2.983,34	
38	1.748	5.244	3.915	2.982	1.881,45	6.954	5.168	3.921	2.526,69	8.892	6.623	5.036	3.062,11	
39	1.794	5.382	4.018	3.061	1.929,15	7.137	5.304	4.024	2.591,37	9.126	6.798	5.168	3.140,88	
40	1.840	5.520	4.121	3.139	1.976,85	7.320	5.440	4.127	2.656,05	9.360	6.972	5.301	3.219,65	

Precios para color blanco estándar RAL 9016.

Precios para carta de colores Zehnder +25%. Otros colores, consultar.



# Zehnder Charleston

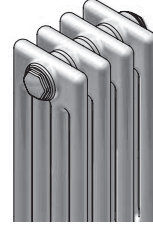
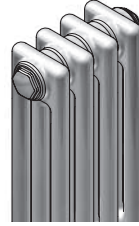
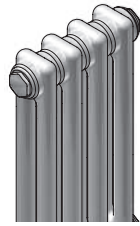
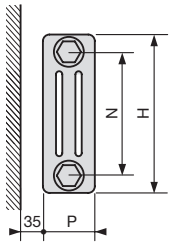

MODELO	2220	3220	4220
Altura H	2.200 mm	2.200 mm	2.200 mm
Entre ejes N	2.134 mm	2.134 mm	2.134 mm
Profundidad P	62 mm	100 mm	136 mm
Exponente n	1,31	1,32	1,32

Recuerde pedir el Pack de Conexión

Longitud L	Elem.	mm	Emisión	Emisión	Emisión	Blanco	Emisión	Emisión	Emisión	Blanco	Emisión	Emisión	Emisión	Blanco
			EN 442 75/65/20 ΔT 50K W	Caldera condens. ΔT 40K W	Bomba de calor ΔT 32,5K W	RAL 9016 PVP €	EN 442 75/65/20 ΔT 50K W	Caldera condens. ΔT 40K W	Bomba de calor ΔT 32,5K W	RAL 9016 PVP €	EN 442 75/65/20 ΔT 50K W	Caldera condens. ΔT 40K W	Bomba de calor ΔT 32,5K W	RAL 9016 PVP €
4	184	604	451	344	232,79	800	596	453	311,11	1.024	763	580	371,07	
5	230	755	564	429	284,02	1.000	745	566	381,92	1.280	953	725	456,87	
6	276	906	676	515	335,25	1.200	894	680	452,73	1.536	1.144	870	542,67	
7	322	1.057	789	601	386,48	1.400	1.043	793	523,54	1.792	1.335	1.015	628,47	
8	368	1.208	902	687	437,71	1.600	1.192	906	594,35	2.048	1.525	1.160	714,27	
9	414	1.359	1.015	773	488,94	1.800	1.341	1.019	665,16	2.304	1.716	1.305	800,07	
10	460	1.510	1.127	859	540,17	2.000	1.490	1.133	735,97	2.560	1.907	1.450	885,87	
11	506	1.661	1.240	945	591,40	2.200	1.639	1.246	806,78	2.816	2.098	1.595	971,67	
12	552	1.812	1.353	1.031	656,56	2.400	1.788	1.359	891,52	3.072	2.288	1.740	1.071,40	
13	598	1.963	1.465	1.116	707,79	2.600	1.937	1.472	962,33	3.328	2.479	1.885	1.157,20	
14	644	2.114	1.578	1.202	759,02	2.800	2.086	1.586	1.033,14	3.584	2.670	2.030	1.243,00	
15	690	2.265	1.691	1.288	810,25	3.000	2.235	1.699	1.103,95	3.840	2.860	2.175	1.328,80	
16	736	2.416	1.804	1.374	861,48	3.200	2.384	1.812	1.174,76	4.096	3.051	2.320	1.414,60	
17	782	2.567	1.916	1.460	912,71	3.400	2.533	1.925	1.245,57	4.352	3.242	2.465	1.500,40	
18	828	2.718	2.029	1.546	963,94	3.600	2.682	2.039	1.316,38	4.608	3.432	2.610	1.586,20	
19	874	2.869	2.142	1.632	1.015,17	3.800	2.830	2.152	1.387,19	4.864	3.623	2.754	1.672,00	
20	920	3.020	2.255	1.718	1.066,40	4.000	2.979	2.265	1.458,00	5.120	3.814	2.899	1.757,80	
21	966	3.171	2.367	1.803	1.117,63	4.200	3.128	2.378	1.528,81	5.376	4.004	3.044	1.843,60	
22	1.012	3.322	2.480	1.889	1.182,78	4.400	3.277	2.492	1.613,54	5.632	4.195	3.189	1.943,32	
23	1.058	3.473	2.593	1.975	1.234,01	4.600	3.426	2.605	1.684,35	5.888	4.386	3.334	2.029,12	
24	1.104	3.624	2.705	2.061	1.285,24	4.800	3.575	2.718	1.755,16	6.144	4.576	3.479	2.114,92	
25	1.150	3.775	2.818	2.147	1.336,47	5.000	3.724	2.831	1.825,97	6.400	4.767	3.624	2.200,72	
26	1.196	3.926	2.931	2.233	1.387,70	5.200	3.873	2.945	1.896,78	6.656	4.958	3.769	2.286,52	
27	1.242	4.077	3.044	2.319	1.438,93	5.400	4.022	3.058	1.967,59	6.912	5.149	3.914	2.372,32	
28	1.288	4.228	3.156	2.405	1.490,16	5.600	4.171	3.171	2.038,40	7.168	5.339	4.059	2.458,12	
29	1.334	4.379	3.269	2.491	1.541,39	5.800	4.320	3.285	2.109,21	7.424	5.530	4.204	2.543,92	
30	1.380	4.530	3.382	2.576	1.592,62	6.000	4.469	3.398	2.180,02	7.680	5.721	4.349	2.629,72	
31	1.426	4.681	3.495	2.662	1.643,85	6.200	4.618	3.511	2.250,83	7.936	5.911	4.494	2.715,52	
32	1.472	4.832	3.607	2.748	1.708,21	6.400	4.767	3.624	2.334,77	8.192	6.102	4.639	2.814,45	
33	1.518	4.983	3.720	2.834	1.759,44	6.600	4.916	3.738	2.405,58	8.448	6.293	4.784	2.900,25	
34	1.564	5.134	3.833	2.920	1.810,67	6.800	5.065	3.851	2.476,39	8.704	6.483	4.929	2.986,05	
35	1.610	5.285	3.945	3.006	1.861,90	7.000	5.214	3.964	2.547,20	8.960	6.674	5.074	3.071,85	
36	1.656	5.436	4.058	3.092	1.913,13	7.200	5.363	4.077	2.618,01	9.216	6.865	5.219	3.157,65	
37	1.702	5.587	4.171	3.178	1.964,36	7.400	5.512	4.191	2.688,82	9.472	7.055	5.364	3.243,45	
38	1.748	5.738	4.284	3.263	2.015,59	7.600	5.661	4.304	2.759,63	9.728	7.246	5.509	3.329,25	
39	1.794	5.889	4.396	3.349	2.066,82	7.800	5.810	4.417	2.830,44	9.984	7.437	5.654	3.415,05	
40	1.840	6.040	4.509	3.435	2.118,05	8.000	5.959	4.530	2.901,25	10.240	7.627	5.799	3.500,85	

Precios para color blanco estándar RAL 9016.

Precios para carta de colores Zehnder +25%. Otros colores, consultar.



# Zehnder Charleston

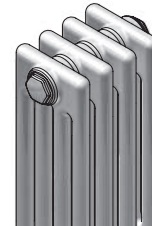
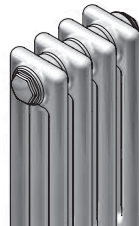
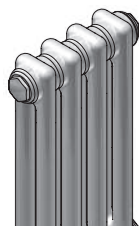
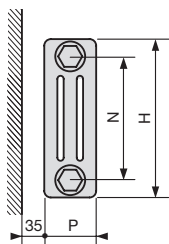

MODELO	2250	3250	4250
Altura H	2.500 mm	2.500 mm	2.500 mm
Entre ejes N	2.434 mm	2.434 mm	2.434 mm
Profundidad P	62 mm	100 mm	136 mm
Exponente n	1,30	1,32	1,31

Recuerde pedir el Pack de Conexión

Longitud L	Elem.	mm	Emisión	Emisión	Emisión	Blanco	Emisión	Emisión	Emisión	Blanco	Emisión	Emisión	Emisión	Blanco
			EN 442 75/65/20 ΔT 50K W	Caldera condens. ΔT 40K W	Bomba de calor ΔT 32,5K W	RAL 9016 PVP €	EN 442 75/65/20 ΔT 50K W	Caldera condens. ΔT 40K W	Bomba de calor ΔT 32,5K W	RAL 9016 PVP €	EN 442 75/65/20 ΔT 50K W	Caldera condens. ΔT 40K W	Bomba de calor ΔT 32,5K W	RAL 9016 PVP €
4	184	684	512	391	258,51	900	670	510	346,79	1.156	863	657	412,59	
5	230	855	640	488	316,17	1.125	838	637	426,52	1.445	1.079	822	508,77	
6	276	1.026	768	586	373,83	1.350	1.006	765	506,25	1.734	1.294	986	604,95	
7	322	1.197	896	684	431,49	1.575	1.173	892	585,98	2.023	1.510	1.151	701,13	
8	368	1.368	1.024	781	489,15	1.800	1.341	1.019	665,71	2.312	1.726	1.315	797,31	
9	414	1.539	1.151	879	560,74	2.025	1.508	1.147	759,37	2.601	1.942	1.479	907,42	
10	460	1.710	1.279	977	618,40	2.250	1.676	1.274	839,10	2.890	2.157	1.644	1.003,60	
11	506	1.881	1.407	1.074	676,06	2.475	1.844	1.402	918,83	3.179	2.373	1.808	1.099,78	
12	552	2.052	1.535	1.172	733,72	2.700	2.011	1.529	998,56	3.468	2.589	1.972	1.195,96	
13	598	2.223	1.663	1.270	791,38	2.925	2.179	1.656	1.078,29	3.757	2.805	2.137	1.292,14	
14	644	2.394	1.791	1.367	849,04	3.150	2.346	1.784	1.158,02	4.046	3.020	2.301	1.388,32	
15	690	2.565	1.919	1.465	906,70	3.375	2.514	1.911	1.237,75	4.335	3.236	2.466	1.484,50	
16	736	2.736	2.047	1.563	978,28	3.600	2.682	2.039	1.331,40	4.624	3.452	2.630	1.594,60	
17	782	2.907	2.175	1.660	1.035,94	3.825	2.849	2.166	1.411,13	4.913	3.668	2.794	1.690,78	
18	828	3.078	2.303	1.758	1.093,60	4.050	3.017	2.294	1.490,86	5.202	3.883	2.959	1.786,96	
19	874	3.249	2.431	1.856	1.151,26	4.275	3.184	2.421	1.570,59	5.491	4.099	3.123	1.883,14	
20	920	3.420	2.559	1.954	1.208,92	4.500	3.352	2.548	1.650,32	5.780	4.315	3.287	1.979,32	
21	966	3.591	2.687	2.051	1.266,58	4.725	3.519	2.676	1.730,05	6.069	4.531	3.452	2.075,50	
22	1.012	3.762	2.815	2.149	1.324,24	4.950	3.687	2.803	1.809,78	6.358	4.746	3.616	2.171,68	
23	1.058	3.933	2.943	2.247	1.395,03	5.175	3.855	2.931	1.902,64	6.647	4.962	3.780	2.280,99	
24	1.104	4.104	3.071	2.344	1.452,69	5.400	4.022	3.058	1.982,37	6.936	5.178	3.945	2.377,17	
25	1.150	4.275	3.199	2.442	1.510,35	5.625	4.190	3.185	2.062,10	7.225	5.394	4.109	2.473,35	
26	1.196	4.446	3.326	2.540	1.568,01	5.850	4.357	3.313	2.141,83	7.514	5.609	4.274	2.569,53	
27	1.242	4.617	3.454	2.637	1.625,67	6.075	4.525	3.440	2.221,56	7.803	5.825	4.438	2.665,71	
28	1.288	4.788	3.582	2.735	1.683,33	6.300	4.693	3.568	2.301,29	8.092	6.041	4.602	2.761,89	
29	1.334	4.959	3.710	2.833	1.740,99	6.525	4.860	3.695	2.381,02	8.381	6.257	4.767	2.858,07	

Precios para color blanco estándar RAL 9016.

Precios para carta de colores Zehnder +25%. Otros colores, consultar.





# Zehnder Charleston

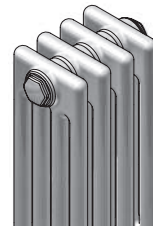
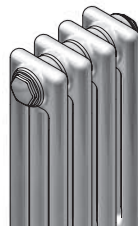
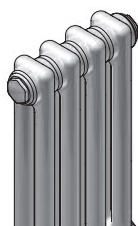
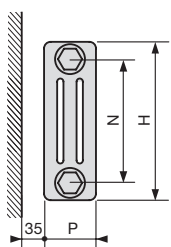

MODELO	2280	3280	4280
Altura H	2.800 mm	2.800 mm	2.800 mm
Entre ejes N	2.734 mm	2.734 mm	2.734 mm
Profundidad P	62 mm	100 mm	136 mm
Exponente n	1,30	1,30	1,30

Recuerde pedir el Pack de Conexión

Longitud L	Elem.	mm	Emisión	Emisión	Emisión	Blanco	Emisión	Emisión	Emisión	Blanco	Emisión	Emisión	Emisión	Blanco
			EN 442 75/65/20 ΔT 50K W	Caldera condens. ΔT 40K W	Bomba de calor ΔT 32,5K W	RAL 9016 PVP €	EN 442 75/65/20 ΔT 50K W	Caldera condens. ΔT 40K W	Bomba de calor ΔT 32,5K W	RAL 9016 PVP €	EN 442 75/65/20 ΔT 50K W	Caldera condens. ΔT 40K W	Bomba de calor ΔT 32,5K W	RAL 9016 PVP €
4	184	756	566	432	296,79	1.004	751	573	419,59	1.292	967	738	542,63	
5	230	945	707	540	364,02	1.255	939	717	517,52	1.615	1.208	922	671,32	
6	276	1.134	848	648	431,25	1.506	1.127	860	615,45	1.938	1.450	1.107	800,01	
7	322	1.323	990	756	498,48	1.757	1.315	1.004	713,38	2.261	1.692	1.291	928,70	
8	368	1.512	1.131	864	565,71	2.008	1.502	1.147	811,31	2.584	1.933	1.476	1.057,39	
9	414	1.701	1.273	972	646,87	2.259	1.690	1.290	923,17	2.907	2.175	1.660	1.200,01	
10	460	1.890	1.414	1.080	714,10	2.510	1.878	1.434	1.021,10	3.230	2.417	1.845	1.328,70	
11	506	2.079	1.556	1.188	781,33	2.761	2.066	1.577	1.119,03	3.553	2.658	2.029	1.457,39	
12	552	2.268	1.697	1.295	848,56	3.012	2.254	1.720	1.216,96	3.876	2.900	2.214	1.586,08	
13	598	2.457	1.838	1.403	915,79	3.263	2.441	1.864	1.314,89	4.199	3.142	2.398	1.714,77	
14	644	2.646	1.980	1.511	983,02	3.514	2.629	2.007	1.412,82	4.522	3.383	2.583	1.843,46	
15	690	2.835	2.121	1.619	1.050,25	3.765	2.817	2.151	1.510,75	4.845	3.625	2.767	1.972,15	
16	736	3.024	2.263	1.727	1.131,40	4.016	3.005	2.294	1.622,60	5.168	3.867	2.952	2.114,76	
17	782	3.213	2.404	1.835	1.198,63	4.267	3.193	2.437	1.720,53	5.491	4.108	3.136	2.243,45	
18	828	3.402	2.545	1.943	1.265,86	4.518	3.380	2.581	1.818,46	5.814	4.350	3.321	2.372,14	
19	874	3.591	2.687	2.051	1.333,09	4.769	3.568	2.724	1.916,39	6.137	4.592	3.505	2.500,83	
20	920	3.780	2.828	2.159	1.400,32	5.020	3.756	2.867	2.014,32	6.460	4.833	3.690	2.629,52	
21	966	3.969	2.970	2.267	1.467,55	5.271	3.944	3.011	2.112,25	6.783	5.075	3.874	2.758,21	
22	1.012	4.158	3.111	2.375	1.534,78	5.522	4.132	3.154	2.210,18	7.106	5.317	4.059	2.886,90	
23	1.058	4.347	3.252	2.483	1.615,14	5.773	4.319	3.298	2.321,24	7.429	5.558	4.243	3.028,72	
24	1.104	4.536	3.394	2.591	1.682,37	6.024	4.507	3.441	2.419,17	7.752	5.800	4.428	3.157,41	
25	1.150	4.725	3.535	2.699	1.749,60	6.275	4.695	3.584	2.517,10	8.075	6.042	4.612	3.286,10	
26	1.196	4.914	3.677	2.807	1.816,83	6.526	4.883	3.728	2.615,03	8.398	6.283	4.797	3.414,79	
27	1.242	5.103	3.818	2.915	1.884,06	6.777	5.071	3.871	2.712,96	8.721	6.525	4.981	3.543,48	
28	1.288	5.292	3.959	3.023	1.951,29	7.028	5.258	4.014	2.810,89	9.044	6.767	5.166	3.672,17	
29	1.334	5.481	4.101	3.131	2.018,52	7.279	5.446	4.158	2.908,82	9.367	7.008	5.350	3.800,86	

Precios para color blanco estándar RAL 9016.

Precios para carta de colores Zehnder +25%. Otros colores, consultar.



# Zehnder Charleston

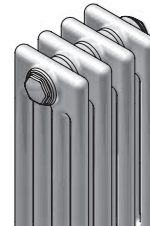
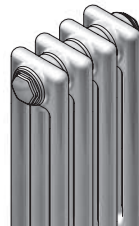
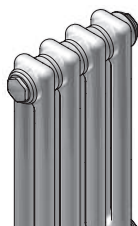
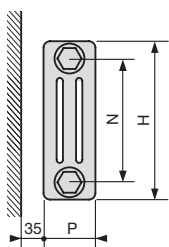

MODELO	2300	3300	4300
Altura H	3.000 mm	3.000 mm	3.000 mm
Entre ejes N	2.934 mm	2.934 mm	2.934 mm
Profundidad P	62 mm	100 mm	136 mm
Exponente n	1,30	1,30	1,30

Recuerde pedir el Pack de Conexión

Longitud L	Elem.	mm	Emisión	Emisión	Emisión	Blanco	Emisión	Emisión	Emisión	Blanco	Emisión	Emisión	Emisión	Blanco
			EN 442 75/65/20 ΔT 50K W	Caldera condens. ΔT 40K W	Bomba de calor ΔT 32,5K W	RAL 9016 PVP €	EN 442 75/65/20 ΔT 50K W	Caldera condens. ΔT 40K W	Bomba de calor ΔT 32,5K W	RAL 9016 PVP €	EN 442 75/65/20 ΔT 50K W	Caldera condens. ΔT 40K W	Bomba de calor ΔT 32,5K W	RAL 9016 PVP €
4	184	804	602	459	324,71	1.076	805	615	466,83	1.380	1.033	788	601,75	
5	230	1.005	752	574	398,92	1.345	1.006	768	576,57	1.725	1.291	985	745,22	
6	276	1.206	902	689	473,13	1.614	1.208	922	686,31	2.070	1.549	1.182	888,69	
7	322	1.407	1.053	804	547,34	1.883	1.409	1.076	796,05	2.415	1.807	1.379	1.032,16	
8	368	1.608	1.203	918	621,55	2.152	1.610	1.229	905,79	2.760	2.065	1.577	1.175,63	
9	414	1.809	1.353	1.033	709,69	2.421	1.811	1.383	1.029,46	3.105	2.323	1.774	1.333,03	
10	460	2.010	1.504	1.148	783,90	2.690	2.013	1.537	1.139,20	3.450	2.581	1.971	1.476,50	
11	506	2.211	1.654	1.263	858,11	2.959	2.214	1.690	1.248,94	3.795	2.839	2.168	1.619,97	
12	552	2.412	1.805	1.378	932,32	3.228	2.415	1.844	1.358,68	4.140	3.098	2.365	1.763,44	
13	598	2.613	1.955	1.493	1.006,53	3.497	2.616	1.997	1.468,42	4.485	3.356	2.562	1.906,91	
14	644	2.814	2.105	1.607	1.080,74	3.766	2.818	2.151	1.578,16	4.830	3.614	2.759	2.050,38	
15	690	3.015	2.256	1.722	1.154,95	4.035	3.019	2.305	1.687,90	5.175	3.872	2.956	2.193,85	
16	736	3.216	2.406	1.837	1.243,08	4.304	3.220	2.458	1.811,56	5.520	4.130	3.153	2.351,24	
17	782	3.417	2.557	1.952	1.317,29	4.573	3.422	2.612	1.921,30	5.865	4.388	3.350	2.494,71	
18	828	3.618	2.707	2.067	1.391,50	4.842	3.623	2.766	2.031,04	6.210	4.646	3.547	2.638,18	
19	874	3.819	2.857	2.181	1.465,71	5.111	3.824	2.919	2.140,78	6.555	4.904	3.744	2.781,65	
20	920	4.020	3.008	2.296	1.539,92	5.380	4.025	3.073	2.250,52	6.900	5.163	3.941	2.925,12	
21	966	4.221	3.158	2.411	1.614,13	5.649	4.227	3.227	2.360,26	7.245	5.421	4.138	3.068,59	
22	1.012	4.422	3.309	2.526	1.688,34	5.918	4.428	3.380	2.470,00	7.590	5.679	4.335	3.212,06	
23	1.058	4.623	3.459	2.641	1.775,68	6.187	4.629	3.534	2.592,87	7.935	5.937	4.532	3.368,66	
24	1.104	4.824	3.609	2.755	1.849,89	6.456	4.830	3.688	2.702,61	8.280	6.195	4.730	3.512,13	
25	1.150	5.025	3.760	2.870	1.924,10	6.725	5.032	3.841	2.812,35	8.625	6.453	4.927	3.655,60	
26	1.196	5.226	3.910	2.985	1.998,31	6.994	5.233	3.995	2.922,09	8.970	6.711	5.124	3.799,07	
27	1.242	5.427	4.060	3.100	2.072,52	7.263	5.434	4.149	3.031,83	9.315	6.969	5.321	3.942,54	
28	1.288	5.628	4.211	3.215	2.146,73	7.532	5.635	4.302	3.141,57	9.660	7.228	5.518	4.086,01	
29	1.334	5.829	4.361	3.330	2.220,94	7.801	5.837	4.456	3.251,31	10.005	7.486	5.715	4.229,48	

Precios para color blanco estándar RAL 9016.

Precios para carta de colores Zehnder +25%. Otros colores, consultar.





# Zehnder Charleston

## Retrofit

Zehnder Charleston Retrofit: el original entre los radiadores multicolumna especial para sustitución en reformas. Uso versátil gracias a la amplia diversidad de modelos, sujeciones y conexiones para antiguos radiadores tradicionales, radiadores de aluminio y radiadores de hierro fundido sin necesidad de realizar una adaptación de tubería.



# Zehnder Charleston

## Retrofit

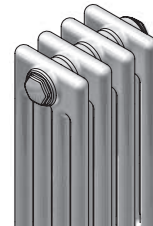
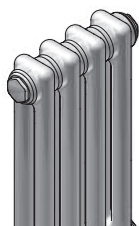
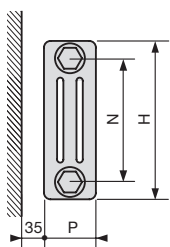

MODELO	2041	3042	4042
Altura H	408 mm	416 mm	416 mm
Entre ejes N	350 mm	350 mm	350 mm
Profundidad P	62 mm	100 mm	136 mm
Exponente n	1,24	1,25	1,26

Recuerde pedir el Pack de Conexión

Longitud L	Elem.	mm	Modelo 2041				Modelo 3042				Modelo 4042			
			Emisión EN 442 75/65/20 ΔT 50K W	Emisión Caldera condens. ΔT 40K W	Emisión Bomba de calor ΔT 32,5K W	Blanco RAL 9016 PVP €	Emisión EN 442 75/65/20 ΔT 50K W	Emisión Caldera condens. ΔT 40K W	Emisión Bomba de calor ΔT 32,5K W	Blanco RAL 9016 PVP €	Emisión EN 442 75/65/20 ΔT 50K W	Emisión Caldera condens. ΔT 40K W	Emisión Bomba de calor ΔT 32,5K W	Blanco RAL 9016 PVP €
4	184	128	97	75	102,35	172	130	100	112,99	228	172	132	137,91	
5	230	160	121	94	120,97	215	163	125	134,27	285	215	166	165,42	
6	276	192	146	113	139,59	258	195	151	155,55	342	258	199	192,93	
7	322	224	170	131	158,21	301	228	176	176,83	399	301	232	220,44	
8	368	256	194	150	176,83	344	260	201	198,11	456	344	265	247,95	
9	414	288	218	169	195,45	387	293	226	219,39	513	387	298	275,46	
10	460	320	243	188	214,07	430	325	251	240,67	570	430	331	302,97	
11	506	352	267	206	232,69	473	358	276	261,95	627	473	364	330,48	
12	552	384	291	225	251,31	516	390	301	283,23	684	516	397	357,99	
13	598	416	315	244	269,93	559	423	326	304,51	741	559	431	385,50	
14	644	448	340	263	288,55	602	455	351	325,79	798	602	464	413,01	
15	690	480	364	281	307,17	645	488	376	347,07	855	645	497	440,52	
16	736	512	388	300	325,79	688	521	402	368,35	912	688	530	468,03	
17	782	544	413	319	344,41	731	553	427	389,63	969	732	563	495,54	
18	828	576	437	338	363,03	774	586	452	410,91	1.026	775	596	523,05	
19	874	608	461	356	381,65	817	618	477	432,19	1.083	818	629	550,56	
20	920	640	485	375	400,27	860	651	502	453,47	1.140	861	662	578,07	
21	966	672	510	394	418,89	903	683	527	474,75	1.197	904	696	605,58	
22	1.012	704	534	413	437,51	946	716	552	496,03	1.254	947	729	633,09	
23	1.058	736	558	431	470,06	989	748	577	531,24	1.311	990	762	674,53	
24	1.104	768	582	450	488,68	1.032	781	602	552,52	1.368	1.033	795	702,04	
25	1.150	800	607	469	507,30	1.075	813	627	573,80	1.425	1.076	828	729,55	
26	1.196	832	631	488	525,92	1.118	846	653	595,08	1.482	1.119	861	757,06	
27	1.242	864	655	506	544,54	1.161	878	678	616,36	1.539	1.162	894	784,57	
28	1.288	896	679	525	563,16	1.204	911	703	637,64	1.596	1.205	927	812,08	
29	1.334	928	704	544	581,78	1.247	943	728	658,92	1.653	1.248	961	839,59	
30	1.380	960	728	563	600,40	1.290	976	753	680,20	1.710	1.291	994	867,10	
31	1.426	992	752	581	619,02	1.333	1.009	778	701,48	1.767	1.334	1.027	894,61	
32	1.472	1.024	776	600	637,64	1.376	1.041	803	722,76	1.824	1.377	1.060	922,12	
33	1.518	1.056	801	619	656,26	1.419	1.074	828	744,04	1.881	1.420	1.093	949,63	
34	1.564	1.088	825	638	674,88	1.462	1.106	853	765,32	1.938	1.463	1.126	977,14	
35	1.610	1.120	849	656	693,50	1.505	1.139	878	786,60	1.995	1.506	1.159	1.004,65	
36	1.656	1.152	874	675	712,12	1.548	1.171	903	807,88	2.052	1.549	1.192	1.032,16	
37	1.702	1.184	898	694	730,74	1.591	1.204	929	829,16	2.109	1.592	1.226	1.059,67	
38	1.748	1.216	922	713	749,36	1.634	1.236	954	850,44	2.166	1.635	1.259	1.087,18	
39	1.794	1.248	946	732	767,98	1.677	1.269	979	871,72	2.223	1.678	1.292	1.114,69	
40	1.840	1.280	971	750	800,52	1.720	1.301	1.004	906,92	2.280	1.721	1.325	1.156,12	

Precios para color blanco estándar RAL 9016.

Precios para carta de colores Zehnder +25%. Otros colores, consultar.



# Zehnder Charleston

## Retrofit

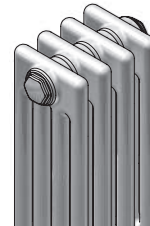
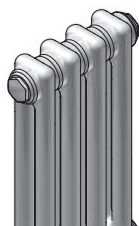
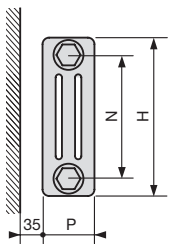

MODELO	2056	3057	4057
Altura H	558 mm	566 mm	566 mm
Entre ejes N	500 mm	500 mm	500 mm
Profundidad P	62 mm	100 mm	136 mm
Exponente n	1,30	1,26	1,27

Recuerde pedir el Pack de Conexión

Elem.	Longitud L mm	Emisión EN 442	Emisión Caldera condens.	Emisión Bomba de calor	Blanco RAL 9016	Emisión EN 442	Emisión Caldera condens.	Emisión Bomba de calor	Blanco RAL 9016	Emisión EN 442	Emisión Caldera condens.	Emisión Bomba de calor	Blanco RAL 9016
		75/65/20 ΔT 50K W	ΔT 40K W	ΔT 32,5K W	PVP €	75/65/20 ΔT 50K W	ΔT 40K W	ΔT 32,5K W	PVP €	75/65/20 ΔT 50K W	ΔT 40K W	ΔT 32,5K W	PVP €
4	184	168	126	96	103,03	228	172	132	105,15	296	223	171	117,19
5	230	210	157	120	121,82	285	215	166	124,47	370	279	214	139,52
6	276	252	189	144	140,61	342	258	199	143,79	444	334	257	161,85
7	322	294	220	168	159,40	399	301	232	163,11	518	390	300	184,18
8	368	336	251	192	178,19	456	344	265	182,43	592	446	343	206,51
9	414	378	283	216	196,98	513	387	298	201,75	666	502	385	228,84
10	460	420	314	240	215,77	570	430	331	221,07	740	557	428	251,17
11	506	462	346	264	234,56	627	473	364	240,39	814	613	471	273,50
12	552	504	377	288	253,35	684	516	397	259,71	888	669	514	295,83
13	598	546	409	312	272,14	741	559	431	279,03	962	725	557	318,16
14	644	588	440	336	290,93	798	602	464	298,35	1.036	780	599	340,49
15	690	630	471	360	309,72	855	645	497	317,67	1.110	836	642	362,82
16	736	672	503	384	328,51	912	688	530	336,99	1.184	892	685	385,15
17	782	714	534	408	347,30	969	732	563	356,31	1.258	948	728	407,48
18	828	756	566	432	366,09	1.026	775	596	375,63	1.332	1.003	771	429,81
19	874	798	597	456	384,88	1.083	818	629	394,95	1.406	1.059	814	452,14
20	920	840	628	480	403,67	1.140	861	662	414,27	1.480	1.115	856	474,47
21	966	882	660	504	422,46	1.197	904	696	433,59	1.554	1.171	899	496,80
22	1.012	924	691	528	441,25	1.254	947	729	452,91	1.628	1.226	942	519,13
23	1.058	966	723	552	473,97	1.311	990	762	486,16	1.702	1.282	985	555,39
24	1.104	1.008	754	576	492,76	1.368	1.033	795	505,48	1.776	1.338	1.028	577,72
25	1.150	1.050	786	600	511,55	1.425	1.076	828	524,80	1.850	1.393	1.070	600,05
26	1.196	1.092	817	624	530,34	1.482	1.119	861	544,12	1.924	1.449	1.113	622,38
27	1.242	1.134	848	648	549,13	1.539	1.162	894	563,44	1.998	1.505	1.156	644,71
28	1.288	1.176	880	672	567,92	1.596	1.205	927	582,76	2.072	1.561	1.199	667,04
29	1.334	1.218	911	696	586,71	1.653	1.248	961	602,08	2.146	1.616	1.242	689,37
30	1.380	1.260	943	720	605,50	1.710	1.291	994	621,40	2.220	1.672	1.285	711,70
31	1.426	1.302	974	744	624,29	1.767	1.334	1.027	640,72	2.294	1.728	1.327	734,03
32	1.472	1.344	1.006	768	643,08	1.824	1.377	1.060	660,04	2.368	1.784	1.370	756,36
33	1.518	1.386	1.037	792	661,87	1.881	1.420	1.093	679,36	2.442	1.839	1.413	778,69
34	1.564	1.428	1.068	816	680,66	1.938	1.463	1.126	698,68	2.516	1.895	1.456	801,02
35	1.610	1.470	1.100	840	699,45	1.995	1.506	1.159	718,00	2.590	1.951	1.499	823,35
36	1.656	1.512	1.131	864	718,24	2.052	1.549	1.192	737,32	2.664	2.007	1.541	845,68
37	1.702	1.554	1.163	888	737,03	2.109	1.592	1.226	756,64	2.738	2.062	1.584	868,01
38	1.748	1.596	1.194	912	755,82	2.166	1.635	1.259	775,96	2.812	2.118	1.627	890,34
39	1.794	1.638	1.226	936	774,61	2.223	1.678	1.292	795,28	2.886	2.174	1.670	912,67
40	1.840	1.680	1.257	960	807,32	2.280	1.721	1.325	828,52	2.960	2.230	1.713	948,92

Precios para color blanco estándar RAL 9016.

Precios para carta de colores Zehnder +25%. Otros colores, consultar.



# Zehnder Charleston

## Retrofit

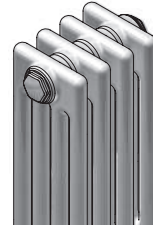
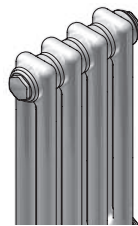
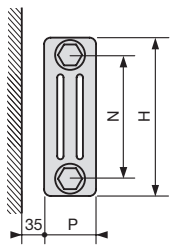

MODELO	2066	3067	4067
Altura H	658 mm	666 mm	666 mm
Entre ejes N	600 mm	600 mm	600 mm
Profundidad P	62 mm	100 mm	136 mm
Exponente n	1,30	1,26	1,27

Recuerde pedir el Pack de Conexión

Longitud L	Elem.	mm	Emisión	Emisión	Emisión	Blanco	Emisión	Emisión	Emisión	Blanco	Emisión	Emisión	Emisión	Blanco
			EN 442 75/65/20 ΔT 50K W	Caldera condens. ΔT 40K W	Bomba de calor ΔT 32,5K W	RAL 9016 PVP €	EN 442 75/65/20 ΔT 50K W	Caldera condens. ΔT 40K W	Bomba de calor ΔT 32,5K W	RAL 9016 PVP €	EN 442 75/65/20 ΔT 50K W	Caldera condens. ΔT 40K W	Bomba de calor ΔT 32,5K W	RAL 9016 PVP €
4	184	192	144	110	106,91	268	202	156	109,63	344	259	199	125,79	
5	230	240	180	137	126,67	335	253	195	130,07	430	324	249	150,27	
6	276	288	215	165	146,43	402	303	234	150,51	516	389	299	174,75	
7	322	336	251	192	166,19	469	354	273	170,95	602	453	348	199,23	
8	368	384	287	219	185,95	536	405	311	191,39	688	518	398	223,71	
9	414	432	323	247	205,71	603	455	350	211,83	774	583	448	248,19	
10	460	480	359	274	225,47	670	506	389	232,27	860	648	498	272,67	
11	506	528	395	302	245,23	737	556	428	252,71	946	713	547	297,15	
12	552	576	431	329	264,99	804	607	467	273,15	1.032	777	597	321,63	
13	598	624	467	356	284,75	871	658	506	293,59	1.118	842	647	346,11	
14	644	672	503	384	304,51	938	708	545	314,03	1.204	907	697	370,59	
15	690	720	539	411	324,27	1.005	759	584	334,47	1.290	972	746	395,07	
16	736	768	575	439	344,03	1.072	809	623	354,91	1.376	1.036	796	419,55	
17	782	816	611	466	363,79	1.139	860	662	375,35	1.462	1.101	846	444,03	
18	828	864	646	494	383,55	1.206	910	701	395,79	1.548	1.166	896	468,51	
19	874	912	682	521	403,31	1.273	961	740	416,23	1.634	1.231	945	492,99	
20	920	960	718	548	423,07	1.340	1.012	779	436,67	1.720	1.296	995	517,47	
21	966	1.008	754	576	442,83	1.407	1.062	818	457,11	1.806	1.360	1.045	541,95	
22	1.012	1.056	790	603	462,59	1.474	1.113	857	477,55	1.892	1.425	1.095	566,43	
23	1.058	1.104	826	631	496,28	1.541	1.163	896	511,92	1.978	1.490	1.145	604,84	
24	1.104	1.152	862	658	516,04	1.608	1.214	934	532,36	2.064	1.555	1.194	629,32	
25	1.150	1.200	898	685	535,80	1.675	1.264	973	552,80	2.150	1.619	1.244	653,80	
26	1.196	1.248	934	713	555,56	1.742	1.315	1.012	573,24	2.236	1.684	1.294	678,28	
27	1.242	1.296	970	740	575,32	1.809	1.366	1.051	593,68	2.322	1.749	1.344	702,76	
28	1.288	1.344	1.006	768	595,08	1.876	1.416	1.090	614,12	2.408	1.814	1.393	727,24	
29	1.334	1.392	1.041	795	614,84	1.943	1.467	1.129	634,56	2.494	1.879	1.443	751,72	
30	1.380	1.440	1.077	823	634,60	2.010	1.517	1.168	655,00	2.580	1.943	1.493	776,20	
31	1.426	1.488	1.113	850	654,36	2.077	1.568	1.207	675,44	2.666	2.008	1.543	800,68	
32	1.472	1.536	1.149	877	674,12	2.144	1.619	1.246	695,88	2.752	2.073	1.592	825,16	
33	1.518	1.584	1.185	905	693,88	2.211	1.669	1.285	716,32	2.838	2.138	1.642	849,64	
34	1.564	1.632	1.221	932	713,64	2.278	1.720	1.324	736,76	2.924	2.202	1.692	874,12	
35	1.610	1.680	1.257	960	733,40	2.345	1.770	1.363	757,20	3.010	2.267	1.742	898,60	
36	1.656	1.728	1.293	987	753,16	2.412	1.821	1.402	777,64	3.096	2.332	1.791	923,08	
37	1.702	1.776	1.329	1.014	772,92	2.479	1.871	1.441	798,08	3.182	2.397	1.841	947,56	
38	1.748	1.824	1.365	1.042	792,68	2.546	1.922	1.480	818,52	3.268	2.462	1.891	972,04	
39	1.794	1.872	1.401	1.069	812,44	2.613	1.973	1.518	838,96	3.354	2.526	1.941	996,52	
40	1.840	1.920	1.437	1.097	846,12	2.680	2.023	1.557	873,32	3.440	2.591	1.990	1.034,92	

Precios para color blanco estándar RAL 9016.

Precios para carta de colores Zehnder +25%. Otros colores, consultar.



# Zehnder Charleston

## Retrofit

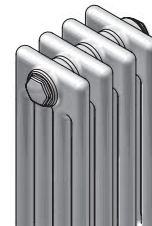
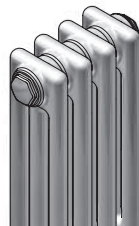
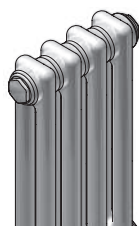
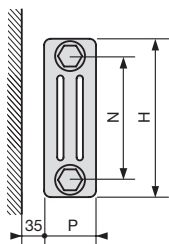

MODELO	2068	3069	4069
Altura H	678 mm	686 mm	686 mm
Entre ejes N	620 mm	620 mm	620 mm
Profundidad P	62 mm	100 mm	136 mm
Exponente n	1,30	1,26	1,27

Recuerde pedir el Pack de Conexión

Longitud L	Elem.	mm	Emisión	Emisión	Emisión	Blanco	Emisión	Emisión	Emisión	Blanco	Emisión	Emisión	Emisión	Blanco
			EN 442 75/65/20 ΔT 50K W	Caldera condens. ΔT 40K W	Bomba de calor ΔT 32,5K W	RAL 9016 PVP €	EN 442 75/65/20 ΔT 50K W	Caldera condens. ΔT 40K W	Bomba de calor ΔT 32,5K W	RAL 9016 PVP €	EN 442 75/65/20 ΔT 50K W	Caldera condens. ΔT 40K W	Bomba de calor ΔT 32,5K W	RAL 9016 PVP €
4	184	199	149	114	129,99	281	212	163	136,07	360	271	208	154,51	
5	230	249	186	142	155,52	351	265	204	163,12	450	339	260	186,17	
6	276	299	224	171	181,05	421	318	245	190,17	539	406	312	217,83	
7	322	349	261	199	206,58	491	371	286	217,22	629	474	364	249,49	
8	368	398	298	228	232,11	562	424	326	244,27	719	542	416	281,15	
9	414	448	335	256	257,64	632	477	367	271,32	809	609	468	312,81	
10	460	498	373	284	283,17	702	530	408	298,37	899	677	520	344,47	
11	506	548	410	313	308,70	772	583	449	325,42	989	745	572	376,13	
12	552	598	447	341	334,23	842	636	490	352,47	1.079	813	624	407,79	
13	598	647	484	370	359,76	913	689	530	379,52	1.169	880	676	439,45	
14	644	697	522	398	385,29	983	742	571	406,57	1.259	948	728	471,11	
15	690	747	559	427	410,82	1.053	795	612	433,62	1.349	1.016	780	502,77	
16	736	797	596	455	436,35	1.123	848	653	460,67	1.438	1.083	832	534,43	
17	782	847	633	484	461,88	1.193	901	694	487,72	1.528	1.151	884	566,09	
18	828	896	671	512	487,41	1.264	954	734	514,77	1.618	1.219	936	597,75	
19	874	946	708	540	512,94	1.334	1.007	775	541,82	1.708	1.287	988	629,41	
20	920	996	745	569	538,47	1.404	1.060	816	568,87	1.798	1.354	1.040	661,07	
21	966	1.046	782	597	564,00	1.474	1.113	857	595,92	1.888	1.422	1.092	692,73	
22	1.012	1.096	820	626	589,53	1.544	1.166	897	622,97	1.978	1.490	1.144	724,39	
23	1.058	1.145	857	654	628,99	1.615	1.219	938	663,95	2.068	1.557	1.196	769,98	
24	1.104	1.195	894	683	654,52	1.685	1.272	979	691,00	2.158	1.625	1.248	801,64	
25	1.150	1.245	932	711	680,05	1.755	1.325	1.020	718,05	2.248	1.693	1.300	833,30	
26	1.196	1.295	969	740	705,58	1.825	1.378	1.061	745,10	2.337	1.761	1.352	864,96	
27	1.242	1.345	1.006	768	731,11	1.895	1.431	1.101	772,15	2.427	1.828	1.405	896,62	
28	1.288	1.394	1.043	796	756,64	1.966	1.484	1.142	799,20	2.517	1.896	1.457	928,28	
29	1.334	1.444	1.081	825	782,17	2.036	1.537	1.183	826,25	2.607	1.964	1.509	959,94	
30	1.380	1.494	1.118	853	807,70	2.106	1.590	1.224	853,30	2.697	2.031	1.561	991,60	
31	1.426	1.544	1.155	882	833,23	2.176	1.643	1.265	880,35	2.787	2.099	1.613	1.023,26	
32	1.472	1.594	1.192	910	858,76	2.246	1.696	1.305	907,40	2.877	2.167	1.665	1.054,92	
33	1.518	1.643	1.230	939	884,29	2.317	1.749	1.346	934,45	2.967	2.235	1.717	1.086,58	
34	1.564	1.693	1.267	967	909,82	2.387	1.802	1.387	961,50	3.057	2.302	1.769	1.118,24	
35	1.610	1.743	1.304	996	935,35	2.457	1.855	1.428	988,55	3.147	2.370	1.821	1.149,90	
36	1.656	1.793	1.341	1.024	960,88	2.527	1.908	1.469	1.015,60	3.236	2.438	1.873	1.181,56	
37	1.702	1.843	1.379	1.052	986,41	2.597	1.961	1.509	1.042,65	3.326	2.505	1.925	1.213,22	
38	1.748	1.892	1.416	1.081	1.011,94	2.668	2.014	1.550	1.069,70	3.416	2.573	1.977	1.244,88	
39	1.794	1.942	1.453	1.109	1.037,47	2.738	2.067	1.591	1.096,75	3.506	2.641	2.029	1.276,54	
40	1.840	1.992	1.490	1.138	1.076,92	2.808	2.120	1.632	1.137,72	3.596	2.709	2.081	1.322,12	

Precios para color blanco estándar RAL 9016.

Precios para carta de colores Zehnder +25%. Otros colores, consultar.





# Zehnder Charleston

## Retrofit

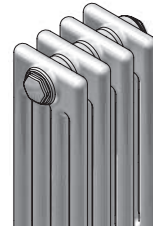
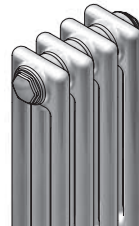
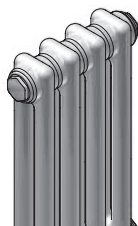
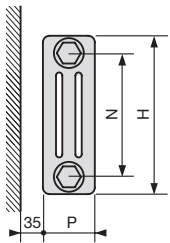

MODELO	2071	3072	4072
Altura H	708 mm	716 mm	716 mm
Entre ejes N	650 mm	650 mm	650 mm
Profundidad P	62 mm	100 mm	136 mm
Exponente n	1,30	1,26	1,27

Recuerde pedir el Pack de Conexión

Longitud L	Elem.	mm	Emisión	Emisión	Emisión	Blanco	Emisión	Emisión	Emisión	Blanco	Emisión	Emisión	Emisión	Blanco
			EN 442 75/65/20 ΔT 50K W	Caldera condens. ΔT 40K W	Bomba de calor ΔT 32,5K W	RAL 9016 PVP €	EN 442 75/65/20 ΔT 50K W	Caldera condens. ΔT 40K W	Bomba de calor ΔT 32,5K W	RAL 9016 PVP €	EN 442 75/65/20 ΔT 50K W	Caldera condens. ΔT 40K W	Bomba de calor ΔT 32,5K W	RAL 9016 PVP €
4	184	212	159	121	129,99	300	226	174	147,43	392	295	227	168,31	
5	230	265	198	151	155,52	375	283	218	177,32	490	369	284	203,42	
6	276	318	238	182	181,05	450	340	262	207,21	588	443	340	238,53	
7	322	371	278	212	206,58	525	396	305	237,10	686	517	397	273,64	
8	368	424	317	242	232,11	600	453	349	266,99	784	591	454	308,75	
9	414	477	357	272	257,64	675	510	392	296,88	882	664	510	343,86	
10	460	530	397	303	283,17	750	566	436	326,77	980	738	567	378,97	
11	506	583	436	333	308,70	825	623	479	356,66	1.078	812	624	414,08	
12	552	636	476	363	334,23	900	679	523	386,55	1.176	886	680	449,19	
13	598	689	516	394	359,76	975	736	567	416,44	1.274	960	737	484,30	
14	644	742	555	424	385,29	1.050	793	610	446,33	1.372	1.033	794	519,41	
15	690	795	595	454	410,82	1.125	849	654	476,22	1.470	1.107	851	554,52	
16	736	848	634	484	436,35	1.200	906	697	506,11	1.568	1.181	907	589,63	
17	782	901	674	515	461,88	1.275	963	741	536,00	1.666	1.255	964	624,74	
18	828	954	714	545	487,41	1.350	1.019	785	565,89	1.764	1.329	1.021	659,85	
19	874	1.007	753	575	512,94	1.425	1.076	828	595,78	1.862	1.403	1.077	694,96	
20	920	1.060	793	605	538,47	1.500	1.132	872	625,67	1.960	1.476	1.134	730,07	
21	966	1.113	833	636	564,00	1.575	1.189	915	655,56	2.058	1.550	1.191	765,18	
22	1.012	1.166	872	666	589,53	1.650	1.246	959	685,45	2.156	1.624	1.248	800,29	
23	1.058	1.219	912	696	628,99	1.725	1.302	1.002	729,27	2.254	1.698	1.304	849,33	
24	1.104	1.272	952	727	654,52	1.800	1.359	1.046	759,16	2.352	1.772	1.361	884,44	
25	1.150	1.325	991	757	680,05	1.875	1.415	1.090	789,05	2.450	1.845	1.418	919,55	
26	1.196	1.378	1.031	787	705,58	1.950	1.472	1.133	818,94	2.548	1.919	1.474	954,66	
27	1.242	1.431	1.071	817	731,11	2.025	1.529	1.177	848,83	2.646	1.993	1.531	989,77	
28	1.288	1.484	1.110	848	756,64	2.100	1.585	1.220	878,72	2.744	2.067	1.588	1.024,88	
29	1.334	1.537	1.150	878	782,17	2.175	1.642	1.264	908,61	2.842	2.141	1.644	1.059,99	
30	1.380	1.590	1.190	908	807,70	2.250	1.699	1.308	938,50	2.940	2.214	1.701	1.095,10	
31	1.426	1.643	1.229	938	833,23	2.325	1.755	1.351	968,39	3.038	2.288	1.758	1.130,21	
32	1.472	1.696	1.269	969	858,76	2.400	1.812	1.395	998,28	3.136	2.362	1.815	1.165,32	
33	1.518	1.749	1.309	999	884,29	2.475	1.868	1.438	1.028,17	3.234	2.436	1.871	1.200,43	
34	1.564	1.802	1.348	1.029	909,82	2.550	1.925	1.482	1.058,06	3.332	2.510	1.928	1.235,54	
35	1.610	1.855	1.388	1.060	935,35	2.625	1.982	1.525	1.087,95	3.430	2.584	1.985	1.270,65	
36	1.656	1.908	1.428	1.090	960,88	2.700	2.038	1.569	1.117,84	3.528	2.657	2.041	1.305,76	
37	1.702	1.961	1.467	1.120	986,41	2.775	2.095	1.613	1.147,73	3.626	2.731	2.098	1.340,87	
38	1.748	2.014	1.507	1.150	1.011,94	2.850	2.151	1.656	1.177,62	3.724	2.805	2.155	1.375,98	
39	1.794	2.067	1.547	1.181	1.037,47	2.925	2.208	1.700	1.207,51	3.822	2.879	2.212	1.411,09	
40	1.840	2.120	1.586	1.211	1.076,92	3.000	2.265	1.743	1.251,32	3.920	2.953	2.268	1.460,12	

Precios para color blanco estándar RAL 9016.

Precios para carta de colores Zehnder +25%. Otros colores, consultar.



# Zehnder Charleston

## FIGURAS DE CONEXIÓN

**Conexiones Bitubo normales.** Sin suplemento de precio.

Misma mano



Cruzados

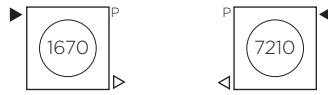

Lados opuestos

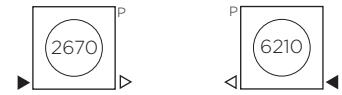

**Conexiones Bitubo especiales.** Con suplemento de precio **58,43 €.**

Desde abajo / hacia abajo



Desde arriba / hacia arriba

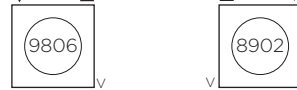

Desde abajo / hacia abajo

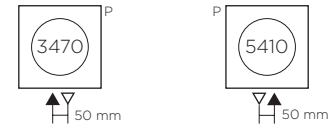

**Conexiones Mono-bitubo.** Con suplemento de precio **58,43 €.**

Para válvula Mono-Bitubo de 50 mm (Tipos P o Q).

Instalaciones Bitubo; *bypass* cerrado.

Instalaciones Monotubo; *bypass* abierto.

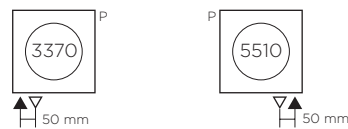

**Conexiones Monotubo.** Sin suplemento de precio.

La impulsión (entrada) debe ser por el exterior de la caña.

Válvula Tipo N. Las cañas deben ser lo más largas posibles.

Longitud máxima 26 elementos.

También es posible usar una conexión Mono-Bitubo con la válvula tipo P o Q con el *bypass* abierto.

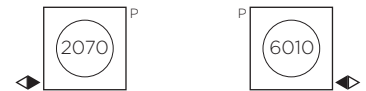

## MEDIDAS DE RACORES

Otras posiciones de racores, por ejemplo desde arriba hacia arriba, hacia atrás o adelante, pueden suministrarse bajo pedido, con suplemento de precio a consultar.

Conexiones laterales

**Modelos de 2 columnas Retrofit**

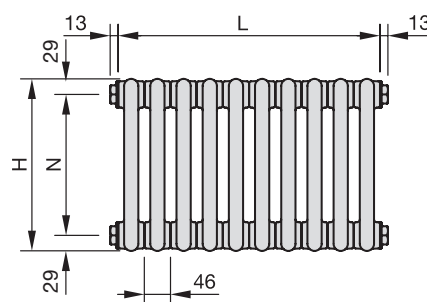

**Resto de modelos de 3-6 columnas**

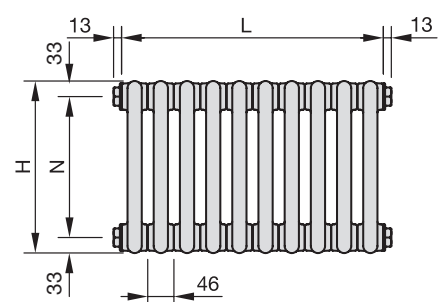

Conexiones inferiores

**Todos los modelos**

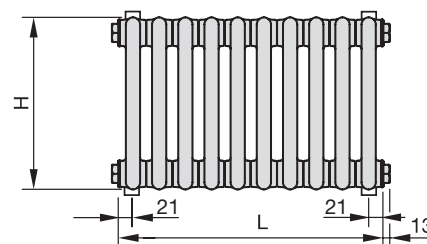

# Zehnder Charleston

## SOPORTES EASYFIX SMB

### Kit de soportes

Soportes a la pared SMB incluidos en el embalaje. En el color del radiador solo con el pedido inicial.

Cada radiador lleva el kit con su cantidad y tipo necesario de soportes murales (a la pared).

- Muy resistentes.
- Instalación rápida: reducen hasta un 33% el tiempo de montaje.
- Fáciles de colocar: evitan posibles errores y permiten una extracción segura.
- Invisibles: para un acabado perfecto.

### Kit de soportes adicional

Al pedir un kit de soportes adicional hay que indicar para qué radiador.

Juego de 2 soportes verticales SMB	PVP <b>27,87 €</b>
Juego de 3 soportes verticales SMB	PVP <b>41,80 €</b>
Juego de 4 soportes verticales SMB	PVP <b>55,72 €</b>



## SOPORTES SOLDADOS

Soldados en fábrica y con altura regulable. Solo disponibles con el pedido inicial.

Hasta 0,75 m de altura total, incluyendo la distancia del radiador al suelo, es suficiente con soportes inferiores.

A partir de 0,75 m de altura total es necesario prever soportes adicionales en la parte superior del radiador para asegurar la sujeción, incluidos en el radiador.

Distancia al suelo		Referencia	Blanco RAL 9016 PVP €
Altura mínima	Altura máxima		
120 mm	170 mm	Pie soldado Regulable 120-170	<b>104,00</b>
170 mm	350 mm	Pie soldado Regulable 170-350	<b>104,00</b>
Embellecedor para Pie Soldado			<b>15,64</b>



Base: Ø 100 mm



Embellecedor: Ø 105 mm

## SOPORTES PARA ATORNILLAR AL SUELO

Soportes para atornillar al suelo, de altura regulable. Es necesario prever soportes adicionales en la parte superior del radiador para asegurar la sujeción, incluidos en el radiador.

Distancia al suelo		Referencia	Blanco RAL 9016 PVP €
Altura mínima	Altura máxima		
140 mm	170 mm	754411	<b>104,00</b>
170 mm	350 mm	754421	<b>104,00</b>



Base: Ø 105 mm

## SOPORTES SLIP ON

**NOVEDAD**

Soportes para atornillar al suelo, de altura regulable. Es necesario prever soportes adicionales en la parte superior del radiador para asegurar la sujeción, incluidos en el radiador.

Modelos	Blanco RAL 9016		Carta de colores	
	Referencia	PVP €	Referencia	PVP €
2 columnas	722381	<b>44,67</b>	722389	<b>48,67</b>
3 columnas	722391	<b>45,33</b>	722399	<b>49,33</b>
4 columnas	733401	<b>46,00</b>	733409	<b>50,00</b>
5 columnas	722411	<b>46,67</b>	722419	<b>50,67</b>
6 columnas	722421	<b>47,33</b>	722429	<b>51,33</b>



Altura del pie: 100 mm.



# Zehnder Excelsior

Elegancia y versatilidad



Zehnder Excelsior es el radiador que convierte en realidad todo tipo de proyectos combinando calor, diseño y una personalidad indiscutible. Sus tubos planos ultrafinos, colocados de perfil, ofrecen una gran superficie radiante con una ligereza excepcional. Un diseño diáfano, ideal para dividir espacios y crear soluciones especiales que se integran, armoniosamente, en ambientes y estilos diferentes.



# Zehnder Excelsior

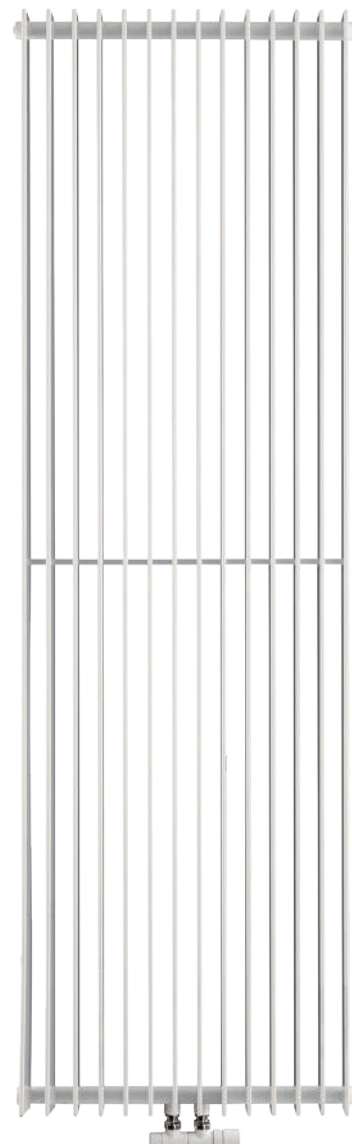

# Zehnder Excelsior

## VERSIONES Y ACABADOS

Disponible en versiones simples y dobles, siempre con tubos verticales. Orientación vertical y horizontal (ver página 97). Se suministra en color blanco (RAL 9016).

Disponible en los colores de la carta Zehnder (ver página 10).

Para otros colores o acabados, consultar.

### Ejecuciones especiales:

Radiadores en ángulo.

Radiadores curvos.

Radiadores con forma trapezoidal.

Longitudes o altura especiales.

Posición de racores especial y figuras de conexión distintas (ver página 124).

Alta presión.

Soportes de pie, de empotrar y soldados a consultar.

Separador de ambientes.

Todas las ejecuciones especiales deben ser consultadas para verificar disponibilidad y precio.

## SOPORTES

Soportes a la pared incluidos en el embalaje. En el color del radiador solo con el pedido inicial.

Otros soportes de pie, de empotrar, soldados, disponibles bajo pedido.

### Kit de soportes a la pared adicional:

Blanco estándar (RAL 9016).

PVP **54,67 €**

## PACK DE CONEXIÓN

Incluye todas las piezas necesarias para la conexión (ver página 257).

### Bitubo. Modelos horizontales:

Para la conexión estándar  
Juego de Válvula + Detentor. Tipo B.



Tipo B

### Monotubo. Modelos horizontales:

Válvula Monotubo Horizontal. Tipo N.  
Solo bajo pedido. Necesita que el radiador se fabrique especialmente.  
Hay que indicar en el pedido si es derecha o izquierda. (Ver página 124).



Tipo N

### Bitubo y Monotubo. Modelos Verticales:

Válvula Mono-Bitubo de conexión inferior con entre ejes de 50 mm.

Instalaciones Bitubo; *bypass* cerrado.  
Instalaciones Monotubo; *bypass* abierto.

Como estándar se suministra el tipo P (entrada por la derecha). El tipo Q bajo pedido.

La entrada derecha-izquierda no es relevante si la válvula no es termostática.



Tipo P



Tipo Q

Tipo de válvula	Acabado	Regulación manual PVP €	Regulación termostática PVP €
Todos los tipos de válvulas	Todos los acabados	<b>202,59</b>	<b>268,14</b>

# Zehnder Excelsior





# Zehnder Excelsior

## ESPECIFICACIONES TÉCNICAS

### Modelos 1000. Simples

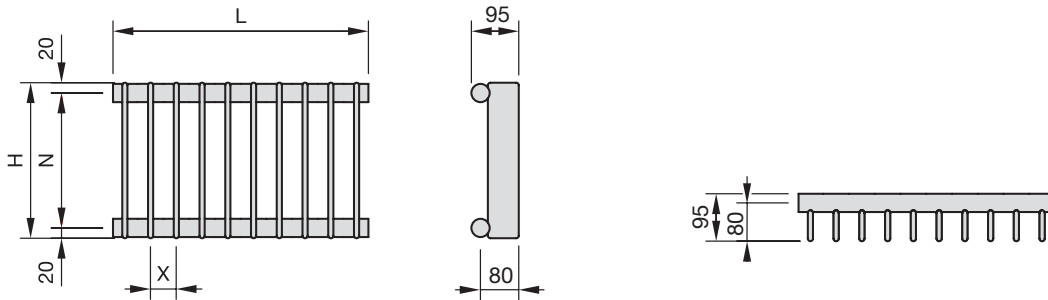

### Modelos 2000. Dobles

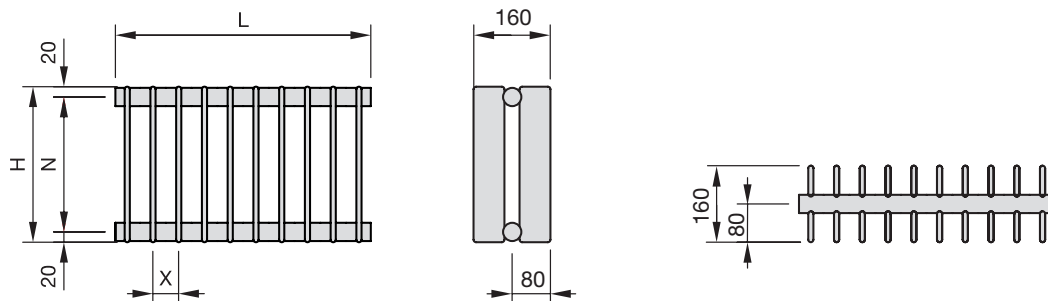

- Tubos planos 70 x 8 x 1,45 mm.
- Colector de tubo redondo con diámetro 30 x 2 mm.
- Presión máxima de trabajo 4,6 bar. Presión de prueba en fábrica 6 bar.
- Paso X por elemento: 30, 40 y 50 mm. (60 mm bajo pedido).
- El Paso X es la distancia entre elementos (tubos) verticales. El precio es el mismo, pero a mayor distancia entre elementos tenemos más potencia pero también más longitud del radiador.
- A partir de 1800 mm de altura, el radiador lleva una barra horizontal soldada a la parte trasera de los elementos para asegurar su estabilidad.

L = Longitud. H = Altura. N = Distancia entre ejes. X = Distancia entre elementos.

# Zehnder Excelsior

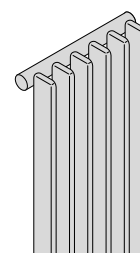
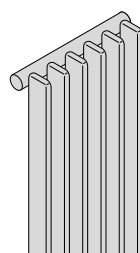
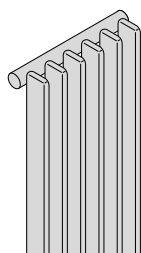
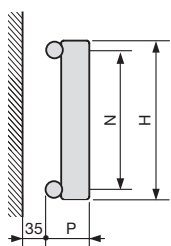

MODELO	E 1040/30	E 1040/40	E 1040/50
Altura H	400 mm	400 mm	400 mm
Entre ejes N	360 mm	360 mm	360 mm
Profundidad P	95 mm	95 mm	95 mm
Distancia entre elementos X	30 mm	40 mm	50 mm
Exponente n	1,26	1,26	1,26

Recuerde pedir el Pack de Conexión

Nº de elementos	Blanco RAL 9016 PVP €	Emisión EN 442 75/65/20 ΔT 50K W	Emisión Caldera condens. ΔT 40K W	Emisión Bomba de calor ΔT 32,5K W	Long. L mm	Emisión EN 442 75/65/20 ΔT 50K W	Emisión Caldera condens. ΔT 40K W	Emisión Bomba de calor ΔT 32,5K W	Long. L mm	Emisión EN 442 75/65/20 ΔT 50K W	Emisión Caldera condens. ΔT 40K W	Emisión Bomba de calor ΔT 32,5K W	Long. L mm
4	232,23	108	82	63	130	118	89	68	160	126	95	73	190
5	246,12	135	102	78	160	147	111	85	200	157	119	91	240
6	260,01	162	122	94	190	176	133	103	240	188	142	109	290
7	273,90	189	143	110	220	206	155	120	280	220	166	128	340
8	287,79	216	163	126	250	235	178	137	320	251	190	146	390
9	301,68	243	183	141	280	265	200	154	360	283	213	164	440
10	315,57	270	204	157	310	294	222	171	400	314	237	182	490
11	329,46	297	224	173	340	323	244	188	440	345	261	201	540
12	343,35	324	245	188	370	353	266	205	480	377	284	219	590
13	357,24	351	265	204	400	382	289	222	520	408	308	237	640
14	371,13	378	285	220	430	412	311	239	560	440	332	255	690
15	385,02	405	306	235	460	441	333	256	600	471	356	274	740
16	398,91	432	326	251	490	470	355	273	640	502	379	292	790
17	412,80	459	347	267	520	500	377	290	680	534	403	310	840
18	426,69	486	367	282	550	529	399	308	720	565	427	328	890
19	440,58	513	387	298	580	559	422	325	760	597	450	347	940
20	454,47	540	408	314	610	588	444	342	800	628	474	365	990
21	468,36	567	428	329	640	617	466	359	840	659	498	383	1.040
22	482,25	594	448	345	670	647	488	376	880	691	521	401	1.090
23	496,14	621	469	361	700	676	510	393	920	722	545	420	1.140
24	510,03	648	489	377	730	706	533	410	960	754	569	438	1.190
25	523,92	675	510	392	760	735	555	427	1.000	785	593	456	1.240
26	537,81	702	530	408	790	764	577	444	1.040	816	616	474	1.290
27	551,70	729	550	424	820	794	599	461	1.080	848	640	493	1.340
28	565,59	756	571	439	850	823	621	478	1.120	879	664	511	1.390
29	579,48	783	591	455	880	853	644	495	1.160	911	687	529	1.440
30	593,37	810	611	471	910	882	666	513	1.200	942	711	547	1.490
31	607,26	837	632	486	940	911	688	530	1.240	973	735	566	1.540
32	621,15	864	652	502	970	941	710	547	1.280	1.005	759	584	1.590
33	635,04	891	673	518	1.000	970	732	564	1.320	1.036	782	602	1.640
34	648,93	918	693	533	1.030	1.000	755	581	1.360	1.068	806	620	1.690
35	662,82	945	713	549	1.060	1.029	777	598	1.400	1.099	830	639	1.740
36	676,71	972	734	565	1.090	1.058	799	615	1.440	1.130	853	657	1.790
37	690,60	999	754	581	1.120	1.088	821	632	1.480	1.162	877	675	1.840
38	704,49	1.026	775	596	1.150	1.117	843	649	1.520	1.193	901	693	1.890
39	718,38	1.053	795	612	1.180	1.147	866	666	1.560	1.225	924	712	1.940
40	732,27	1.080	815	628	1.210	1.176	888	683	1.600	1.256	948	730	1.990

Precios para color blanco estándar RAL 9016.  
Precios para carta de colores Zehnder +25%. Otros colores, consultar.



# Zehnder Excelsior

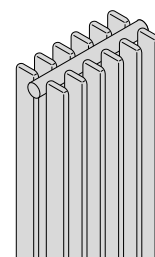
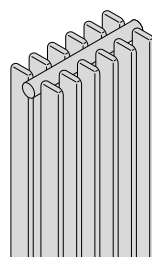
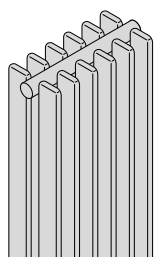
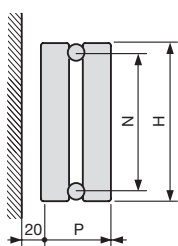

MODELO	E 2040/30	E 2040/40	E 2040/50
Altura H	400 mm	400 mm	400 mm
Entre ejes N	360 mm	360 mm	360 mm
Profundidad P	160 mm	160 mm	160 mm
Distancia entre elementos X	30 mm	40 mm	50 mm
Exponente n	1,27	1,27	1,27

Recuerde pedir el Pack de Conexión

Nº de elementos	Blanco RAL 9016 PVP €	Emisión EN 442 75/65/20 ΔT 50K W	Emisión Caldera condens. ΔT 40K W	Emisión Bomba de calor ΔT 32,5K W	Long. L mm	Emisión EN 442 75/65/20 ΔT 50K W	Emisión Caldera condens. ΔT 40K W	Emisión Bomba de calor ΔT 32,5K W	Long. L mm	Emisión EN 442 75/65/20 ΔT 50K W	Emisión Caldera condens. ΔT 40K W	Emisión Bomba de calor ΔT 32,5K W	Long. L mm
4	382,73	192	145	111	130	207	156	120	160	219	165	127	190
5	409,79	240	181	139	160	259	195	150	200	274	206	158	240
6	436,85	288	217	167	190	310	234	179	240	328	247	190	290
7	463,91	336	253	194	220	362	273	209	280	383	288	222	340
8	490,97	384	289	222	250	414	312	239	320	438	330	253	390
9	518,03	432	325	250	280	465	350	269	360	492	371	285	440
10	545,09	480	362	278	310	517	389	299	400	547	412	317	490
11	572,15	528	398	306	340	569	428	329	440	602	453	348	540
12	599,21	576	434	333	370	620	467	359	480	656	494	380	590
13	626,27	624	470	361	400	672	506	389	520	711	536	411	640
14	653,33	672	506	389	430	724	545	419	560	766	577	443	690
15	680,39	720	542	417	460	776	584	449	600	821	618	475	740
16	707,45	768	578	444	490	827	623	479	640	875	659	506	790
17	734,51	816	615	472	520	879	662	509	680	930	700	538	840
18	761,57	864	651	500	550	931	701	538	720	985	742	570	890
19	788,63	912	687	528	580	982	740	568	760	1.039	783	601	940
20	815,69	960	723	555	610	1.034	779	598	800	1.094	824	633	990
21	842,75	1.008	759	583	640	1.086	818	628	840	1.149	865	665	1.040
22	869,81	1.056	795	611	670	1.137	857	658	880	1.203	906	696	1.090
23	896,87	1.104	832	639	700	1.189	896	688	920	1.258	948	728	1.140
24	923,93	1.152	868	667	730	1.241	935	718	960	1.313	989	760	1.190
25	950,99	1.200	904	694	760	1.293	974	748	1.000	1.368	1.030	791	1.240
26	978,05	1.248	940	722	790	1.344	1.012	778	1.040	1.422	1.071	823	1.290
27	1.005,11	1.296	976	750	820	1.396	1.051	808	1.080	1.477	1.112	855	1.340
28	1.032,17	1.344	1.012	778	850	1.448	1.090	838	1.120	1.532	1.154	886	1.390
29	1.059,23	1.392	1.048	805	880	1.499	1.129	868	1.160	1.586	1.195	918	1.440
30	1.086,29	1.440	1.085	833	910	1.551	1.168	897	1.200	1.641	1.236	950	1.490
31	1.113,35	1.488	1.121	861	940	1.603	1.207	927	1.240	1.696	1.277	981	1.540
32	1.140,41	1.536	1.157	889	970	1.654	1.246	957	1.280	1.750	1.318	1.013	1.590
33	1.167,47	1.584	1.193	917	1.000	1.706	1.285	987	1.320	1.805	1.360	1.044	1.640
34	1.194,53	1.632	1.229	944	1.030	1.758	1.324	1.017	1.360	1.860	1.401	1.076	1.690
35	1.221,59	1.680	1.265	972	1.060	1.810	1.363	1.047	1.400	1.915	1.442	1.108	1.740
36	1.248,65	1.728	1.302	1.000	1.090	1.861	1.402	1.077	1.440	1.969	1.483	1.139	1.790
37	1.275,71	1.776	1.338	1.028	1.120	1.913	1.441	1.107	1.480	2.024	1.524	1.171	1.840
38	1.302,77	1.824	1.374	1.055	1.150	1.965	1.480	1.137	1.520	2.079	1.566	1.203	1.890
39	1.329,83	1.872	1.410	1.083	1.180	2.016	1.519	1.167	1.560	2.133	1.607	1.234	1.940
40	1.356,89	1.920	1.446	1.111	1.210	2.068	1.558	1.197	1.600	2.188	1.648	1.266	1.990

Precios para color blanco estándar RAL 9016.

Precios para carta de colores Zehnder +25%. Otros colores, consultar.



# Zehnder Excelsior

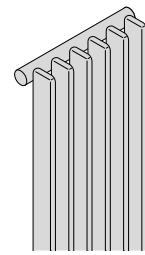
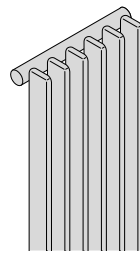
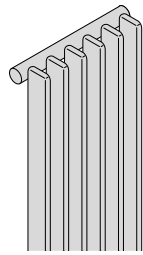
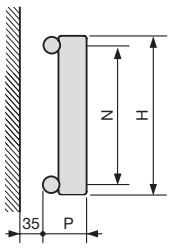

MODELO	E 1050/30	E 1050/40	E 1050/50
Altura H	500 mm	500 mm	500 mm
Entre ejes N	460 mm	460 mm	460 mm
Profundidad P	95 mm	95 mm	95 mm
Distancia entre elementos X	30 mm	40 mm	50 mm
Exponente n	1,25	1,25	1,25

Recuerde pedir el Pack de Conexión

Nº de elementos	Blanco RAL 9016 PVP €	Emisión EN 442 75/65/20			Long. L mm	Emisión Caldera condens. ΔT 40K			Long. L mm	Emisión Bomba de calor ΔT 32,5K			Long. L mm
		ΔT 50K W	ΔT 40K W	ΔT 32,5K W		ΔT 50K W	ΔT 40K W	ΔT 32,5K W		ΔT 50K W	ΔT 40K W	ΔT 32,5K W	
4	239,22	128	97	74	130	138	104	80	160	147	111	86	190
5	254,86	160	121	93	160	172	130	100	200	184	139	107	240
6	270,50	191	145	112	190	206	156	120	240	221	167	129	290
7	286,14	223	169	130	220	241	182	141	280	258	195	150	340
8	301,78	255	193	149	250	275	208	161	320	294	223	172	390
9	317,42	287	217	168	280	310	234	181	360	331	251	193	440
10	333,06	319	241	186	310	344	260	201	400	368	278	215	490
11	348,70	351	265	205	340	378	286	221	440	405	306	236	540
12	364,34	383	290	223	370	413	312	241	480	442	334	258	590
13	379,98	415	314	242	400	447	338	261	520	478	362	279	640
14	395,62	447	338	261	430	482	364	281	560	515	390	301	690
15	411,26	479	362	279	460	516	390	301	600	552	418	322	740
16	426,90	510	386	298	490	550	416	321	640	589	445	344	790
17	442,54	542	410	317	520	585	442	341	680	626	473	365	840
18	458,18	574	434	335	550	619	468	361	720	662	501	387	890
19	473,82	606	459	354	580	654	495	381	760	699	529	408	940
20	489,46	638	483	372	610	688	521	402	800	736	557	430	990
21	505,10	670	507	391	640	722	547	422	840	773	585	451	1.040
22	520,74	702	531	410	670	757	573	442	880	810	613	473	1.090
23	536,38	734	555	428	700	791	599	462	920	846	640	494	1.140
24	552,02	766	579	447	730	826	625	482	960	883	668	515	1.190
25	567,66	798	603	465	760	860	651	502	1.000	920	696	537	1.240
26	583,30	829	628	484	790	894	677	522	1.040	957	724	558	1.290
27	598,94	861	652	503	820	929	703	542	1.080	994	752	580	1.340
28	614,58	893	676	521	850	963	729	562	1.120	1.030	780	601	1.390
29	630,22	925	700	540	880	998	755	582	1.160	1.067	807	623	1.440
30	645,86	957	724	559	910	1.032	781	602	1.200	1.104	835	644	1.490
31	661,50	989	748	577	940	1.066	807	622	1.240	1.141	863	666	1.540
32	677,14	1.021	772	596	970	1.101	833	642	1.280	1.178	891	687	1.590
33	692,78	1.053	796	614	1.000	1.135	859	663	1.320	1.214	919	709	1.640
34	708,42	1.085	821	633	1.030	1.170	885	683	1.360	1.251	947	730	1.690
35	724,06	1.117	845	652	1.060	1.204	911	703	1.400	1.288	974	752	1.740
36	739,70	1.148	869	670	1.090	1.238	937	723	1.440	1.325	1.002	773	1.790
37	755,34	1.180	893	689	1.120	1.273	963	743	1.480	1.362	1.030	795	1.840
38	770,98	1.212	917	707	1.150	1.307	989	763	1.520	1.398	1.058	816	1.890
39	786,62	1.244	941	726	1.180	1.342	1.015	783	1.560	1.435	1.086	838	1.940
40	802,26	1.276	965	745	1.210	1.376	1.041	803	1.600	1.472	1.114	859	1.990

Precios para color blanco estándar RAL 9016.  
Precios para carta de colores Zehnder +25%. Otros colores, consultar.



# Zehnder Excelsior

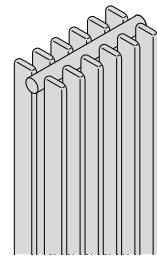
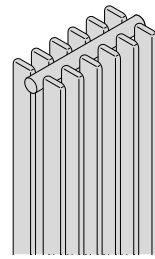
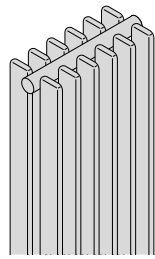
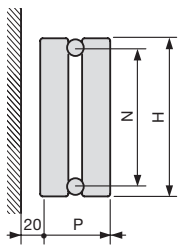

MODELO	E 2050/30	E 2050/40	E 2050/50
Altura H	500 mm	500 mm	500 mm
Entre ejes N	460 mm	460 mm	460 mm
Profundidad P	160 mm	160 mm	160 mm
Distancia entre elementos X	30 mm	40 mm	50 mm
Exponente n	1,25	1,25	1,25

Recuerde pedir el Pack de Conexión

Nº de elementos	Blanco RAL 9016 PVP €	Emisión EN 442 75/65/20 ΔT 50K W	Emisión Caldera condens. ΔT 40K W	Emisión Bomba de calor ΔT 32,5K W	Long. L mm	Emisión EN 442 75/65/20 ΔT 50K W	Emisión Caldera condens. ΔT 40K W	Emisión Bomba de calor ΔT 32,5K W	Long. L mm	Emisión EN 442 75/65/20 ΔT 50K W	Emisión Caldera condens. ΔT 40K W	Emisión Bomba de calor ΔT 32,5K W	Long. L mm
4	397,97	226	171	132	130	244	185	143	160	262	198	153	190
5	428,84	283	214	165	160	306	231	178	200	328	248	191	240
6	459,71	339	256	198	190	367	277	214	240	393	297	229	290
7	490,58	396	299	231	220	428	324	250	280	459	347	268	340
8	521,45	452	342	264	250	489	370	285	320	524	396	306	390
9	552,32	509	385	297	280	550	416	321	360	590	446	344	440
10	583,19	565	427	330	310	611	462	357	400	655	496	382	490
11	614,06	622	470	363	340	672	509	392	440	721	545	421	540
12	644,93	678	513	396	370	733	555	428	480	786	595	459	590
13	675,80	735	556	429	400	794	601	464	520	852	644	497	640
14	706,67	791	598	462	430	855	647	499	560	917	694	535	690
15	737,54	848	641	495	460	917	693	535	600	983	743	573	740
16	768,41	904	684	528	490	978	740	571	640	1.048	793	612	790
17	799,28	961	727	561	520	1.039	786	606	680	1.114	842	650	840
18	830,15	1.017	769	594	550	1.100	832	642	720	1.179	892	688	890
19	861,02	1.074	812	627	580	1.161	878	678	760	1.245	942	726	940
20	891,89	1.130	855	660	610	1.222	925	713	800	1.310	991	765	990
21	922,76	1.187	898	692	640	1.283	971	749	840	1.376	1.041	803	1.040
22	953,63	1.243	940	725	670	1.344	1.017	785	880	1.441	1.090	841	1.090
23	984,50	1.300	983	758	700	1.405	1.063	820	920	1.507	1.140	879	1.140
24	1.015,37	1.356	1.026	791	730	1.466	1.109	856	960	1.572	1.189	917	1.190
25	1.046,24	1.413	1.069	824	760	1.528	1.156	892	1.000	1.638	1.239	956	1.240
26	1.077,11	1.469	1.111	857	790	1.589	1.202	927	1.040	1.703	1.288	994	1.290
27	1.107,98	1.526	1.154	890	820	1.650	1.248	963	1.080	1.769	1.338	1.032	1.340
28	1.138,85	1.582	1.197	923	850	1.711	1.294	998	1.120	1.834	1.388	1.070	1.390
29	1.169,72	1.639	1.240	956	880	1.772	1.341	1.034	1.160	1.900	1.437	1.109	1.440
30	1.200,59	1.695	1.282	989	910	1.833	1.387	1.070	1.200	1.965	1.487	1.147	1.490
31	1.231,46	1.752	1.325	1.022	940	1.894	1.433	1.105	1.240	2.031	1.536	1.185	1.540
32	1.262,33	1.808	1.368	1.055	970	1.955	1.479	1.141	1.280	2.096	1.586	1.223	1.590
33	1.293,20	1.865	1.411	1.088	1.000	2.016	1.526	1.177	1.320	2.162	1.635	1.262	1.640
34	1.324,07	1.921	1.453	1.121	1.030	2.077	1.572	1.212	1.360	2.227	1.685	1.300	1.690
35	1.354,94	1.978	1.496	1.154	1.060	2.139	1.618	1.248	1.400	2.293	1.734	1.338	1.740
36	1.385,81	2.034	1.539	1.187	1.090	2.200	1.664	1.284	1.440	2.358	1.784	1.376	1.790
37	1.416,68	2.091	1.582	1.220	1.120	2.261	1.710	1.319	1.480	2.424	1.834	1.414	1.840
38	1.447,55	2.147	1.624	1.253	1.150	2.322	1.757	1.355	1.520	2.489	1.883	1.453	1.890
39	1.478,42	2.204	1.667	1.286	1.180	2.383	1.803	1.391	1.560	2.555	1.933	1.491	1.940
40	1.509,29	2.260	1.710	1.319	1.210	2.444	1.849	1.426	1.600	2.620	1.982	1.529	1.990

Precios para color blanco estándar RAL 9016.

Precios para carta de colores Zehnder +25%. Otros colores, consultar.



# Zehnder Excelsior

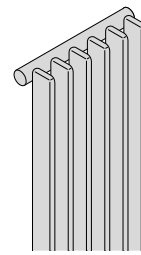
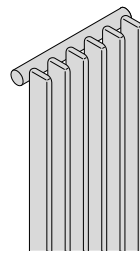
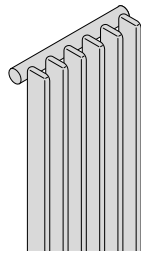
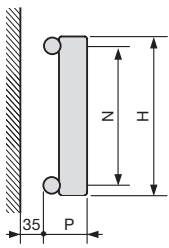

MODELO	E 1060/30	E 1060/40	E 1060/50
Altura H	600 mm	600 mm	600 mm
Entre ejes N	560 mm	560 mm	560 mm
Profundidad P	95 mm	95 mm	95 mm
Distancia entre elementos X	30 mm	40 mm	50 mm
Exponente n	1,26	1,26	1,26

Recuerde pedir el Pack de Conexión

Nº de elementos	Blanco RAL 9016 PVP €	Emisión EN 442 75/65/20 ΔT 50K W	Emisión Caldera condens. ΔT 40K W	Emisión Bomba de calor ΔT 32,5K W	Long. L mm	Emisión EN 442 75/65/20 ΔT 50K W	Emisión Caldera condens. ΔT 40K W	Emisión Bomba de calor ΔT 32,5K W	Long. L mm	Emisión EN 442 75/65/20 ΔT 50K W	Emisión Caldera condens. ΔT 40K W	Emisión Bomba de calor ΔT 32,5K W	Long. L mm
4	233,96	148	111	86	130	159	120	92	160	169	128	98	190
5	251,58	185	139	107	160	199	150	115	200	212	160	123	240
6	269,20	221	167	129	190	238	180	138	240	254	192	147	290
7	286,82	258	195	150	220	278	210	161	280	296	224	172	340
8	304,44	295	223	172	250	318	240	185	320	338	255	197	390
9	322,06	332	251	193	280	357	270	208	360	381	287	221	440
10	339,68	369	279	214	310	397	300	231	400	423	319	246	490
11	357,30	406	306	236	340	437	330	254	440	465	351	270	540
12	374,92	443	334	257	370	476	360	277	480	508	383	295	590
13	392,54	480	362	279	400	516	390	300	520	550	415	320	640
14	410,16	517	390	300	430	556	420	323	560	592	447	344	690
15	427,78	554	418	322	460	596	450	346	600	635	479	369	740
16	445,40	590	446	343	490	635	480	369	640	677	511	393	790
17	463,02	627	474	365	520	675	509	392	680	719	543	418	840
18	480,64	664	501	386	550	715	539	415	720	761	575	442	890
19	498,26	701	529	407	580	754	569	438	760	804	607	467	940
20	515,88	738	557	429	610	794	599	461	800	846	639	492	990
21	533,50	775	585	450	640	834	629	484	840	888	671	516	1.040
22	551,12	812	613	472	670	873	659	508	880	931	703	541	1.090
23	568,74	849	641	493	700	913	689	531	920	973	734	565	1.140
24	586,36	886	669	515	730	953	719	554	960	1.015	766	590	1.190
25	603,98	923	696	536	760	993	749	577	1.000	1.058	798	615	1.240
26	621,60	959	724	558	790	1.032	779	600	1.040	1.100	830	639	1.290
27	639,22	996	752	579	820	1.072	809	623	1.080	1.142	862	664	1.340
28	656,84	1.033	780	600	850	1.112	839	646	1.120	1.184	894	688	1.390
29	674,46	1.070	808	622	880	1.151	869	669	1.160	1.227	926	713	1.440
30	692,08	1.107	836	643	910	1.191	899	692	1.200	1.269	958	737	1.490
31	709,70	1.144	864	665	940	1.231	929	715	1.240	1.311	990	762	1.540
32	727,32	1.181	891	686	970	1.270	959	738	1.280	1.354	1.022	787	1.590
33	744,94	1.218	919	708	1.000	1.310	989	761	1.320	1.396	1.054	811	1.640
34	762,56	1.255	947	729	1.030	1.350	1.019	784	1.360	1.438	1.086	836	1.690
35	780,18	1.292	975	751	1.060	1.390	1.049	807	1.400	1.481	1.118	860	1.740
36	797,80	1.328	1.003	772	1.090	1.429	1.079	831	1.440	1.523	1.150	885	1.790
37	815,42	1.365	1.031	793	1.120	1.469	1.109	854	1.480	1.565	1.182	910	1.840
38	833,04	1.402	1.059	815	1.150	1.509	1.139	877	1.520	1.607	1.213	934	1.890
39	850,66	1.439	1.086	836	1.180	1.548	1.169	900	1.560	1.650	1.245	959	1.940
40	868,28	1.476	1.114	858	1.210	1.588	1.199	923	1.600	1.692	1.277	983	1.990

Precios para color blanco estándar RAL 9016.

Precios para carta de colores Zehnder +25%. Otros colores, consultar.



# Zehnder Excelsior

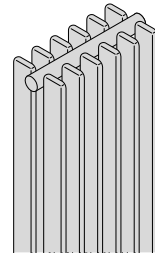
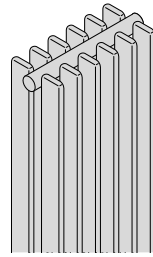
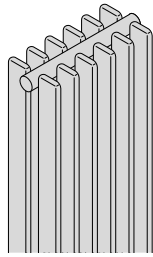
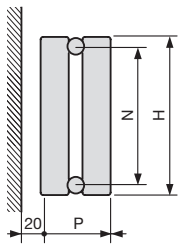

MODELO	E 2060/30	E 2060/40	E 2060/50
Altura H	600 mm	600 mm	600 mm
Entre ejes N	560 mm	560 mm	560 mm
Profundidad P	160 mm	160 mm	160 mm
Distancia entre elementos X	30 mm	40 mm	50 mm
Exponente n	1,28	1,28	1,28

Recuerde pedir el Pack de Conexión

Nº de elementos	Blanco RAL 9016 PVP €	Emisión EN 442 75/65/20			Long. L mm	Emisión Caldera condens. ΔT 40K W			Long. L mm	Emisión Bomba de calor ΔT 32,5K W			Long. L mm
		ΔT 50K W	ΔT 40K W	ΔT 32,5K W		ΔT 50K W	ΔT 40K W	ΔT 32,5K W		ΔT 50K W	ΔT 40K W	ΔT 32,5K W	
4	404,65	261	196	150	130	282	212	163	160	307	231	177	190
5	440,48	326	245	188	160	353	265	203	200	384	288	221	240
6	476,31	391	294	225	190	424	318	244	240	460	346	265	290
7	512,14	456	343	263	220	494	371	285	280	537	404	309	340
8	547,97	522	392	301	250	565	424	325	320	614	461	354	390
9	583,80	587	441	338	280	635	478	366	360	690	519	398	440
10	619,63	652	490	376	310	706	531	407	400	767	576	442	490
11	655,46	717	539	413	340	777	584	447	440	844	634	486	540
12	691,29	782	588	451	370	847	637	488	480	920	692	530	590
13	727,12	848	637	488	400	918	690	529	520	997	749	574	640
14	762,95	913	686	526	430	988	743	569	560	1.074	807	619	690
15	798,78	978	735	563	460	1.059	796	610	600	1.151	865	663	740
16	834,61	1.043	784	601	490	1.130	849	651	640	1.227	922	707	790
17	870,44	1.108	833	639	520	1.200	902	691	680	1.304	980	751	840
18	906,27	1.174	882	676	550	1.271	955	732	720	1.381	1.038	795	890
19	942,10	1.239	931	714	580	1.341	1.008	773	760	1.457	1.095	840	940
20	977,93	1.304	980	751	610	1.412	1.061	814	800	1.534	1.153	884	990
21	1.013,76	1.369	1.029	789	640	1.483	1.114	854	840	1.611	1.211	928	1.040
22	1.049,59	1.434	1.078	826	670	1.553	1.167	895	880	1.687	1.268	972	1.090
23	1.085,42	1.500	1.127	864	700	1.624	1.220	936	920	1.764	1.326	1.016	1.140
24	1.121,25	1.565	1.176	902	730	1.694	1.273	976	960	1.841	1.383	1.061	1.190
25	1.157,08	1.630	1.225	939	760	1.765	1.326	1.017	1.000	1.918	1.441	1.105	1.240
26	1.192,91	1.695	1.274	977	790	1.836	1.380	1.058	1.040	1.994	1.499	1.149	1.290
27	1.228,74	1.760	1.323	1.014	820	1.906	1.433	1.098	1.080	2.071	1.556	1.193	1.340
28	1.264,57	1.826	1.372	1.052	850	1.977	1.486	1.139	1.120	2.148	1.614	1.237	1.390
29	1.300,40	1.891	1.421	1.089	880	2.047	1.539	1.180	1.160	2.224	1.672	1.282	1.440
30	1.336,23	1.956	1.470	1.127	910	2.118	1.592	1.220	1.200	2.301	1.729	1.326	1.490
31	1.372,06	2.021	1.519	1.164	940	2.189	1.645	1.261	1.240	2.378	1.787	1.370	1.540
32	1.407,89	2.086	1.568	1.202	970	2.259	1.698	1.302	1.280	2.454	1.845	1.414	1.590
33	1.443,72	2.152	1.617	1.240	1.000	2.330	1.751	1.342	1.320	2.531	1.902	1.458	1.640
34	1.479,55	2.217	1.666	1.277	1.030	2.400	1.804	1.383	1.360	2.608	1.960	1.502	1.690
35	1.515,38	2.282	1.715	1.315	1.060	2.471	1.857	1.424	1.400	2.685	2.018	1.547	1.740
36	1.551,21	2.347	1.764	1.352	1.090	2.542	1.910	1.464	1.440	2.761	2.075	1.591	1.790
37	1.587,04	2.412	1.813	1.390	1.120	2.612	1.963	1.505	1.480	2.838	2.133	1.635	1.840
38	1.622,87	2.478	1.862	1.427	1.150	2.683	2.016	1.546	1.520	2.915	2.190	1.679	1.890
39	1.658,70	2.543	1.911	1.465	1.180	2.753	2.069	1.586	1.560	2.991	2.248	1.723	1.940
40	1.694,53	2.608	1.960	1.503	1.210	2.824	2.122	1.627	1.600	3.068	2.306	1.768	1.990

Precios para color blanco estándar RAL 9016.  
Precios para carta de colores Zehnder +25%. Otros colores, consultar.



# Zehnder Excelsior

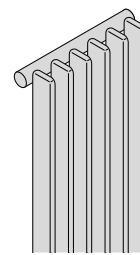
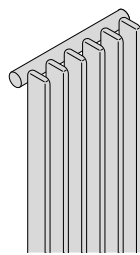
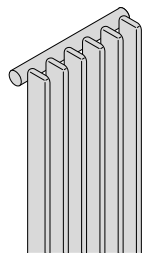
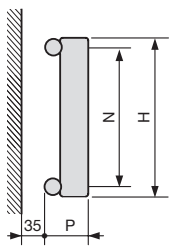

MODELO	E 1070/30	E 1070/40	E 1070/50
Altura H	700 mm	700 mm	700 mm
Entre ejes N	660 mm	660 mm	660 mm
Profundidad P	95 mm	95 mm	95 mm
Distancia entre elementos X	30 mm	40 mm	50 mm
Exponente n	1,27	1,27	1,27

Recuerde pedir el Pack de Conexión

Nº de elementos	Blanco RAL 9016 PVP €	Emisión EN 442 75/65/20 ΔT 50K W	Emisión Caldera condens. ΔT 40K W	Emisión Bomba de calor ΔT 32,5K W	Long. L mm	Emisión EN 442 75/65/20 ΔT 50K W	Emisión Caldera condens. ΔT 40K W	Emisión Bomba de calor ΔT 32,5K W	Long. L mm	Emisión EN 442 75/65/20 ΔT 50K W	Emisión Caldera condens. ΔT 40K W	Emisión Bomba de calor ΔT 32,5K W	Long. L mm
4	254,66	168	126	97	130	180	136	104	160	192	144	111	190
5	274,16	210	158	121	160	225	169	130	200	240	180	139	240
6	293,66	251	189	145	190	270	203	156	240	287	216	166	290
7	313,16	293	221	170	220	315	237	182	280	335	253	194	340
8	332,66	335	252	194	250	360	271	208	320	383	289	222	390
9	352,16	377	284	218	280	405	305	234	360	431	325	249	440
10	371,66	419	316	242	310	450	339	260	400	479	361	277	490
11	391,16	461	347	267	340	495	373	286	440	527	397	305	540
12	410,66	503	379	291	370	540	407	312	480	575	433	333	590
13	430,16	545	410	315	400	585	441	338	520	623	469	360	640
14	449,66	587	442	339	430	630	475	365	560	671	505	388	690
15	469,16	629	473	364	460	675	508	391	600	719	541	416	740
16	488,66	670	505	388	490	720	542	417	640	766	577	443	790
17	508,16	712	537	412	520	765	576	443	680	814	613	471	840
18	527,66	754	568	436	550	810	610	469	720	862	649	499	890
19	547,16	796	600	461	580	855	644	495	760	910	686	527	940
20	566,66	838	631	485	610	900	678	521	800	958	722	554	990
21	586,16	880	663	509	640	945	712	547	840	1.006	758	582	1.040
22	605,66	922	694	533	670	990	746	573	880	1.054	794	610	1.090
23	625,16	964	726	558	700	1.035	780	599	920	1.102	830	637	1.140
24	644,66	1.006	757	582	730	1.080	813	625	960	1.150	866	665	1.190
25	664,16	1.048	789	606	760	1.125	847	651	1.000	1.198	902	693	1.240
26	683,66	1.089	821	630	790	1.170	881	677	1.040	1.245	938	721	1.290
27	703,16	1.131	852	655	820	1.215	915	703	1.080	1.293	974	748	1.340
28	722,66	1.173	884	679	850	1.260	949	729	1.120	1.341	1.010	776	1.390
29	742,16	1.215	915	703	880	1.305	983	755	1.160	1.389	1.046	804	1.440
30	761,66	1.257	947	727	910	1.350	1.017	781	1.200	1.437	1.082	831	1.490
31	781,16	1.299	978	752	940	1.395	1.051	807	1.240	1.485	1.118	859	1.540
32	800,66	1.341	1.010	776	970	1.440	1.085	833	1.280	1.533	1.155	887	1.590
33	820,16	1.383	1.041	800	1.000	1.485	1.119	859	1.320	1.581	1.191	915	1.640
34	839,66	1.425	1.073	824	1.030	1.530	1.152	885	1.360	1.629	1.227	942	1.690
35	859,16	1.467	1.105	849	1.060	1.575	1.186	911	1.400	1.677	1.263	970	1.740
36	878,66	1.508	1.136	873	1.090	1.620	1.220	937	1.440	1.724	1.299	998	1.790
37	898,16	1.550	1.168	897	1.120	1.665	1.254	963	1.480	1.772	1.335	1.026	1.840
38	917,66	1.592	1.199	921	1.150	1.710	1.288	989	1.520	1.820	1.371	1.053	1.890
39	937,16	1.634	1.231	946	1.180	1.755	1.322	1.015	1.560	1.868	1.407	1.081	1.940
40	956,66	1.676	1.262	970	1.210	1.800	1.356	1.042	1.600	1.916	1.443	1.109	1.990

Precios para color blanco estándar RAL 9016.

Precios para carta de colores Zehnder +25%. Otros colores, consultar.





# Zehnder Excelsior

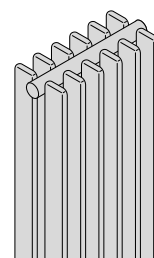
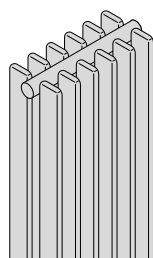
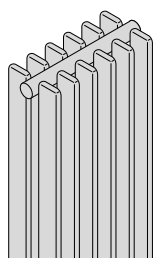
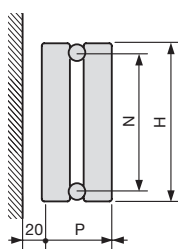

MODELO	E 2070/30	E 2070/40	E 2070/50
Altura H	700 mm	700 mm	700 mm
Entre ejes N	660 mm	660 mm	660 mm
Profundidad P	160 mm	160 mm	160 mm
Distancia entre elementos X	30 mm	40 mm	50 mm
Exponente n	1,29	1,29	1,29

Recuerde pedir el Pack de Conexión

Nº de elementos	Blanco RAL 9016 PVP €	Emisión			Long. L mm	Emisión			Long. L mm	Emisión			Long. L mm
		EN 442 75/65/20 ΔT 50K W	Caldera condens. ΔT 40K W	Bomba de calor ΔT 32,5K W		EN 442 75/65/20 ΔT 50K W	Caldera condens. ΔT 40K W	Bomba de calor ΔT 32,5K W		EN 442 75/65/20 ΔT 50K W	Caldera condens. ΔT 40K W	Bomba de calor ΔT 32,5K W	
4	431,57	295	221	169	130	320	240	184	160	350	263	201	190
5	470,84	369	276	211	160	401	300	230	200	438	328	251	240
6	510,11	442	332	254	190	481	360	276	240	526	394	302	290
7	549,38	516	387	296	220	561	420	322	280	613	460	352	340
8	588,65	590	442	338	250	641	481	368	320	701	526	402	390
9	627,92	663	497	381	280	721	541	414	360	788	591	452	440
10	667,19	737	553	423	310	801	601	460	400	876	657	503	490
11	706,46	811	608	465	340	881	661	505	440	964	723	553	540
12	745,73	884	663	507	370	961	721	551	480	1.051	788	603	590
13	785,00	958	718	550	400	1.041	781	597	520	1.139	854	653	640
14	824,27	1.032	774	592	430	1.121	841	643	560	1.226	920	704	690
15	863,54	1.106	829	634	460	1.202	901	689	600	1.314	985	754	740
16	902,81	1.179	884	676	490	1.282	961	735	640	1.402	1.051	804	790
17	942,08	1.253	940	719	520	1.362	1.021	781	680	1.489	1.117	854	840
18	981,35	1.327	995	761	550	1.442	1.081	827	720	1.577	1.182	905	890
19	1.020,62	1.400	1.050	803	580	1.522	1.141	873	760	1.664	1.248	955	940
20	1.059,89	1.474	1.105	846	610	1.602	1.201	919	800	1.752	1.314	1.005	990
21	1.099,16	1.548	1.161	888	640	1.682	1.261	965	840	1.840	1.379	1.055	1.040
22	1.138,43	1.621	1.216	930	670	1.762	1.321	1.011	880	1.927	1.445	1.106	1.090
23	1.177,70	1.695	1.271	972	700	1.842	1.381	1.057	920	2.015	1.511	1.156	1.140
24	1.216,97	1.769	1.326	1.015	730	1.922	1.442	1.103	960	2.102	1.577	1.206	1.190
25	1.256,24	1.843	1.382	1.057	760	2.003	1.502	1.149	1.000	2.190	1.642	1.256	1.240
26	1.295,51	1.916	1.437	1.099	790	2.083	1.562	1.195	1.040	2.278	1.708	1.307	1.290
27	1.334,78	1.990	1.492	1.142	820	2.163	1.622	1.241	1.080	2.365	1.774	1.357	1.340
28	1.374,05	2.064	1.547	1.184	850	2.243	1.682	1.287	1.120	2.453	1.839	1.407	1.390
29	1.413,32	2.137	1.603	1.226	880	2.323	1.742	1.333	1.160	2.540	1.905	1.457	1.440
30	1.452,59	2.211	1.658	1.268	910	2.403	1.802	1.379	1.200	2.628	1.971	1.508	1.490
31	1.491,86	2.285	1.713	1.311	940	2.483	1.862	1.424	1.240	2.716	2.036	1.558	1.540
32	1.531,13	2.358	1.768	1.353	970	2.563	1.922	1.470	1.280	2.803	2.102	1.608	1.590
33	1.570,40	2.432	1.824	1.395	1.000	2.643	1.982	1.516	1.320	2.891	2.168	1.658	1.640
34	1.609,67	2.506	1.879	1.437	1.030	2.723	2.042	1.562	1.360	2.978	2.233	1.709	1.690
35	1.648,94	2.580	1.934	1.480	1.060	2.804	2.102	1.608	1.400	3.066	2.299	1.759	1.740
36	1.688,21	2.653	1.990	1.522	1.090	2.884	2.162	1.654	1.440	3.154	2.365	1.809	1.790
37	1.727,48	2.727	2.045	1.564	1.120	2.964	2.222	1.700	1.480	3.241	2.430	1.859	1.840
38	1.766,75	2.801	2.100	1.607	1.150	3.044	2.282	1.746	1.520	3.329	2.496	1.910	1.890
39	1.806,02	2.874	2.155	1.649	1.180	3.124	2.343	1.792	1.560	3.416	2.562	1.960	1.940
40	1.845,29	2.948	2.211	1.691	1.210	3.204	2.403	1.838	1.600	3.504	2.628	2.010	1.990

Precios para color blanco estándar RAL 9016.

Precios para carta de colores Zehnder +25%. Otros colores, consultar.



# Zehnder Excelsior

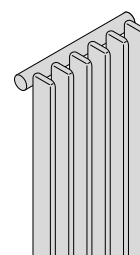
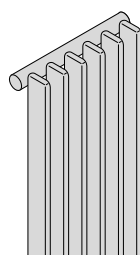
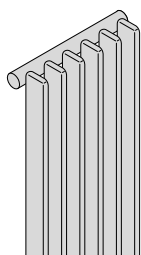
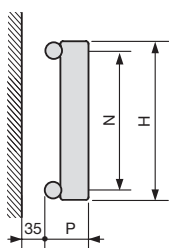

MODELO	E 1080/30	E 1080/40	E 1080/50
Altura H	800 mm	800 mm	800 mm
Entre ejes N	760 mm	760 mm	760 mm
Profundidad P	95 mm	95 mm	95 mm
Distancia entre elementos X	30 mm	40 mm	50 mm
Exponente n	1,28	1,28	1,28

Recuerde pedir el Pack de Conexión

Nº de elementos	Blanco RAL 9016 PVP €	Emisión EN 442 75/65/20			Long. mm	Emisión Caldera condens. ΔT 40K W			Long. mm	Emisión Bomba de calor ΔT 32,5K W			Long. mm
		ΔT 50K W	ΔT 40K W	ΔT 32,5K W		ΔT 50K W	ΔT 40K W	ΔT 32,5K W		ΔT 50K W	ΔT 40K W	ΔT 32,5K W	
4	264,66	187	141	108	130	201	151	116	160	214	161	123	190
5	286,66	234	176	135	160	252	189	145	200	268	201	154	240
6	308,66	281	211	162	190	302	227	174	240	321	241	185	290
7	330,66	328	246	189	220	352	265	203	280	375	281	216	340
8	352,66	374	281	216	250	402	302	232	320	428	322	247	390
9	374,66	421	317	243	280	453	340	261	360	482	362	277	440
10	396,66	468	352	270	310	503	378	290	400	535	402	308	490
11	418,66	515	387	297	340	553	416	319	440	589	442	339	540
12	440,66	562	422	324	370	604	454	348	480	642	482	370	590
13	462,66	608	457	351	400	654	491	377	520	696	523	401	640
14	484,66	655	492	377	430	704	529	406	560	749	563	432	690
15	506,66	702	528	404	460	755	567	435	600	803	603	462	740
16	528,66	749	563	431	490	805	605	464	640	856	643	493	790
17	550,66	796	598	458	520	855	643	493	680	910	684	524	840
18	572,66	842	633	485	550	905	680	522	720	963	724	555	890
19	594,66	889	668	512	580	956	718	551	760	1.017	764	586	940
20	616,66	936	703	539	610	1.006	756	580	800	1.070	804	616	990
21	638,66	983	739	566	640	1.056	794	609	840	1.124	844	647	1.040
22	660,66	1.030	774	593	670	1.107	832	638	880	1.177	885	678	1.090
23	682,66	1.076	809	620	700	1.157	869	667	920	1.231	925	709	1.140
24	704,66	1.123	844	647	730	1.207	907	696	960	1.284	965	740	1.190
25	726,66	1.170	879	674	760	1.258	945	724	1.000	1.338	1.005	771	1.240
26	748,66	1.217	914	701	790	1.308	983	753	1.040	1.391	1.045	801	1.290
27	770,66	1.264	950	728	820	1.358	1.021	782	1.080	1.445	1.086	832	1.340
28	792,66	1.310	985	755	850	1.408	1.058	811	1.120	1.498	1.126	863	1.390
29	814,66	1.357	1.020	782	880	1.459	1.096	840	1.160	1.552	1.166	894	1.440
30	836,66	1.404	1.055	809	910	1.509	1.134	869	1.200	1.605	1.206	925	1.490
31	858,66	1.451	1.090	836	940	1.559	1.172	898	1.240	1.659	1.246	956	1.540
32	880,66	1.498	1.126	863	970	1.610	1.210	927	1.280	1.712	1.287	986	1.590
33	902,66	1.544	1.161	890	1.000	1.660	1.247	956	1.320	1.766	1.327	1.017	1.640
34	924,66	1.591	1.196	917	1.030	1.710	1.285	985	1.360	1.819	1.367	1.048	1.690
35	946,66	1.638	1.231	944	1.060	1.761	1.323	1.014	1.400	1.873	1.407	1.079	1.740
36	968,66	1.685	1.266	971	1.090	1.811	1.361	1.043	1.440	1.926	1.447	1.110	1.790
37	990,66	1.732	1.301	998	1.120	1.861	1.399	1.072	1.480	1.980	1.488	1.140	1.840
38	1.012,66	1.778	1.337	1.025	1.150	1.911	1.437	1.101	1.520	2.033	1.528	1.171	1.890
39	1.034,66	1.825	1.372	1.052	1.180	1.962	1.474	1.130	1.560	2.087	1.568	1.202	1.940
40	1.056,66	1.872	1.407	1.079	1.210	2.012	1.512	1.159	1.600	2.140	1.608	1.233	1.990

Precios para color blanco estándar RAL 9016.  
Precios para carta de colores Zehnder +25%. Otros colores, consultar.



# Zehnder Excelsior

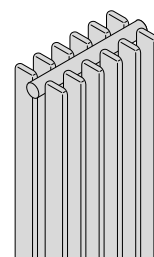
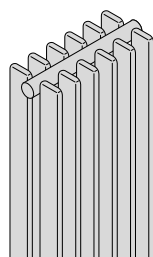
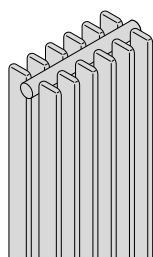
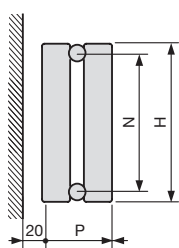

MODELO	E 2080/30	E 2080/40	E 2080/50
Altura H	800 mm	800 mm	800 mm
Entre ejes N	760 mm	760 mm	760 mm
Profundidad P	160 mm	160 mm	160 mm
Distancia entre elementos X	30 mm	40 mm	50 mm
Exponente n	1,30	1,30	1,30

Recuerde pedir el Pack de Conexión

Nº de elementos	Blanco RAL 9016 PVP €	E 2080/30				E 2080/40				E 2080/50			
		Emisión EN 442 75/65/20 ΔT 50K W	Emisión Caldera condens. ΔT 40K W	Emisión Bomba de calor ΔT 32,5K W	Long. L mm	Emisión EN 442 75/65/20 ΔT 50K W	Emisión Caldera condens. ΔT 40K W	Emisión Bomba de calor ΔT 32,5K W	Long. L mm	Emisión EN 442 75/65/20 ΔT 50K W	Emisión Caldera condens. ΔT 40K W	Emisión Bomba de calor ΔT 32,5K W	Long. L mm
4	448,44	328	246	188	130	358	268	204	160	394	294	225	190
5	491,93	411	307	234	160	447	334	255	200	492	368	281	240
6	535,42	493	369	281	190	536	401	306	240	590	442	337	290
7	578,91	575	430	328	220	626	468	357	280	689	515	393	340
8	622,40	657	491	375	250	715	535	409	320	787	589	450	390
9	665,89	739	553	422	280	805	602	460	360	886	663	506	440
10	709,38	821	614	469	310	894	669	511	400	984	736	562	490
11	752,87	903	676	516	340	983	736	562	440	1.082	810	618	540
12	796,36	985	737	563	370	1.073	803	613	480	1.181	883	674	590
13	839,85	1.067	799	610	400	1.162	870	664	520	1.279	957	731	640
14	883,34	1.149	860	657	430	1.252	936	715	560	1.378	1.031	787	690
15	926,83	1.232	921	703	460	1.341	1.003	766	600	1.476	1.104	843	740
16	970,32	1.314	983	750	490	1.430	1.070	817	640	1.574	1.178	899	790
17	1.013,81	1.396	1.044	797	520	1.520	1.137	868	680	1.673	1.252	956	840
18	1.057,30	1.478	1.106	844	550	1.609	1.204	919	720	1.771	1.325	1.012	890
19	1.100,79	1.560	1.167	891	580	1.699	1.271	970	760	1.870	1.399	1.068	940
20	1.144,28	1.642	1.229	938	610	1.788	1.338	1.021	800	1.968	1.472	1.124	990
21	1.187,77	1.724	1.290	985	640	1.877	1.405	1.072	840	2.066	1.546	1.180	1.040
22	1.231,26	1.806	1.351	1.032	670	1.967	1.472	1.123	880	2.165	1.620	1.237	1.090
23	1.274,75	1.888	1.413	1.079	700	2.056	1.538	1.174	920	2.263	1.693	1.293	1.140
24	1.318,24	1.970	1.474	1.125	730	2.146	1.605	1.226	960	2.362	1.767	1.349	1.190
25	1.361,73	2.053	1.536	1.172	760	2.235	1.672	1.277	1.000	2.460	1.841	1.405	1.240
26	1.405,22	2.135	1.597	1.219	790	2.324	1.739	1.328	1.040	2.558	1.914	1.461	1.290
27	1.448,71	2.217	1.659	1.266	820	2.414	1.806	1.379	1.080	2.657	1.988	1.518	1.340
28	1.492,20	2.299	1.720	1.313	850	2.503	1.873	1.430	1.120	2.755	2.061	1.574	1.390
29	1.535,69	2.381	1.781	1.360	880	2.593	1.940	1.481	1.160	2.854	2.135	1.630	1.440
30	1.579,18	2.463	1.843	1.407	910	2.682	2.007	1.532	1.200	2.952	2.209	1.686	1.490
31	1.622,67	2.545	1.904	1.454	940	2.771	2.074	1.583	1.240	3.050	2.282	1.742	1.540
32	1.666,16	2.627	1.966	1.501	970	2.861	2.140	1.634	1.280	3.149	2.356	1.799	1.590
33	1.709,65	2.709	2.027	1.548	1.000	2.950	2.207	1.685	1.320	3.247	2.430	1.855	1.640
34	1.753,14	2.791	2.089	1.594	1.030	3.040	2.274	1.736	1.360	3.346	2.503	1.911	1.690
35	1.796,63	2.874	2.150	1.641	1.060	3.129	2.341	1.787	1.400	3.444	2.577	1.967	1.740
36	1.840,12	2.956	2.211	1.688	1.090	3.218	2.408	1.838	1.440	3.542	2.650	2.023	1.790
37	1.883,61	3.038	2.273	1.735	1.120	3.308	2.475	1.889	1.480	3.641	2.724	2.080	1.840
38	1.927,10	3.120	2.334	1.782	1.150	3.397	2.542	1.940	1.520	3.739	2.798	2.136	1.890
39	1.970,59	3.202	2.396	1.829	1.180	3.487	2.609	1.992	1.560	3.838	2.871	2.192	1.940
40	2.014,08	3.284	2.457	1.876	1.210	3.576	2.676	2.043	1.600	3.936	2.945	2.248	1.990

Precios para color blanco estándar RAL 9016.

Precios para carta de colores Zehnder +25%. Otros colores, consultar.



# Zehnder Excelsior

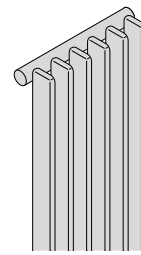
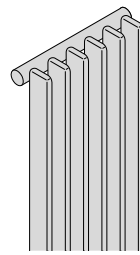
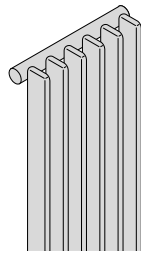
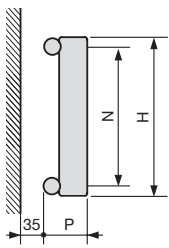

MODELO	E 1090/30	E 1090/40	E 1090/50
Altura H	900 mm	900 mm	900 mm
Entre ejes N	860 mm	860 mm	860 mm
Profundidad P	95 mm	95 mm	95 mm
Distancia entre elementos X	30 mm	40 mm	50 mm
Exponente n	1,29	1,29	1,29

Recuerde pedir el Pack de Conexión

Nº de elementos	Blanco RAL 9016 PVP €	Emisión EN 442 75/65/20 ΔT 50K W	Emisión Caldera condens. ΔT 40K W	Emisión Bomba de calor ΔT 32,5K W	Long. L mm	Emisión EN 442 75/65/20 ΔT 50K W	Emisión Caldera condens. ΔT 40K W	Emisión Bomba de calor ΔT 32,5K W	Long. L mm	Emisión EN 442 75/65/20 ΔT 50K W	Emisión Caldera condens. ΔT 40K W	Emisión Bomba de calor ΔT 32,5K W	Long. L mm
4	272,04	207	155	119	130	222	167	128	160	237	178	136	190
5	295,89	259	194	149	160	278	208	159	200	296	222	170	240
6	319,74	311	233	178	190	334	250	191	240	355	266	204	290
7	343,59	363	272	208	220	389	292	223	280	414	311	238	340
8	367,44	414	311	238	250	445	334	255	320	474	355	272	390
9	391,29	466	350	267	280	500	375	287	360	533	400	306	440
10	415,14	518	388	297	310	556	417	319	400	592	444	340	490
11	438,99	570	427	327	340	612	459	351	440	651	488	374	540
12	462,84	622	466	357	370	667	500	383	480	710	533	408	590
13	486,69	673	505	386	400	723	542	415	520	770	577	441	640
14	510,54	725	544	416	430	778	584	447	560	829	621	475	690
15	534,39	777	583	446	460	834	625	478	600	888	666	509	740
16	558,24	829	621	475	490	890	667	510	640	947	710	543	790
17	582,09	881	660	505	520	945	709	542	680	1.006	755	577	840
18	605,94	932	699	535	550	1.001	750	574	720	1.066	799	611	890
19	629,79	984	738	565	580	1.056	792	606	760	1.125	843	645	940
20	653,64	1.036	777	594	610	1.112	834	638	800	1.184	888	679	990
21	677,49	1.088	816	624	640	1.168	876	670	840	1.243	932	713	1.040
22	701,34	1.140	855	654	670	1.223	917	702	880	1.302	977	747	1.090
23	725,19	1.191	893	683	700	1.279	959	734	920	1.362	1.021	781	1.140
24	749,04	1.243	932	713	730	1.334	1.001	765	960	1.421	1.065	815	1.190
25	772,89	1.295	971	743	760	1.390	1.042	797	1.000	1.480	1.110	849	1.240
26	796,74	1.347	1.010	773	790	1.446	1.084	829	1.040	1.539	1.154	883	1.290
27	820,59	1.399	1.049	802	820	1.501	1.126	861	1.080	1.598	1.199	917	1.340
28	844,44	1.450	1.088	832	850	1.557	1.167	893	1.120	1.658	1.243	951	1.390
29	868,29	1.502	1.126	862	880	1.612	1.209	925	1.160	1.717	1.287	985	1.440
30	892,14	1.554	1.165	891	910	1.668	1.251	957	1.200	1.776	1.332	1.019	1.490
31	915,99	1.606	1.204	921	940	1.724	1.292	989	1.240	1.835	1.376	1.053	1.540
32	939,84	1.658	1.243	951	970	1.779	1.334	1.021	1.280	1.894	1.421	1.087	1.590
33	963,69	1.709	1.282	981	1.000	1.835	1.376	1.053	1.320	1.954	1.465	1.121	1.640
34	987,54	1.761	1.321	1.010	1.030	1.890	1.418	1.084	1.360	2.013	1.509	1.155	1.690
35	1.011,39	1.813	1.360	1.040	1.060	1.946	1.459	1.116	1.400	2.072	1.554	1.189	1.740
36	1.035,24	1.865	1.398	1.070	1.090	2.002	1.501	1.148	1.440	2.131	1.598	1.223	1.790
37	1.059,09	1.917	1.437	1.099	1.120	2.057	1.543	1.180	1.480	2.190	1.643	1.257	1.840
38	1.082,94	1.968	1.476	1.129	1.150	2.113	1.584	1.212	1.520	2.250	1.687	1.291	1.890
39	1.106,79	2.020	1.515	1.159	1.180	2.168	1.626	1.244	1.560	2.309	1.731	1.324	1.940
40	1.130,64	2.072	1.554	1.189	1.210	2.224	1.668	1.276	1.600	2.368	1.776	1.358	1.990

Precios para color blanco estándar RAL 9016.

Precios para carta de colores Zehnder +25%. Otros colores, consultar.



# Zehnder Excelsior

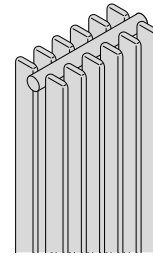
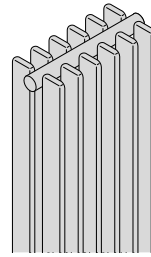
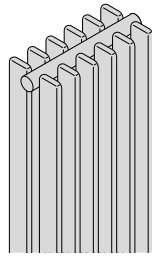
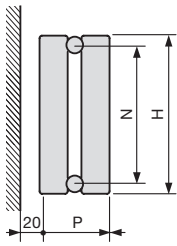

MODELO	E 2090/30	E 2090/40	E 2090/50
Altura H	900 mm	900 mm	900 mm
Entre ejes N	860 mm	860 mm	860 mm
Profundidad P	160 mm	160 mm	160 mm
Distancia entre elementos X	30 mm	40 mm	50 mm
Exponente n	1,31	1,31	1,31

Recuerde pedir el Pack de Conexión

Nº de elementos	Blanco RAL 9016	Emisión EN 442 75/65/20 ΔT 50K W	Emisión Caldera condens. ΔT 40K W	Emisión Bomba de calor ΔT 32,5K W	Long. L mm	Emisión EN 442 75/65/20 ΔT 50K W	Emisión Caldera condens. ΔT 40K W	Emisión Bomba de calor ΔT 32,5K W	Long. L mm	Emisión EN 442 75/65/20 ΔT 50K W	Emisión Caldera condens. ΔT 40K W	Emisión Bomba de calor ΔT 32,5K W	Long. L mm
	PVP €												
4	465,20	362	270	206	130	395	295	225	160	436	325	248	190
5	512,88	452	337	257	160	494	368	281	200	545	407	310	240
6	560,56	542	405	308	190	592	442	337	240	654	488	372	290
7	608,24	633	472	360	220	691	516	393	280	763	570	434	340
8	655,92	723	540	411	250	790	589	449	320	872	651	496	390
9	703,60	814	607	463	280	888	663	505	360	981	732	558	440
10	751,28	904	675	514	310	987	737	561	400	1.090	814	620	490
11	798,96	994	742	566	340	1.086	811	617	440	1.199	895	682	540
12	846,64	1.085	810	617	370	1.184	884	674	480	1.308	976	744	590
13	894,32	1.175	877	668	400	1.283	958	730	520	1.417	1.058	806	640
14	942,00	1.266	945	720	430	1.382	1.032	786	560	1.526	1.139	868	690
15	989,68	1.356	1.012	771	460	1.481	1.105	842	600	1.635	1.221	930	740
16	1.037,36	1.446	1.080	823	490	1.579	1.179	898	640	1.744	1.302	992	790
17	1.085,04	1.537	1.147	874	520	1.678	1.253	954	680	1.853	1.383	1.054	840
18	1.132,72	1.627	1.215	925	550	1.777	1.326	1.010	720	1.962	1.465	1.116	890
19	1.180,40	1.718	1.282	977	580	1.875	1.400	1.067	760	2.071	1.546	1.178	940
20	1.228,08	1.808	1.350	1.028	610	1.974	1.474	1.123	800	2.180	1.627	1.240	990
21	1.275,76	1.898	1.417	1.080	640	2.073	1.547	1.179	840	2.289	1.709	1.302	1.040
22	1.323,44	1.989	1.485	1.131	670	2.171	1.621	1.235	880	2.398	1.790	1.364	1.090
23	1.371,12	2.079	1.552	1.183	700	2.270	1.695	1.291	920	2.507	1.872	1.426	1.140
24	1.418,80	2.170	1.620	1.234	730	2.369	1.768	1.347	960	2.616	1.953	1.488	1.190
25	1.466,48	2.260	1.687	1.285	760	2.468	1.842	1.403	1.000	2.725	2.034	1.550	1.240
26	1.514,16	2.350	1.755	1.337	790	2.566	1.916	1.460	1.040	2.834	2.116	1.612	1.290
27	1.561,84	2.441	1.822	1.388	820	2.665	1.989	1.516	1.080	2.943	2.197	1.674	1.340
28	1.609,52	2.531	1.890	1.440	850	2.764	2.063	1.572	1.120	3.052	2.278	1.736	1.390
29	1.657,20	2.622	1.957	1.491	880	2.862	2.137	1.628	1.160	3.161	2.360	1.798	1.440
30	1.704,88	2.712	2.025	1.542	910	2.961	2.210	1.684	1.200	3.270	2.441	1.860	1.490
31	1.752,56	2.802	2.092	1.594	940	3.060	2.284	1.740	1.240	3.379	2.523	1.922	1.540
32	1.800,24	2.893	2.160	1.645	970	3.158	2.358	1.796	1.280	3.488	2.604	1.984	1.590
33	1.847,92	2.983	2.227	1.697	1.000	3.257	2.432	1.852	1.320	3.597	2.685	2.046	1.640
34	1.895,60	3.074	2.295	1.748	1.030	3.356	2.505	1.909	1.360	3.706	2.767	2.108	1.690
35	1.943,28	3.164	2.362	1.800	1.060	3.455	2.579	1.965	1.400	3.815	2.848	2.170	1.740
36	1.990,96	3.254	2.430	1.851	1.090	3.553	2.653	2.021	1.440	3.924	2.929	2.232	1.790
37	2.038,64	3.345	2.497	1.902	1.120	3.652	2.726	2.077	1.480	4.033	3.011	2.294	1.840
38	2.086,32	3.435	2.564	1.954	1.150	3.751	2.800	2.133	1.520	4.142	3.092	2.356	1.890
39	2.134,00	3.526	2.632	2.005	1.180	3.849	2.874	2.189	1.560	4.251	3.174	2.418	1.940
40	2.181,68	3.616	2.699	2.057	1.210	3.948	2.947	2.245	1.600	4.360	3.255	2.480	1.990

Precios para color blanco estándar RAL 9016.

Precios para carta de colores Zehnder +25%. Otros colores, consultar.



# Zehnder Excelsior

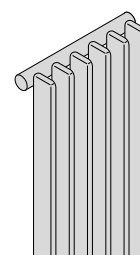
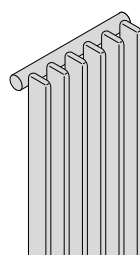
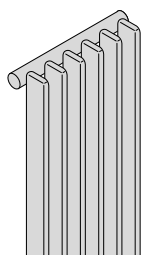
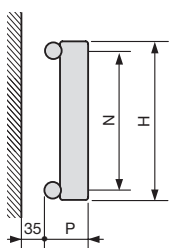

MODELO	E 1100/30	E 1100/40	E 1100/50
Altura H	1000 mm	1000 mm	1000 mm
Entre ejes N	960 mm	960 mm	960 mm
Profundidad P	95 mm	95 mm	95 mm
Distancia entre elementos X	30 mm	40 mm	50 mm
Exponente n	1,30	1,30	1,30

Recuerde pedir el Pack de Conexión

Nº de elementos	Blanco RAL 9016 PVP €	Emisión EN 442 75/65/20 ΔT 50K W	Emisión Caldera condens. ΔT 40K W	Emisión Bomba de calor ΔT 32,5K W	Long. L mm	Emisión EN 442 75/65/20 ΔT 50K W	Emisión Caldera condens. ΔT 40K W	Emisión Bomba de calor ΔT 32,5K W	Long. L mm	Emisión EN 442 75/65/20 ΔT 50K W	Emisión Caldera condens. ΔT 40K W	Emisión Bomba de calor ΔT 32,5K W	Long. L mm
4	280,80	227	170	130	130	244	183	140	160	260	195	149	190
5	306,84	284	212	162	160	306	229	175	200	326	244	186	240
6	332,88	341	255	195	190	367	274	209	240	391	292	223	290
7	358,92	398	297	227	220	428	320	244	280	456	341	260	340
8	384,96	454	340	260	250	489	366	279	320	521	390	297	390
9	411,00	511	382	292	280	550	411	314	360	586	438	335	440
10	437,04	568	425	324	310	611	457	349	400	651	487	372	490
11	463,08	625	467	357	340	672	503	384	440	716	536	409	540
12	489,12	682	510	389	370	733	549	419	480	781	584	446	590
13	515,16	738	552	422	400	794	594	454	520	846	633	483	640
14	541,20	795	595	454	430	855	640	489	560	911	682	521	690
15	567,24	852	637	487	460	917	686	524	600	977	731	558	740
16	593,28	909	680	519	490	978	731	558	640	1.042	779	595	790
17	619,32	966	722	552	520	1.039	777	593	680	1.107	828	632	840
18	645,36	1.022	765	584	550	1.100	823	628	720	1.172	877	669	890
19	671,40	1.079	807	616	580	1.161	869	663	760	1.237	925	707	940
20	697,44	1.136	850	649	610	1.222	914	698	800	1.302	974	744	990
21	723,48	1.193	892	681	640	1.283	960	733	840	1.367	1.023	781	1.040
22	749,52	1.250	935	714	670	1.344	1.006	768	880	1.432	1.072	818	1.090
23	775,56	1.306	977	746	700	1.405	1.051	803	920	1.497	1.120	855	1.140
24	801,60	1.363	1.020	779	730	1.466	1.097	838	960	1.562	1.169	892	1.190
25	827,64	1.420	1.062	811	760	1.528	1.143	873	1.000	1.628	1.218	930	1.240
26	853,68	1.477	1.105	844	790	1.589	1.189	907	1.040	1.693	1.266	967	1.290
27	879,72	1.534	1.147	876	820	1.650	1.234	942	1.080	1.758	1.315	1.004	1.340
28	905,76	1.590	1.190	908	850	1.711	1.280	977	1.120	1.823	1.364	1.041	1.390
29	931,80	1.647	1.232	941	880	1.772	1.326	1.012	1.160	1.888	1.413	1.078	1.440
30	957,84	1.704	1.275	973	910	1.833	1.371	1.047	1.200	1.953	1.461	1.116	1.490
31	983,88	1.761	1.317	1.006	940	1.894	1.417	1.082	1.240	2.018	1.510	1.153	1.540
32	1.009,92	1.818	1.360	1.038	970	1.955	1.463	1.117	1.280	2.083	1.559	1.190	1.590
33	1.035,96	1.874	1.402	1.071	1.000	2.016	1.509	1.152	1.320	2.148	1.607	1.227	1.640
34	1.062,00	1.931	1.445	1.103	1.030	2.077	1.554	1.187	1.360	2.213	1.656	1.264	1.690
35	1.088,04	1.988	1.487	1.136	1.060	2.139	1.600	1.222	1.400	2.279	1.705	1.301	1.740
36	1.114,08	2.045	1.530	1.168	1.090	2.200	1.646	1.256	1.440	2.344	1.753	1.339	1.790
37	1.140,12	2.102	1.572	1.200	1.120	2.261	1.691	1.291	1.480	2.409	1.802	1.376	1.840
38	1.166,16	2.158	1.615	1.233	1.150	2.322	1.737	1.326	1.520	2.474	1.851	1.413	1.890
39	1.192,20	2.215	1.657	1.265	1.180	2.383	1.783	1.361	1.560	2.539	1.900	1.450	1.940
40	1.218,24	2.272	1.700	1.298	1.210	2.444	1.829	1.396	1.600	2.604	1.948	1.487	1.990

Precios para color blanco estándar RAL 9016.

Precios para carta de colores Zehnder +25%. Otros colores, consultar.



# Zehnder Excelsior

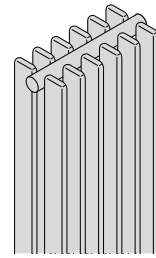
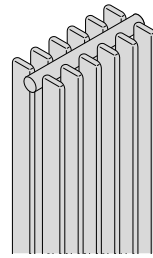
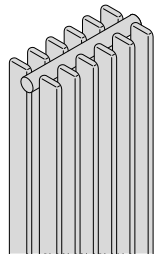
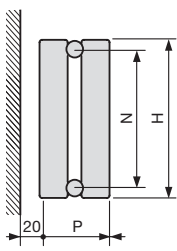

MODELO	E 2100/30	E 2100/40	E 2100/50
Altura H	1000 mm	1000 mm	1000 mm
Entre ejes N	960 mm	960 mm	960 mm
Profundidad P	160 mm	160 mm	160 mm
Distancia entre elementos X	30 mm	40 mm	50 mm
Exponente n	1,32	1,32	1,32

Recuerde pedir el Pack de Conexión

Nº de elementos	Blanco RAL 9016 PVP €	Emisión EN 442 75/65/20 ΔT 50K W	Emisión Caldera condens. ΔT 40K W	Emisión Bomba de calor ΔT 32,5K W	Long. L mm	Emisión EN 442 75/65/20 ΔT 50K W	Emisión Caldera condens. ΔT 40K W	Emisión Bomba de calor ΔT 32,5K W	Long. L mm	Emisión EN 442 75/65/20 ΔT 50K W	Emisión Caldera condens. ΔT 40K W	Emisión Bomba de calor ΔT 32,5K W	Long. L mm
5	535,03	494	368	279	160	540	402	306	200	560	417	317	240
6	587,14	592	441	335	190	648	483	367	240	672	501	381	290
7	639,25	691	515	391	220	756	563	428	280	784	584	444	340
8	691,36	790	588	447	250	864	644	489	320	896	667	507	390
9	743,47	888	662	503	280	972	724	550	360	1.008	751	571	440
10	795,58	987	735	559	310	1.080	804	612	400	1.120	834	634	490
11	847,69	1.086	809	615	340	1.188	885	673	440	1.232	918	698	540
12	899,80	1.184	882	671	370	1.296	965	734	480	1.344	1.001	761	590
13	951,91	1.283	956	727	400	1.404	1.046	795	520	1.456	1.085	825	640
14	1.004,02	1.382	1.029	783	430	1.512	1.126	856	560	1.568	1.168	888	690
15	1.056,13	1.481	1.103	838	460	1.620	1.207	917	600	1.680	1.251	951	740
16	1.108,24	1.579	1.176	894	490	1.728	1.287	979	640	1.792	1.335	1.015	790
17	1.160,35	1.678	1.250	950	520	1.836	1.368	1.040	680	1.904	1.418	1.078	840
18	1.212,46	1.777	1.323	1.006	550	1.944	1.448	1.101	720	2.016	1.502	1.142	890
19	1.264,57	1.875	1.397	1.062	580	2.052	1.528	1.162	760	2.128	1.585	1.205	940
20	1.316,68	1.974	1.470	1.118	610	2.160	1.609	1.223	800	2.240	1.669	1.269	990
21	1.368,79	2.073	1.544	1.174	640	2.268	1.689	1.284	840	2.352	1.752	1.332	1.040
22	1.420,90	2.171	1.617	1.230	670	2.376	1.770	1.346	880	2.464	1.835	1.395	1.090
23	1.473,01	2.270	1.691	1.286	700	2.484	1.850	1.407	920	2.576	1.919	1.459	1.140
24	1.525,12	2.369	1.764	1.341	730	2.592	1.931	1.468	960	2.688	2.002	1.522	1.190
25	1.577,23	2.468	1.838	1.397	760	2.700	2.011	1.529	1.000	2.800	2.086	1.586	1.240
26	1.629,34	2.566	1.911	1.453	790	2.808	2.092	1.590	1.040	2.912	2.169	1.649	1.290
27	1.681,45	2.665	1.985	1.509	820	2.916	2.172	1.651	1.080	3.024	2.252	1.712	1.340
28	1.733,56	2.764	2.059	1.565	850	3.024	2.252	1.712	1.120	3.136	2.336	1.776	1.390
29	1.785,67	2.862	2.132	1.621	880	3.132	2.333	1.774	1.160	3.248	2.419	1.839	1.440
30	1.837,78	2.961	2.206	1.677	910	3.240	2.413	1.835	1.200	3.360	2.503	1.903	1.490
31	1.889,89	3.060	2.279	1.733	940	3.348	2.494	1.896	1.240	3.472	2.586	1.966	1.540
32	1.942,00	3.158	2.353	1.789	970	3.456	2.574	1.957	1.280	3.584	2.670	2.030	1.590
33	1.994,11	3.257	2.426	1.844	1.000	3.564	2.655	2.018	1.320	3.696	2.753	2.093	1.640
34	2.046,22	3.356	2.500	1.900	1.030	3.672	2.735	2.079	1.360	3.808	2.836	2.156	1.690
35	2.098,33	3.455	2.573	1.956	1.060	3.780	2.816	2.141	1.400	3.920	2.920	2.220	1.740
36	2.150,44	3.553	2.647	2.012	1.090	3.888	2.896	2.202	1.440	4.032	3.003	2.283	1.790
37	2.202,55	3.652	2.720	2.068	1.120	3.996	2.976	2.263	1.480	4.144	3.087	2.347	1.840
38	2.254,66	3.751	2.794	2.124	1.150	4.104	3.057	2.324	1.520	4.256	3.170	2.410	1.890
39	2.306,77	3.849	2.867	2.180	1.180	4.212	3.137	2.385	1.560	4.368	3.254	2.474	1.940
40	2.358,88	3.948	2.941	2.236	1.210	4.320	3.218	2.446	1.600	4.480	3.337	2.537	1.990

Precios para color blanco estándar RAL 9016.

Precios para carta de colores Zehnder +25%. Otros colores, consultar.



# Zehnder Excelsior

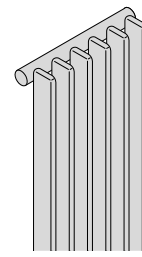
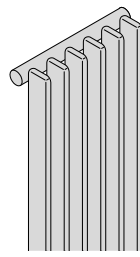
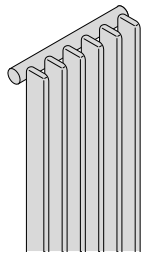
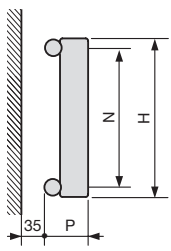

MODELO	E 1120/30	E 1120/40	E 1120/50
Altura H	1200 mm	1200 mm	1200 mm
Entre ejes N	1160 mm	1160 mm	1160 mm
Profundidad P	95 mm	95 mm	95 mm
Distancia entre elementos X	30 mm	40 mm	50 mm
Exponente n	1,29	1,29	1,29

Recuerde pedir el Pack de Conexión

Nº de elementos	Blanco RAL 9016 PVP €	Emisión EN 442 75/65/20 ΔT 50K W	Emisión Caldera condens. ΔT 40K W	Emisión Bomba de calor ΔT 32,5K W	Long. L mm	Emisión EN 442 75/65/20 ΔT 50K W	Emisión Caldera condens. ΔT 40K W	Emisión Bomba de calor ΔT 32,5K W	Long. L mm	Emisión EN 442 75/65/20 ΔT 50K W	Emisión Caldera condens. ΔT 40K W	Emisión Bomba de calor ΔT 32,5K W	Long. L mm
4	241,13	268	201	154	130	289	217	166	160	308	231	177	190
5	281,16	335	251	192	160	361	271	207	200	386	289	221	240
6	321,19	402	301	231	190	433	325	249	240	463	347	265	290
7	361,22	469	352	269	220	505	379	290	280	540	405	310	340
8	401,25	536	402	307	250	578	433	331	320	617	463	354	390
9	441,28	603	452	346	280	650	487	373	360	694	520	398	440
10	481,31	670	502	384	310	722	541	414	400	771	578	442	490
11	521,34	737	553	423	340	794	596	456	440	848	636	487	540
12	561,37	804	603	461	370	866	650	497	480	925	694	531	590
13	601,40	871	653	500	400	939	704	538	520	1.002	752	575	640
14	641,43	938	703	538	430	1.011	758	580	560	1.079	809	619	690
15	681,46	1.005	754	577	460	1.083	812	621	600	1.157	867	663	740
16	721,49	1.072	804	615	490	1.155	866	663	640	1.234	925	708	790
17	761,52	1.139	854	653	520	1.227	920	704	680	1.311	983	752	840
18	801,55	1.206	904	692	550	1.300	975	746	720	1.388	1.041	796	890
19	841,58	1.273	955	730	580	1.372	1.029	787	760	1.465	1.098	840	940
20	881,61	1.340	1.005	769	610	1.444	1.083	828	800	1.542	1.156	885	990
21	921,64	1.407	1.055	807	640	1.516	1.137	870	840	1.619	1.214	929	1.040
22	961,67	1.474	1.105	846	670	1.588	1.191	911	880	1.696	1.272	973	1.090
23	1.001,70	1.541	1.156	884	700	1.661	1.245	953	920	1.773	1.330	1.017	1.140
24	1.041,73	1.608	1.206	922	730	1.733	1.299	994	960	1.850	1.388	1.062	1.190
25	1.081,76	1.675	1.256	961	760	1.805	1.354	1.035	1.000	1.928	1.445	1.106	1.240
26	1.121,79	1.742	1.306	999	790	1.877	1.408	1.077	1.040	2.005	1.503	1.150	1.290
27	1.161,82	1.809	1.357	1.038	820	1.949	1.462	1.118	1.080	2.082	1.561	1.194	1.340
28	1.201,85	1.876	1.407	1.076	850	2.022	1.516	1.160	1.120	2.159	1.619	1.238	1.390
29	1.241,88	1.943	1.457	1.115	880	2.094	1.570	1.201	1.160	2.236	1.677	1.283	1.440
30	1.281,91	2.010	1.507	1.153	910	2.166	1.624	1.243	1.200	2.313	1.734	1.327	1.490
31	1.321,94	2.077	1.557	1.192	940	2.238	1.678	1.284	1.240	2.390	1.792	1.371	1.540
32	1.361,97	2.144	1.608	1.230	970	2.310	1.733	1.325	1.280	2.467	1.850	1.415	1.590
33	1.402,00	2.211	1.658	1.268	1.000	2.383	1.787	1.367	1.320	2.544	1.908	1.460	1.640
34	1.442,03	2.278	1.708	1.307	1.030	2.455	1.841	1.408	1.360	2.621	1.966	1.504	1.690
35	1.482,06	2.345	1.758	1.345	1.060	2.527	1.895	1.450	1.400	2.699	2.024	1.548	1.740
36	1.522,09	2.412	1.809	1.384	1.090	2.599	1.949	1.491	1.440	2.776	2.081	1.592	1.790
37	1.562,12	2.479	1.859	1.422	1.120	2.671	2.003	1.532	1.480	2.853	2.139	1.636	1.840
38	1.602,15	2.546	1.909	1.461	1.150	2.744	2.057	1.574	1.520	2.930	2.197	1.681	1.890
39	1.642,18	2.613	1.959	1.499	1.180	2.816	2.111	1.615	1.560	3.007	2.255	1.725	1.940
40	1.682,21	2.680	2.010	1.537	1.210	2.888	2.166	1.657	1.600	3.084	2.313	1.769	1.990

Precios para color blanco estándar RAL 9016.  
Precios para carta de colores Zehnder +25%. Otros colores, consultar.





# Zehnder Excelsior

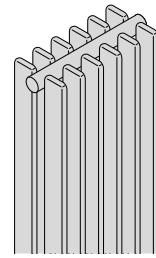
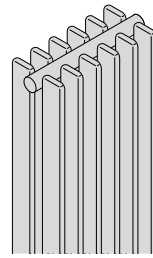
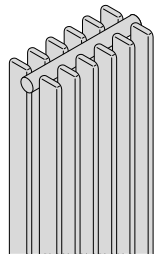
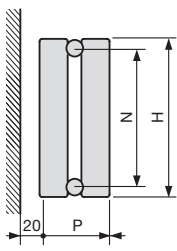

MODELO	E 2120/30	E 2120/40	E 2120/50
Altura H	1200 mm	1200 mm	1200 mm
Entre ejes N	1160 mm	1160 mm	1160 mm
Profundidad P	160 mm	160 mm	160 mm
Distancia entre elementos X	30 mm	40 mm	50 mm
Exponente n	1,32	1,32	1,32

Recuerde pedir el Pack de Conexión

Nº de elementos	Blanco RAL 9016 PVP €	Emisión			Long. L mm	Emisión			Long. L mm	Emisión			Long. L mm
		EN 442 75/65/20 ΔT 50K W	Caldera condens. ΔT 40K W	Bomba de calor ΔT 32,5K W		EN 442 75/65/20 ΔT 50K W	Caldera condens. ΔT 40K W	Bomba de calor ΔT 32,5K W		EN 442 75/65/20 ΔT 50K W	Caldera condens. ΔT 40K W	Bomba de calor ΔT 32,5K W	
4	517,41	460	343	260	130	508	378	288	160	564	420	319	190
5	578,14	575	428	326	160	635	473	360	200	705	525	399	240
6	638,87	690	514	391	190	762	568	432	240	846	630	479	290
7	699,60	805	600	456	220	889	662	503	280	987	735	559	340
8	760,33	920	685	521	250	1.016	757	575	320	1.128	840	639	390
9	821,06	1.035	771	586	280	1.143	851	647	360	1.269	945	719	440
10	881,79	1.150	857	651	310	1.270	946	719	400	1.410	1.050	798	490
11	942,52	1.265	942	716	340	1.397	1.041	791	440	1.551	1.155	878	540
12	1.003,25	1.380	1.028	781	370	1.524	1.135	863	480	1.692	1.260	958	590
13	1.063,98	1.495	1.114	847	400	1.651	1.230	935	520	1.833	1.365	1.038	640
14	1.124,71	1.610	1.199	912	430	1.778	1.324	1.007	560	1.974	1.470	1.118	690
15	1.185,44	1.725	1.285	977	460	1.905	1.419	1.079	600	2.115	1.575	1.198	740
16	1.246,17	1.840	1.371	1.042	490	2.032	1.514	1.151	640	2.256	1.680	1.278	790
17	1.306,90	1.955	1.456	1.107	520	2.159	1.608	1.223	680	2.397	1.785	1.357	840
18	1.367,63	2.070	1.542	1.172	550	2.286	1.703	1.295	720	2.538	1.890	1.437	890
19	1.428,36	2.185	1.628	1.237	580	2.413	1.797	1.366	760	2.679	1.995	1.517	940
20	1.489,09	2.300	1.713	1.302	610	2.540	1.892	1.438	800	2.820	2.101	1.597	990
21	1.549,82	2.415	1.799	1.368	640	2.667	1.987	1.510	840	2.961	2.206	1.677	1.040
22	1.610,55	2.530	1.885	1.433	670	2.794	2.081	1.582	880	3.102	2.311	1.757	1.090
23	1.671,28	2.645	1.970	1.498	700	2.921	2.176	1.654	920	3.243	2.416	1.837	1.140
24	1.732,01	2.760	2.056	1.563	730	3.048	2.270	1.726	960	3.384	2.521	1.916	1.190
25	1.792,74	2.875	2.141	1.628	760	3.175	2.365	1.798	1.000	3.525	2.626	1.996	1.240
26	1.853,47	2.990	2.227	1.693	790	3.302	2.460	1.870	1.040	3.666	2.731	2.076	1.290
27	1.914,20	3.105	2.313	1.758	820	3.429	2.554	1.942	1.080	3.807	2.836	2.156	1.340
28	1.974,93	3.220	2.398	1.823	850	3.556	2.649	2.014	1.120	3.948	2.941	2.236	1.390
29	2.035,66	3.335	2.484	1.889	880	3.683	2.743	2.086	1.160	4.089	3.046	2.316	1.440
30	2.096,39	3.450	2.570	1.954	910	3.810	2.838	2.158	1.200	4.230	3.151	2.395	1.490
31	2.157,12	3.565	2.655	2.019	940	3.937	2.933	2.230	1.240	4.371	3.256	2.475	1.540
32	2.217,85	3.680	2.741	2.084	970	4.064	3.027	2.301	1.280	4.512	3.361	2.555	1.590
33	2.278,58	3.795	2.827	2.149	1.000	4.191	3.122	2.373	1.320	4.653	3.466	2.635	1.640
34	2.339,31	3.910	2.912	2.214	1.030	4.318	3.216	2.445	1.360	4.794	3.571	2.715	1.690
35	2.400,04	4.025	2.998	2.279	1.060	4.445	3.311	2.517	1.400	4.935	3.676	2.795	1.740
36	2.460,77	4.140	3.084	2.344	1.090	4.572	3.406	2.589	1.440	5.076	3.781	2.875	1.790
37	2.521,50	4.255	3.169	2.410	1.120	4.699	3.500	2.661	1.480	5.217	3.886	2.954	1.840
38	2.582,23	4.370	3.255	2.475	1.150	4.826	3.595	2.733	1.520	5.358	3.991	3.034	1.890
39	2.642,96	4.485	3.341	2.540	1.180	4.953	3.689	2.805	1.560	5.499	4.096	3.114	1.940
40	2.703,69	4.600	3.426	2.605	1.210	5.080	3.784	2.877	1.600	5.640	4.201	3.194	1.990

Precios para color blanco estándar RAL 9016.

Precios para carta de colores Zehnder +25%. Otros colores, consultar.



# Zehnder Excelsior

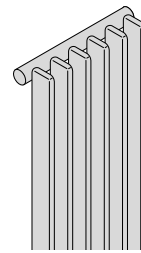
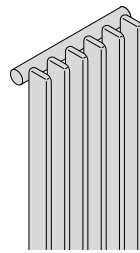
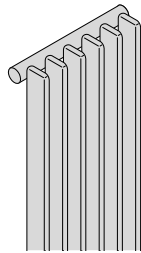
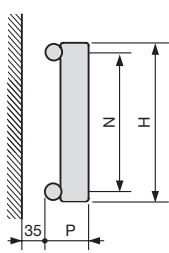

MODELO	E 1150/30	E 1150/40	E 1150/50
Altura H	1500	1500	1500
Entre ejes N	1460	1460	1460
Profundidad P	95	95	95
Distancia entre elementos X	30	40	50
Exponente n	1,29	1,29	1,29

Recuerde pedir el Pack de Conexión

Nº de elementos	Blanco RAL 9016 PVP €	Emisión EN 442 75/65/20 ΔT 50K W	Emisión Caldera condens. ΔT 40K W	Emisión Bomba de calor ΔT 32,5K W	Long. L mm	Emisión EN 442 75/65/20 ΔT 50K W	Emisión Caldera condens. ΔT 40K W	Emisión Bomba de calor ΔT 32,5K W	Long. L mm	Emisión EN 442 75/65/20 ΔT 50K W	Emisión Caldera condens. ΔT 40K W	Emisión Bomba de calor ΔT 32,5K W	Long. L mm
4	325,52	331	248	190	130	359	269	206	160	386	290	222	190
5	362,74	414	310	237	160	449	337	258	200	483	362	277	240
6	399,96	497	373	285	190	539	404	309	240	580	435	332	290
7	437,18	580	435	332	220	629	471	361	280	676	507	388	340
8	474,40	662	497	380	250	718	539	412	320	773	579	443	390
9	511,62	745	559	427	280	808	606	464	360	869	652	499	440
10	548,84	828	621	475	310	898	673	515	400	966	724	554	490
11	586,06	911	683	522	340	988	741	567	440	1.063	797	610	540
12	623,28	994	745	570	370	1.078	808	618	480	1.159	869	665	590
13	660,50	1.076	807	617	400	1.167	875	670	520	1.256	942	720	640
14	697,72	1.159	869	665	430	1.257	943	721	560	1.352	1.014	776	690
15	734,94	1.242	931	712	460	1.347	1.010	773	600	1.449	1.087	831	740
16	772,16	1.325	993	760	490	1.437	1.077	824	640	1.546	1.159	887	790
17	809,38	1.408	1.056	807	520	1.527	1.145	876	680	1.642	1.231	942	840
18	846,60	1.490	1.118	855	550	1.616	1.212	927	720	1.739	1.304	997	890
19	883,82	1.573	1.180	902	580	1.706	1.279	979	760	1.835	1.376	1.053	940
20	921,04	1.656	1.242	950	610	1.796	1.347	1.030	800	1.932	1.449	1.108	990
21	958,26	1.739	1.304	997	640	1.886	1.414	1.082	840	2.029	1.521	1.164	1.040
22	995,48	1.822	1.366	1.045	670	1.976	1.481	1.133	880	2.125	1.594	1.219	1.090
23	1.032,70	1.904	1.428	1.092	700	2.065	1.549	1.185	920	2.222	1.666	1.275	1.140
24	1.069,92	1.987	1.490	1.140	730	2.155	1.616	1.236	960	2.318	1.738	1.330	1.190
25	1.107,14	2.070	1.552	1.187	760	2.245	1.683	1.288	1.000	2.415	1.811	1.385	1.240
26	1.144,36	2.153	1.614	1.235	790	2.335	1.751	1.339	1.040	2.512	1.883	1.441	1.290
27	1.181,58	2.236	1.676	1.282	820	2.425	1.818	1.391	1.080	2.608	1.956	1.496	1.340
28	1.218,80	2.318	1.738	1.330	850	2.514	1.885	1.442	1.120	2.705	2.028	1.552	1.390
29	1.256,02	2.401	1.801	1.377	880	2.604	1.953	1.494	1.160	2.801	2.101	1.607	1.440
30	1.293,24	2.484	1.863	1.425	910	2.694	2.020	1.545	1.200	2.898	2.173	1.662	1.490
31	1.330,46	2.567	1.925	1.472	940	2.784	2.087	1.597	1.240	2.995	2.246	1.718	1.540
32	1.367,68	2.650	1.987	1.520	970	2.874	2.155	1.648	1.280	3.091	2.318	1.773	1.590
33	1.404,90	2.732	2.049	1.567	1.000	2.963	2.222	1.700	1.320	3.188	2.390	1.829	1.640
34	1.442,12	2.815	2.111	1.615	1.030	3.053	2.290	1.752	1.360	3.284	2.463	1.884	1.690
35	1.479,34	2.898	2.173	1.662	1.060	3.143	2.357	1.803	1.400	3.381	2.535	1.940	1.740
36	1.516,56	2.981	2.235	1.710	1.090	3.233	2.424	1.855	1.440	3.478	2.608	1.995	1.790
37	1.553,78	3.064	2.297	1.757	1.120	3.323	2.492	1.906	1.480	3.574	2.680	2.050	1.840
38	1.591,00	3.146	2.359	1.805	1.150	3.412	2.559	1.958	1.520	3.671	2.753	2.106	1.890
39	1.628,22	3.229	2.421	1.852	1.180	3.502	2.626	2.009	1.560	3.767	2.825	2.161	1.940
40	1.665,44	3.312	2.484	1.900	1.210	3.592	2.694	2.061	1.600	3.864	2.897	2.217	1.990

Precios para color blanco estándar RAL 9016.  
Precios para carta de colores Zehnder +25%. Otros colores, consultar.



# Zehnder Excelsior

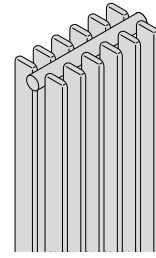
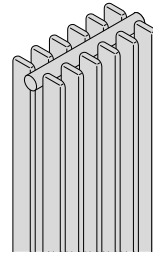
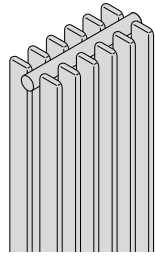
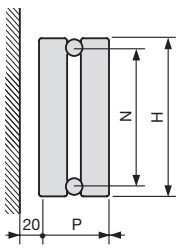

MODELO	E 2150/30	E 2150/40	E 2150/50
Altura H	1500	1500	1500
Entre ejes N	1460	1460	1460
Profundidad P	160	160	160
Distancia entre elementos X	30	40	50
Exponente n	1,32	1,32	1,32

Recuerde pedir el Pack de Conexión

Nº de elementos	Blanco RAL 9016 PVP €	Emisión EN 442 75/65/20 ΔT 50K W	Emisión Caldera condens. ΔT 40K W	Emisión Bomba de calor ΔT 32,5K W	Long. L mm	Emisión EN 442 75/65/20 ΔT 50K W	Emisión Caldera condens. ΔT 40K W	Emisión Bomba de calor ΔT 32,5K W	Long. L mm	Emisión EN 442 75/65/20 ΔT 50K W	Emisión Caldera condens. ΔT 40K W	Emisión Bomba de calor ΔT 32,5K W	Long. L mm
4	572,52	560	417	317	130	620	462	351	160	688	512	390	190
5	647,03	700	521	396	160	775	577	439	200	860	641	487	240
6	721,54	840	626	476	190	930	693	527	240	1.032	769	584	290
7	796,05	980	730	555	220	1.085	808	614	280	1.204	897	682	340
8	870,56	1.120	834	634	250	1.240	924	702	320	1.376	1.025	779	390
9	945,07	1.260	939	714	280	1.395	1.039	790	360	1.548	1.153	877	440
10	1.019,58	1.400	1.043	793	310	1.550	1.155	878	400	1.720	1.281	974	490
11	1.094,09	1.540	1.147	872	340	1.705	1.270	966	440	1.892	1.409	1.071	540
12	1.168,60	1.680	1.251	951	370	1.860	1.385	1.053	480	2.064	1.537	1.169	590
13	1.243,11	1.820	1.356	1.031	400	2.015	1.501	1.141	520	2.236	1.666	1.266	640
14	1.317,62	1.960	1.460	1.110	430	2.170	1.616	1.229	560	2.408	1.794	1.364	690
15	1.392,13	2.100	1.564	1.189	460	2.325	1.732	1.317	600	2.580	1.922	1.461	740
16	1.466,64	2.240	1.669	1.269	490	2.480	1.847	1.404	640	2.752	2.050	1.558	790
17	1.541,15	2.380	1.773	1.348	520	2.635	1.963	1.492	680	2.924	2.178	1.656	840
18	1.615,66	2.520	1.877	1.427	550	2.790	2.078	1.580	720	3.096	2.306	1.753	890
19	1.690,17	2.660	1.981	1.506	580	2.945	2.194	1.668	760	3.268	2.434	1.851	940
20	1.764,68	2.800	2.086	1.586	610	3.100	2.309	1.756	800	3.440	2.562	1.948	990
21	1.839,19	2.940	2.190	1.665	640	3.255	2.425	1.843	840	3.612	2.690	2.045	1.040
22	1.913,70	3.080	2.294	1.744	670	3.410	2.540	1.931	880	3.784	2.819	2.143	1.090
23	1.988,21	3.220	2.398	1.823	700	3.565	2.655	2.019	920	3.956	2.947	2.240	1.140
24	2.062,72	3.360	2.503	1.903	730	3.720	2.771	2.107	960	4.128	3.075	2.338	1.190
25	2.137,23	3.500	2.607	1.982	760	3.875	2.886	2.194	1.000	4.300	3.203	2.435	1.240
26	2.211,74	3.640	2.711	2.061	790	4.030	3.002	2.282	1.040	4.472	3.331	2.532	1.290
27	2.286,25	3.780	2.816	2.141	820	4.185	3.117	2.370	1.080	4.644	3.459	2.630	1.340
28	2.360,76	3.920	2.920	2.220	850	4.340	3.233	2.458	1.120	4.816	3.587	2.727	1.390
29	2.435,27	4.060	3.024	2.299	880	4.495	3.348	2.546	1.160	4.988	3.715	2.825	1.440
30	2.509,78	4.200	3.128	2.378	910	4.650	3.464	2.633	1.200	5.160	3.844	2.922	1.490
31	2.584,29	4.340	3.233	2.458	940	4.805	3.579	2.721	1.240	5.332	3.972	3.020	1.540
32	2.658,80	4.480	3.337	2.537	970	4.960	3.695	2.809	1.280	5.504	4.100	3.117	1.590
33	2.733,31	4.620	3.441	2.616	1.000	5.115	3.810	2.897	1.320	5.676	4.228	3.214	1.640
34	2.807,82	4.760	3.546	2.696	1.030	5.270	3.925	2.984	1.360	5.848	4.356	3.312	1.690
35	2.882,33	4.900	3.650	2.775	1.060	5.425	4.041	3.072	1.400	6.020	4.484	3.409	1.740
36	2.956,84	5.040	3.754	2.854	1.090	5.580	4.156	3.160	1.440	6.192	4.612	3.507	1.790
37	3.031,35	5.180	3.858	2.933	1.120	5.735	4.272	3.248	1.480	6.364	4.740	3.604	1.840
38	3.105,86	5.320	3.963	3.013	1.150	5.890	4.387	3.335	1.520	6.536	4.868	3.701	1.890
39	3.180,37	5.460	4.067	3.092	1.180	6.045	4.503	3.423	1.560	6.708	4.997	3.799	1.940
40	3.254,88	5.600	4.171	3.171	1.210	6.200	4.618	3.511	1.600	6.880	5.125	3.896	1.990

Precios para color blanco estándar RAL 9016.  
Precios para carta de colores Zehnder +25%. Otros colores, consultar.



# Zehnder Excelsior

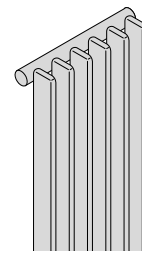
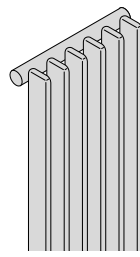
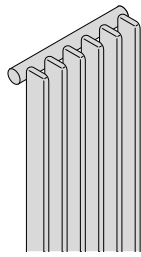
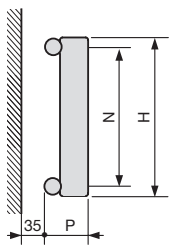

MODELO	E 1180/30	E 1180/40	E 1180/50
Altura H	1800	1800	1800
Entre ejes N	1760	1760	1760
Profundidad P	95	95	95
Distancia entre elementos X	30	40	50
Exponente n	1,29	1,29	1,29

Nº de elementos	Blanco RAL 9016 PVP €	Recuerde pedir el Pack de Conexión											
		Emisión EN 442 75/65/20 ΔT 50K W	Emisión Caldera condens. ΔT 40K W	Emisión Bomba de calor ΔT 32,5K W	Long. L mm	Emisión EN 442 75/65/20 ΔT 50K W	Emisión Caldera condens. ΔT 40K W	Emisión Bomba de calor ΔT 32,5K W	Long. L mm	Emisión EN 442 75/65/20 ΔT 50K W	Emisión Caldera condens. ΔT 40K W	Emisión Bomba de calor ΔT 32,5K W	Long. L mm
4	335,14	398	298	228	130	436	327	250	160	472	354	271	190
5	378,05	498	373	285	160	545	409	313	200	590	442	338	240
6	420,96	597	448	342	190	654	490	375	240	708	531	406	290
7	463,87	697	522	400	220	763	572	438	280	826	619	474	340
8	506,78	796	597	457	250	872	654	500	320	944	708	542	390
9	549,69	896	672	514	280	981	736	563	360	1.062	796	609	440
10	592,60	995	746	571	310	1.090	817	625	400	1.180	885	677	490
11	635,51	1.095	821	628	340	1.199	899	688	440	1.298	973	745	540
12	678,42	1.194	895	685	370	1.308	981	750	480	1.416	1.062	812	590
13	721,33	1.294	970	742	400	1.417	1.063	813	520	1.534	1.150	880	640
14	764,24	1.393	1.045	799	430	1.526	1.144	875	560	1.652	1.239	948	690
15	807,15	1.493	1.119	856	460	1.635	1.226	938	600	1.770	1.327	1.015	740
16	850,06	1.592	1.194	913	490	1.744	1.308	1.000	640	1.888	1.416	1.083	790
17	892,97	1.692	1.268	970	520	1.853	1.390	1.063	680	2.006	1.504	1.151	840
18	935,88	1.791	1.343	1.027	550	1.962	1.471	1.126	720	2.124	1.593	1.218	890
19	978,79	1.891	1.418	1.085	580	2.071	1.553	1.188	760	2.242	1.681	1.286	940
20	1.021,70	1.990	1.492	1.142	610	2.180	1.635	1.251	800	2.360	1.770	1.354	990
21	1.064,61	2.090	1.567	1.199	640	2.289	1.716	1.313	840	2.478	1.858	1.422	1.040
22	1.107,52	2.189	1.641	1.256	670	2.398	1.798	1.376	880	2.596	1.947	1.489	1.090
23	1.150,43	2.289	1.716	1.313	700	2.507	1.880	1.438	920	2.714	2.035	1.557	1.140
24	1.193,34	2.388	1.791	1.370	730	2.616	1.962	1.501	960	2.832	2.124	1.625	1.190
25	1.236,25	2.488	1.865	1.427	760	2.725	2.043	1.563	1.000	2.950	2.212	1.692	1.240
26	1.279,16	2.587	1.940	1.484	790	2.834	2.125	1.626	1.040	3.068	2.301	1.760	1.290
27	1.322,07	2.687	2.015	1.541	820	2.943	2.207	1.688	1.080	3.186	2.389	1.828	1.340
28	1.364,98	2.786	2.089	1.598	850	3.052	2.289	1.751	1.120	3.304	2.478	1.895	1.390
29	1.407,89	2.886	2.164	1.655	880	3.161	2.370	1.813	1.160	3.422	2.566	1.963	1.440
30	1.450,80	2.985	2.238	1.712	910	3.270	2.452	1.876	1.200	3.540	2.655	2.031	1.490
31	1.493,71	3.085	2.313	1.769	940	3.379	2.534	1.938	1.240	3.658	2.743	2.098	1.540
32	1.536,62	3.184	2.388	1.827	970	3.488	2.616	2.001	1.280	3.776	2.832	2.166	1.590
33	1.579,53	3.284	2.462	1.884	1.000	3.597	2.697	2.063	1.320	3.894	2.920	2.234	1.640
34	1.622,44	3.383	2.537	1.941	1.030	3.706	2.779	2.126	1.360	4.012	3.008	2.302	1.690
35	1.665,35	3.483	2.611	1.998	1.060	3.815	2.861	2.189	1.400	4.130	3.097	2.369	1.740
36	1.708,26	3.582	2.686	2.055	1.090	3.924	2.942	2.251	1.440	4.248	3.185	2.437	1.790
37	1.751,17	3.682	2.761	2.112	1.120	4.033	3.024	2.314	1.480	4.366	3.274	2.505	1.840
38	1.794,08	3.781	2.835	2.169	1.150	4.142	3.106	2.376	1.520	4.484	3.362	2.572	1.890
39	1.836,99	3.881	2.910	2.226	1.180	4.251	3.188	2.439	1.560	4.602	3.451	2.640	1.940
40	1.879,90	3.980	2.984	2.283	1.210	4.360	3.269	2.501	1.600	4.720	3.539	2.708	1.990

Precios para color blanco estándar RAL 9016.  
Precios para carta de colores Zehnder +25%. Otros colores, consultar.



# Zehnder Excelsior

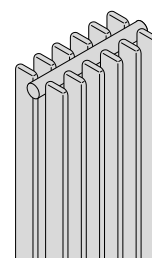
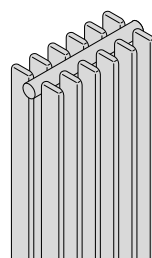
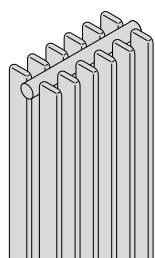
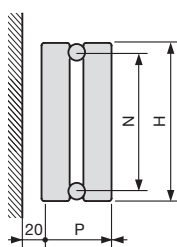

MODELO	E 2180/30	E 2180/40	E 2180/50
Altura H	1800	1800	1800
Entre ejes N	1760	1760	1760
Profundidad P	160	160	160
Distancia entre elementos X	30	40	50
Exponente n	1,32	1,32	1,32

Nº de elementos	Blanco RAL 9016 PVP €	Emisión EN 442 75/65/20 ΔT 50K W	Emisión Caldera condens. ΔT 40K W	Emisión Bomba de calor ΔT 32,5K W	Long. L mm	Emisión EN 442 75/65/20 ΔT 50K W	Emisión Caldera condens. ΔT 40K W	Emisión Bomba de calor ΔT 32,5K W	Long. L mm	Recuerde pedir el Pack de Conexión			
										Emisión EN 442 75/65/20 ΔT 50K W	Emisión Caldera condens. ΔT 40K W	Emisión Bomba de calor ΔT 32,5K W	Long. L mm
4	606,77	664	495	376	130	736	548	417	160	808	602	458	190
5	693,13	830	618	470	160	920	685	521	200	1.010	752	572	240
6	779,49	996	742	564	190	1.104	822	625	240	1.212	903	686	290
7	865,85	1.162	866	658	220	1.288	959	729	280	1.414	1.053	801	340
8	952,21	1.328	989	752	250	1.472	1.096	834	320	1.616	1.204	915	390
9	1.038,57	1.494	1.113	846	280	1.656	1.233	938	360	1.818	1.354	1.030	440
10	1.124,93	1.660	1.236	940	310	1.840	1.371	1.042	400	2.020	1.505	1.144	490
11	1.211,29	1.826	1.360	1.034	340	2.024	1.508	1.146	440	2.222	1.655	1.258	540
12	1.297,65	1.992	1.484	1.128	370	2.208	1.645	1.250	480	2.424	1.806	1.373	590
13	1.384,01	2.158	1.607	1.222	400	2.392	1.782	1.355	520	2.626	1.956	1.487	640
14	1.470,37	2.324	1.731	1.316	430	2.576	1.919	1.459	560	2.828	2.106	1.601	690
15	1.556,73	2.490	1.855	1.410	460	2.760	2.056	1.563	600	3.030	2.257	1.716	740
16	1.643,09	2.656	1.978	1.504	490	2.944	2.193	1.667	640	3.232	2.407	1.830	790
17	1.729,45	2.822	2.102	1.598	520	3.128	2.330	1.771	680	3.434	2.558	1.945	840
18	1.815,81	2.988	2.226	1.692	550	3.312	2.467	1.876	720	3.636	2.708	2.059	890
19	1.902,17	3.154	2.349	1.786	580	3.496	2.604	1.980	760	3.838	2.859	2.173	940
20	1.988,53	3.320	2.473	1.880	610	3.680	2.741	2.084	800	4.040	3.009	2.288	990
21	2.074,89	3.486	2.597	1.974	640	3.864	2.878	2.188	840	4.242	3.160	2.402	1.040
22	2.161,25	3.652	2.720	2.068	670	4.048	3.015	2.292	880	4.444	3.310	2.517	1.090
23	2.247,61	3.818	2.844	2.162	700	4.232	3.152	2.397	920	4.646	3.461	2.631	1.140
24	2.333,97	3.984	2.968	2.256	730	4.416	3.289	2.501	960	4.848	3.611	2.745	1.190
25	2.420,33	4.150	3.091	2.350	760	4.600	3.426	2.605	1.000	5.050	3.762	2.860	1.240
26	2.506,69	4.316	3.215	2.444	790	4.784	3.563	2.709	1.040	5.252	3.912	2.974	1.290
27	2.593,05	4.482	3.338	2.538	820	4.968	3.700	2.813	1.080	5.454	4.063	3.089	1.340
28	2.679,41	4.648	3.462	2.632	850	5.152	3.838	2.918	1.120	5.656	4.213	3.203	1.390
29	2.765,77	4.814	3.586	2.726	880	5.336	3.975	3.022	1.160	5.858	4.363	3.317	1.440
30	2.852,13	4.980	3.709	2.820	910	5.520	4.112	3.126	1.200	6.060	4.514	3.432	1.490
31	2.938,49	5.146	3.833	2.914	940	5.704	4.249	3.230	1.240				
32	3.024,85	5.312	3.957	3.008	970	5.888	4.386	3.334	1.280				
33	3.111,21	5.478	4.080	3.102	1.000	6.072	4.523	3.439	1.320				
34	3.197,57	5.644	4.204	3.196	1.030	6.256	4.660	3.543	1.360				
35	3.283,93	5.810	4.328	3.290	1.060	6.440	4.797	3.647	1.400				
36	3.370,29	5.976	4.451	3.384	1.090	6.624	4.934	3.751	1.440				
37	3.456,65	6.142	4.575	3.478	1.120	6.808	5.071	3.855	1.480				
38	3.543,01	6.308	4.699	3.572	1.150	6.992	5.208	3.960	1.520				
39	3.629,37	6.474	4.822	3.666	1.180								
40	3.715,73	6.640	4.946	3.760	1.210								

Precios para color blanco estándar RAL 9016.  
Precios para carta de colores Zehnder +25%. Otros colores, consultar.



# Zehnder Excelsior

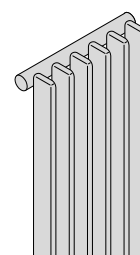
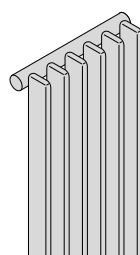
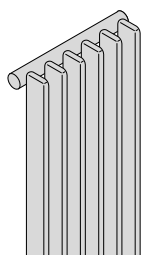
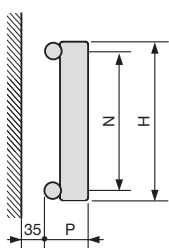

MODELO	E 1200/30	E 1200/40	E 1200/50
Altura H	2000	2000	2000
Entre ejes N	1960	1960	1960
Profundidad P	95	95	95
Distancia entre elementos X	30	40	50
Exponente n	1,29	1,29	1,29

Recuerde pedir el Pack de Conexión

Nº de elementos	Blanco RAL 9016 PVP €	Emisión EN 442 75/65/20 ΔT 50K W	Emisión Caldera condens. ΔT 40K W	Emisión Bomba de calor ΔT 32,5K W	Long. L mm	Emisión EN 442 75/65/20 ΔT 50K W	Emisión Caldera condens. ΔT 40K W	Emisión Bomba de calor ΔT 32,5K W	Long. L mm	Emisión EN 442 75/65/20 ΔT 50K W	Emisión Caldera condens. ΔT 40K W	Emisión Bomba de calor ΔT 32,5K W	Long. L mm
4	355,02	444	333	255	130	488	366	280	160	532	399	305	190
5	402,90	555	416	318	160	610	457	350	200	665	499	381	240
6	450,78	666	499	382	190	732	549	420	240	798	598	458	290
7	498,66	777	583	446	220	854	640	490	280	931	698	534	340
8	546,54	888	666	509	250	976	732	560	320	1.064	798	610	390
9	594,42	999	749	573	280	1.098	823	630	360	1.197	898	687	440
10	642,30	1.110	832	637	310	1.220	915	700	400	1.330	997	763	490
11	690,18	1.221	916	700	340	1.342	1.006	770	440	1.463	1.097	839	540
12	738,06	1.332	999	764	370	1.464	1.098	840	480	1.596	1.197	916	590
13	785,94	1.443	1.082	828	400	1.586	1.189	910	520	1.729	1.297	992	640
14	833,82	1.554	1.165	891	430	1.708	1.281	980	560	1.862	1.396	1.068	690
15	881,70	1.665	1.249	955	460	1.830	1.372	1.050	600	1.995	1.496	1.144	740
16	929,58	1.776	1.332	1.019	490	1.952	1.464	1.120	640	2.128	1.596	1.221	790
17	977,46	1.887	1.415	1.083	520	2.074	1.555	1.190	680	2.261	1.695	1.297	840
18	1.025,34	1.998	1.498	1.146	550	2.196	1.647	1.260	720	2.394	1.795	1.373	890
19	1.073,22	2.109	1.581	1.210	580	2.318	1.738	1.330	760	2.527	1.895	1.450	940
20	1.121,10	2.220	1.665	1.274	610	2.440	1.830	1.400	800	2.660	1.995	1.526	990
21	1.168,98	2.331	1.748	1.337	640	2.562	1.921	1.470	840	2.793	2.094	1.602	1.040
22	1.216,86	2.442	1.831	1.401	670	2.684	2.013	1.540	880	2.926	2.194	1.679	1.090
23	1.264,74	2.553	1.914	1.465	700	2.806	2.104	1.610	920	3.059	2.294	1.755	1.140
24	1.312,62	2.664	1.998	1.528	730	2.928	2.196	1.680	960	3.192	2.394	1.831	1.190
25	1.360,50	2.775	2.081	1.592	760	3.050	2.287	1.750	1.000	3.325	2.493	1.907	1.240
26	1.408,38	2.886	2.164	1.656	790	3.172	2.379	1.820	1.040	3.458	2.593	1.984	1.290
27	1.456,26	2.997	2.247	1.719	820	3.294	2.470	1.890	1.080	3.591	2.693	2.060	1.340
28	1.504,14	3.108	2.331	1.783	850	3.416	2.562	1.960	1.120	3.724	2.793	2.136	1.390
29	1.552,02	3.219	2.414	1.847	880	3.538	2.653	2.030	1.160	3.857	2.892	2.213	1.440
30	1.599,90	3.330	2.497	1.910	910	3.660	2.745	2.100	1.200	3.990	2.992	2.289	1.490
31	1.647,78	3.441	2.580	1.974	940	3.782	2.836	2.170	1.240				
32	1.695,66	3.552	2.664	2.038	970	3.904	2.927	2.240	1.280				
33	1.743,54	3.663	2.747	2.101	1.000	4.026	3.019	2.310	1.320				
34	1.791,42	3.774	2.830	2.165	1.030	4.148	3.110	2.380	1.360				
35	1.839,30	3.885	2.913	2.229	1.060	4.270	3.202	2.450	1.400				
36	1.887,18	3.996	2.996	2.292	1.090	4.392	3.293	2.520	1.440				
37	1.935,06	4.107	3.080	2.356	1.120	4.514	3.385	2.590	1.480				
38	1.982,94	4.218	3.163	2.420	1.150	4.636	3.476	2.660	1.520				
39	2.030,82	4.329	3.246	2.483	1.180								
40	2.078,70	4.440	3.329	2.547	1.210								

Precios para color blanco estándar RAL 9016.

Precios para carta de colores Zehnder +25%. Otros colores, consultar.



# Zehnder Excelsior

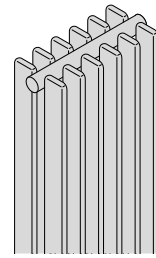
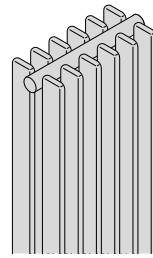
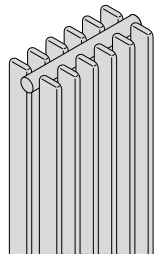
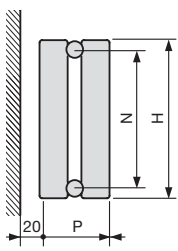

MODELO	E 2200/30	E 2200/40	E 2200/50
Altura H	2000	2000	2000
Entre ejes N	1960	1960	1960
Profundidad P	160	160	160
Distancia entre elementos X	30	40	50
Exponente n	1,31	1,31	1,31

Recuerde pedir el Pack de Conexión

Nº de elementos	Blanco RAL 9016 PVP €	Emisión EN 442 75/65/20 ΔT 50K W	Emisión Caldera condens. ΔT 40K W	Emisión Bomba de calor ΔT 32,5K W	Long. L mm	Emisión EN 442 75/65/20 ΔT 50K W	Emisión Caldera condens. ΔT 40K W	Emisión Bomba de calor ΔT 32,5K W	Long. L mm	Emisión EN 442 75/65/20 ΔT 50K W	Emisión Caldera condens. ΔT 40K W	Emisión Bomba de calor ΔT 32,5K W	Long. L mm
4	644,41	732	546	416	130	816	609	464	160	892	666	507	190
5	740,18	915	683	520	160	1.020	761	580	200	1.115	832	634	240
6	835,95	1.098	820	624	190	1.224	914	696	240	1.338	999	761	290
7	931,72	1.281	956	729	220	1.428	1.066	812	280	1.561	1.165	888	340
8	1.027,49	1.464	1.093	833	250	1.632	1.218	928	320	1.784	1.332	1.015	390
9	1.123,26	1.647	1.230	937	280	1.836	1.371	1.044	360	2.007	1.498	1.141	440
10	1.219,03	1.830	1.366	1.041	310	2.040	1.523	1.160	400	2.230	1.665	1.268	490
11	1.314,80	2.013	1.503	1.145	340	2.244	1.675	1.276	440	2.453	1.831	1.395	540
12	1.410,57	2.196	1.639	1.249	370	2.448	1.828	1.392	480	2.676	1.998	1.522	590
13	1.506,34	2.379	1.776	1.353	400	2.652	1.980	1.508	520	2.899	2.164	1.649	640
14	1.602,11	2.562	1.913	1.457	430	2.856	2.132	1.624	560	3.122	2.331	1.776	690
15	1.697,88	2.745	2.049	1.561	460	3.060	2.284	1.740	600	3.345	2.497	1.902	740
16	1.793,65	2.928	2.186	1.665	490	3.264	2.437	1.856	640	3.568	2.664	2.029	790
17	1.889,42	3.111	2.322	1.769	520	3.468	2.589	1.972	680	3.791	2.830	2.156	840
18	1.985,19	3.294	2.459	1.873	550	3.672	2.741	2.088	720	4.014	2.997	2.283	890
19	2.080,96	3.477	2.596	1.978	580	3.876	2.894	2.204	760	4.237	3.163	2.410	940
20	2.176,73	3.660	2.732	2.082	610	4.080	3.046	2.320	800	4.460	3.330	2.537	990
21	2.272,50	3.843	2.869	2.186	640	4.284	3.198	2.436	840	4.683	3.496	2.663	1.040
22	2.368,27	4.026	3.006	2.290	670	4.488	3.350	2.553	880	4.906	3.662	2.790	1.090
23	2.464,04	4.209	3.142	2.394	700	4.692	3.503	2.669	920	5.129	3.829	2.917	1.140
24	2.559,81	4.392	3.279	2.498	730	4.896	3.655	2.785	960	5.352	3.995	3.044	1.190
25	2.655,58	4.575	3.415	2.602	760	5.100	3.807	2.901	1.000	5.575	4.162	3.171	1.240
26	2.751,35	4.758	3.552	2.706	790	5.304	3.960	3.017	1.040	5.798	4.328	3.298	1.290
27	2.847,12	4.941	3.689	2.810	820	5.508	4.112	3.133	1.080	6.021	4.495	3.424	1.340
28	2.942,89	5.124	3.825	2.914	850	5.712	4.264	3.249	1.120	6.244	4.661	3.551	1.390
29	3.038,66	5.307	3.962	3.018	880	5.916	4.416	3.365	1.160	6.467	4.828	3.678	1.440
30	3.134,43	5.490	4.098	3.122	910	6.120	4.569	3.481	1.200	6.690	4.994	3.805	1.490
31	3.230,20	5.673	4.235	3.226	940	6.324	4.721	3.597	1.240				
32	3.325,97	5.856	4.372	3.331	970	6.528	4.873	3.713	1.280				
33	3.421,74	6.039	4.508	3.435	1.000	6.732	5.026	3.829	1.320				
34	3.517,51	6.222	4.645	3.539	1.030	6.936	5.178	3.945	1.360				
35	3.613,28	6.405	4.782	3.643	1.060	7.140	5.330	4.061	1.400				
36	3.709,05	6.588	4.918	3.747	1.090	7.344	5.483	4.177	1.440				
37	3.804,82	6.771	5.055	3.851	1.120	7.548	5.635	4.293	1.480				
38	3.900,59	6.954	5.191	3.955	1.150	7.752	5.787	4.409	1.520				
39	3.996,36	7.137	5.328	4.059	1.180								
40	4.092,13	7.320	5.465	4.163	1.210								

Precios para color blanco estándar RAL 9016.  
Precios para carta de colores Zehnder +25%. Otros colores, consultar.



# Zehnder Excelsior

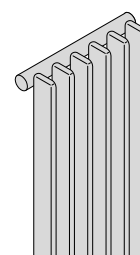
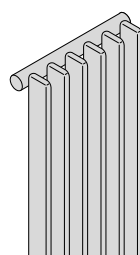
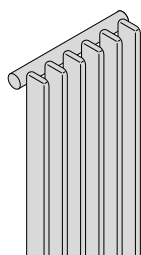
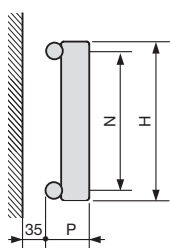

MODELO	E 1220/30	E 1220/40	E 1220/50
Altura H	2200	2200	2200
Entre ejes N	2160	2160	2160
Profundidad P	95	95	95
Distancia entre elementos X	30	40	50
Exponente n	1,29	1,29	1,29

Nº de elementos	Blanco RAL 9016 PVP €	Recuerde pedir el Pack de Conexión											
		Emisión EN 442 75/65/20 ΔT 50K W	Emisión Caldera condens. ΔT 40K W	Emisión Bomba de calor ΔT 32,5K W	Long. L mm	Emisión EN 442 75/65/20 ΔT 50K W	Emisión Caldera condens. ΔT 40K W	Emisión Bomba de calor ΔT 32,5K W	Long. L mm	Emisión EN 442 75/65/20 ΔT 50K W	Emisión Caldera condens. ΔT 40K W	Emisión Bomba de calor ΔT 32,5K W	Long. L mm
4	385,08	492	369	282	130	548	411	314	160	600	450	344	190
5	437,19	615	461	353	160	685	514	393	200	750	562	430	240
6	489,30	738	553	423	190	822	616	472	240	900	675	516	290
7	541,41	861	646	494	220	959	719	550	280	1.050	787	602	340
8	593,52	984	738	564	250	1.096	822	629	320	1.200	900	688	390
9	645,63	1.107	830	635	280	1.233	925	707	360	1.350	1.012	774	440
10	697,74	1.230	922	706	310	1.370	1.027	786	400	1.500	1.125	860	490
11	749,85	1.353	1.015	776	340	1.507	1.130	865	440	1.650	1.237	947	540
12	801,96	1.476	1.107	847	370	1.644	1.233	943	480	1.800	1.350	1.033	590
13	854,07	1.599	1.199	917	400	1.781	1.336	1.022	520	1.950	1.462	1.119	640
14	906,18	1.722	1.291	988	430	1.918	1.438	1.100	560	2.100	1.575	1.205	690
15	958,29	1.845	1.384	1.058	460	2.055	1.541	1.179	600	2.250	1.687	1.291	740
16	1.010,40	1.968	1.476	1.129	490	2.192	1.644	1.257	640	2.400	1.800	1.377	790
17	1.062,51	2.091	1.568	1.200	520	2.329	1.746	1.336	680	2.550	1.912	1.463	840
18	1.114,62	2.214	1.660	1.270	550	2.466	1.849	1.415	720	2.700	2.025	1.549	890
19	1.166,73	2.337	1.752	1.341	580	2.603	1.952	1.493	760	2.850	2.137	1.635	940
20	1.218,84	2.460	1.845	1.411	610	2.740	2.055	1.572	800	3.000	2.250	1.721	990
21	1.270,95	2.583	1.937	1.482	640	2.877	2.157	1.650	840	3.150	2.362	1.807	1.040
22	1.323,06	2.706	2.029	1.552	670	3.014	2.260	1.729	880	3.300	2.475	1.893	1.090
23	1.375,17	2.829	2.121	1.623	700	3.151	2.363	1.808	920	3.450	2.587	1.979	1.140
24	1.427,28	2.952	2.214	1.693	730	3.288	2.466	1.886	960	3.600	2.700	2.065	1.190
25	1.479,39	3.075	2.306	1.764	760	3.425	2.568	1.965	1.000	3.750	2.812	2.151	1.240
26	1.531,50	3.198	2.398	1.835	790	3.562	2.671	2.043	1.040	3.900	2.924	2.237	1.290
27	1.583,61	3.321	2.490	1.905	820	3.699	2.774	2.122	1.080	4.050	3.037	2.323	1.340
28	1.635,72	3.444	2.583	1.976	850	3.836	2.877	2.201	1.120	4.200	3.149	2.409	1.390
29	1.687,83	3.567	2.675	2.046	880	3.973	2.979	2.279	1.160	4.350	3.262	2.495	1.440
30	1.739,94	3.690	2.767	2.117	910	4.110	3.082	2.358	1.200	4.500	3.374	2.581	1.490
31	1.792,05	3.813	2.859	2.187	940	4.247	3.185	2.436	1.240				
32	1.844,16	3.936	2.951	2.258	970	4.384	3.287	2.515	1.280				
33	1.896,27	4.059	3.044	2.329	1.000	4.521	3.390	2.594	1.320				
34	1.948,38	4.182	3.136	2.399	1.030	4.658	3.493	2.672	1.360				
35	2.000,49	4.305	3.228	2.470	1.060	4.795	3.596	2.751	1.400				
36	2.052,60	4.428	3.320	2.540	1.090	4.932	3.698	2.829	1.440				
37	2.104,71	4.551	3.413	2.611	1.120	5.069	3.801	2.908	1.480				
38	2.156,82	4.674	3.505	2.681	1.150	5.206	3.904	2.986	1.520				
39	2.208,93	4.797	3.597	2.752	1.180								
40	2.261,04	4.920	3.689	2.822	1.210								

Precios para color blanco estándar RAL 9016.  
Precios para carta de colores Zehnder +25%. Otros colores, consultar.





# Zehnder Excelsior

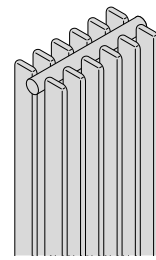
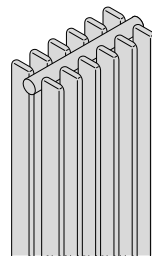
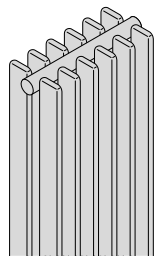
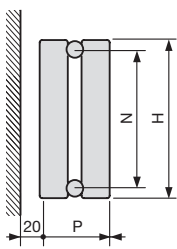

MODELO	E 2220/30	E 2220/40	E 2220/50
Altura H	2200	2200	2200
Entre ejes N	2160	2160	2160
Profundidad P	160	160	160
Distancia entre elementos X	30	40	50
Exponente n	1,31	1,31	1,31

Recuerde pedir el Pack de Conexión

Nº de elementos	Blanco RAL 9016	Emisión EN 442 75/65/20 ΔT 50K W	Emisión Caldera condens. ΔT 40K W	Emisión Bomba de calor ΔT 32,5K W	Long. L mm	Emisión EN 442 75/65/20 ΔT 50K W	Emisión Caldera condens. ΔT 40K W	Emisión Bomba de calor ΔT 32,5K W	Long. L mm	Emisión EN 442 75/65/20 ΔT 50K W	Emisión Caldera condens. ΔT 40K W	Emisión Bomba de calor ΔT 32,5K W	Long. L mm
	PVP €												
4	694,37	804	600	457	130	896	669	510	160	972	726	553	190
5	799,34	1.005	750	572	160	1.120	836	637	200	1.215	907	691	240
6	904,31	1.206	900	686	190	1.344	1.003	764	240	1.458	1.088	829	290
7	1.009,28	1.407	1.050	800	220	1.568	1.171	892	280	1.701	1.270	967	340
8	1.114,25	1.608	1.200	915	250	1.792	1.338	1.019	320	1.944	1.451	1.106	390
9	1.219,22	1.809	1.350	1.029	280	2.016	1.505	1.147	360	2.187	1.633	1.244	440
10	1.324,19	2.010	1.501	1.143	310	2.240	1.672	1.274	400	2.430	1.814	1.382	490
11	1.429,16	2.211	1.651	1.257	340	2.464	1.839	1.401	440	2.673	1.995	1.520	540
12	1.534,13	2.412	1.801	1.372	370	2.688	2.007	1.529	480	2.916	2.177	1.658	590
13	1.639,10	2.613	1.951	1.486	400	2.912	2.174	1.656	520	3.159	2.358	1.797	640
14	1.744,07	2.814	2.101	1.600	430	3.136	2.341	1.784	560	3.402	2.540	1.935	690
15	1.849,04	3.015	2.251	1.715	460	3.360	2.508	1.911	600	3.645	2.721	2.073	740
16	1.954,01	3.216	2.401	1.829	490	3.584	2.676	2.038	640	3.888	2.903	2.211	790
17	2.058,98	3.417	2.551	1.943	520	3.808	2.843	2.166	680	4.131	3.084	2.349	840
18	2.163,95	3.618	2.701	2.058	550	4.032	3.010	2.293	720	4.374	3.265	2.488	890
19	2.268,92	3.819	2.851	2.172	580	4.256	3.177	2.421	760	4.617	3.447	2.626	940
20	2.373,89	4.020	3.001	2.286	610	4.480	3.344	2.548	800	4.860	3.628	2.764	990
21	2.478,86	4.221	3.151	2.401	640	4.704	3.512	2.675	840	5.103	3.810	2.902	1.040
22	2.583,83	4.422	3.301	2.515	670	4.928	3.679	2.803	880	5.346	3.991	3.041	1.090
23	2.688,80	4.623	3.451	2.629	700	5.152	3.846	2.930	920	5.589	4.172	3.179	1.140
24	2.793,77	4.824	3.601	2.744	730	5.376	4.013	3.058	960	5.832	4.354	3.317	1.190
25	2.898,74	5.025	3.751	2.858	760	5.600	4.181	3.185	1.000	6.075	4.535	3.455	1.240
26	3.003,71	5.226	3.901	2.972	790	5.824	4.348	3.312	1.040	6.318	4.717	3.593	1.290
27	3.108,68	5.427	4.051	3.087	820	6.048	4.515	3.440	1.080	6.561	4.898	3.732	1.340
28	3.213,65	5.628	4.201	3.201	850	6.272	4.682	3.567	1.120	6.804	5.079	3.870	1.390
29	3.318,62	5.829	4.352	3.315	880	6.496	4.849	3.695	1.160	7.047	5.261	4.008	1.440
30	3.423,59	6.030	4.502	3.430	910	6.720	5.017	3.822	1.200	7.290	5.442	4.146	1.490
31	3.528,56	6.231	4.652	3.544	940	6.944	5.184	3.949	1.240				
32	3.633,53	6.432	4.802	3.658	970	7.168	5.351	4.077	1.280				
33	3.738,50	6.633	4.952	3.772	1.000	7.392	5.518	4.204	1.320				
34	3.843,47	6.834	5.102	3.887	1.030	7.616	5.686	4.332	1.360				
35	3.948,44	7.035	5.252	4.001	1.060	7.840	5.853	4.459	1.400				
36	4.053,41	7.236	5.402	4.115	1.090	8.064	6.020	4.586	1.440				
37	4.158,38	7.437	5.552	4.230	1.120	8.288	6.187	4.714	1.480				
38	4.263,35	7.638	5.702	4.344	1.150	8.512	6.354	4.841	1.520				
39	4.368,32	7.839	5.852	4.458	1.180								
40	4.473,29	8.040	6.002	4.573	1.210								

Precios para color blanco estándar RAL 9016.  
Precios para carta de colores Zehnder +25%. Otros colores, consultar.



# Zehnder Excelsior

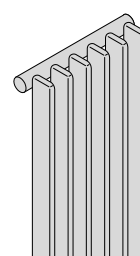
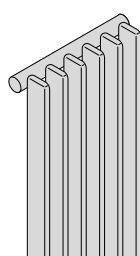
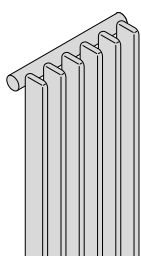
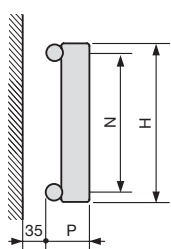

MODELO	E 1250/30	E 1250/40	E 1250/50
Altura H	2500 mm	2500 mm	2500 mm
Entre ejes N	2460 mm	2460 mm	2460 mm
Profundidad P	95 mm	95 mm	95 mm
Distancia entre elementos X	30 mm	40 mm	50 mm
Exponente n	1,29	1,29	1,29

Recuerde pedir el Pack de Conexión

Nº de elementos	Blanco RAL 9016 PVP €	Emisión EN 442 75/65/20			Long. L mm	Emisión Caldera condens. ΔT 40K W			Long. L mm	Emisión Bomba de calor ΔT 32,5K W			Long. L mm
		ΔT 50K W	ΔT 40K W	ΔT 32,5K W		ΔT 50K W	ΔT 40K W	ΔT 32,5K W		ΔT 50K W	ΔT 40K W	ΔT 32,5K W	
4	385,08	572	429	328	130	640	480	367	160	708	531	406	190
5	437,19	715	536	410	160	800	600	459	200	885	664	508	240
6	489,30	858	643	492	190	960	720	551	240	1.062	796	609	290
7	541,41	1.001	751	574	220	1.120	840	643	280	1.239	929	711	340
8	593,52	1.144	858	656	250	1.280	960	734	320	1.416	1.062	812	390
9	645,63	1.287	965	738	280	1.440	1.080	826	360	1.593	1.195	914	440
10	697,74	1.430	1.072	820	310	1.600	1.200	918	400	1.770	1.327	1.015	490
11	749,85	1.573	1.180	902	340	1.760	1.320	1.010	440	1.947	1.460	1.117	540
12	801,96	1.716	1.287	984	370	1.920	1.440	1.101	480	2.124	1.593	1.218	590
13	854,07	1.859	1.394	1.066	400	2.080	1.560	1.193	520	2.301	1.725	1.320	640
14	906,18	2.002	1.501	1.148	430	2.240	1.680	1.285	560	2.478	1.858	1.422	690
15	958,29	2.145	1.608	1.231	460	2.400	1.800	1.377	600	2.655	1.991	1.523	740
16	1.010,40	2.288	1.716	1.313	490	2.560	1.920	1.469	640	2.832	2.124	1.625	790
17	1.062,51	2.431	1.823	1.395	520	2.720	2.040	1.560	680	3.009	2.256	1.726	840
18	1.114,62	2.574	1.930	1.477	550	2.880	2.160	1.652	720	3.186	2.389	1.828	890
19	1.166,73	2.717	2.037	1.559	580	3.040	2.280	1.744	760	3.363	2.522	1.929	940
20	1.218,84	2.860	2.145	1.641	610	3.200	2.400	1.836	800	3.540	2.655	2.031	990
21	1.270,95	3.003	2.252	1.723	640	3.360	2.520	1.928	840	3.717	2.787	2.132	1.040
22	1.323,06	3.146	2.359	1.805	670	3.520	2.640	2.019	880	3.894	2.920	2.234	1.090
23	1.375,17	3.289	2.466	1.887	700	3.680	2.760	2.111	920	4.071	3.053	2.335	1.140
24	1.427,28	3.432	2.574	1.969	730	3.840	2.880	2.203	960	4.248	3.185	2.437	1.190
25	1.479,39	3.575	2.681	2.051	760	4.000	2.999	2.295	1.000	4.425	3.318	2.538	1.240
26	1.531,50	3.718	2.788	2.133	790	4.160	3.119	2.386	1.040	4.602	3.451	2.640	1.290
27	1.583,61	3.861	2.895	2.215	820	4.320	3.239	2.478	1.080	4.779	3.584	2.742	1.340
28	1.635,72	4.004	3.002	2.297	850	4.480	3.359	2.570	1.120	4.956	3.716	2.843	1.390
29	1.687,83	4.147	3.110	2.379	880	4.640	3.479	2.662	1.160	5.133	3.849	2.945	1.440
30	1.739,94	4.290	3.217	2.461	910	4.800	3.599	2.754	1.200	5.310	3.982	3.046	1.490
31	1.792,05	4.433	3.324	2.543	940	4.960	3.719	2.845	1.240				
32	1.844,16	4.576	3.431	2.625	970	5.120	3.839	2.937	1.280				
33	1.896,27	4.719	3.539	2.707	1.000	5.280	3.959	3.029	1.320				
34	1.948,38	4.862	3.646	2.789	1.030	5.440	4.079	3.121	1.360				
35	2.000,49	5.005	3.753	2.871	1.060	5.600	4.199	3.213	1.400				
36	2.052,60	5.148	3.860	2.953	1.090	5.760	4.319	3.304	1.440				
37	2.104,71	5.291	3.968	3.035	1.120	5.920	4.439	3.396	1.480				
38	2.156,82	5.434	4.075	3.117	1.150	6.080	4.559	3.488	1.520				
39	2.208,93	5.577	4.182	3.199	1.180								
40	2.261,04	5.720	4.289	3.281	1.210								

Precios para color blanco estándar RAL 9016.  
Precios para carta de colores Zehnder +25%. Otros colores, consultar.



# Zehnder Excelsior

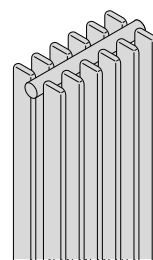
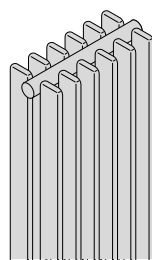
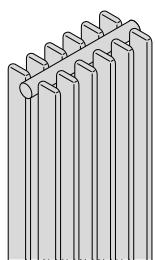
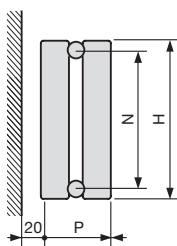

MODELO	E 2250/30	E 2250/40	E 2250/50
Altura H	2500 mm	2500 mm	2500 mm
Entre ejes N	2460 mm	2460 mm	2460 mm
Profundidad P	160 mm	160 mm	160 mm
Distancia entre elementos X	30 mm	40 mm	50 mm
Exponente n	1,31	1,31	1,31

Recuerde pedir el Pack de Conexión

Nº de elementos	Blanco RAL 9016 PVP €	Emisión EN 442 75/65/20				Long. L mm	Emisión Caldera condens. ΔT 40K W				Long. L mm	Emisión Bomba de calor ΔT 32,5K W			
		ΔT 50K W	ΔT 40K W	ΔT 32,5K W	ΔT 50K W		ΔT 40K W	ΔT 32,5K W	ΔT 50K W	ΔT 40K W		ΔT 32,5K W			
4	748,09	912	681	519	130	1.020	761	580	160	1.096	818	623	190		
5	866,49	1.140	851	648	160	1.275	952	725	200	1.370	1.023	779	240		
6	984,89	1.368	1.021	778	190	1.530	1.142	870	240	1.644	1.227	935	290		
7	1.103,29	1.596	1.191	908	220	1.785	1.333	1.015	280	1.918	1.432	1.091	340		
8	1.221,69	1.824	1.362	1.037	250	2.040	1.523	1.160	320	2.192	1.636	1.247	390		
9	1.340,09	2.052	1.532	1.167	280	2.295	1.713	1.305	360	2.466	1.841	1.403	440		
10	1.458,49	2.280	1.702	1.297	310	2.550	1.904	1.450	400	2.740	2.045	1.558	490		
11	1.576,89	2.508	1.872	1.426	340	2.805	2.094	1.595	440	3.014	2.250	1.714	540		
12	1.695,29	2.736	2.043	1.556	370	3.060	2.284	1.740	480	3.288	2.455	1.870	590		
13	1.813,69	2.964	2.213	1.686	400	3.315	2.475	1.885	520	3.562	2.659	2.026	640		
14	1.932,09	3.192	2.383	1.815	430	3.570	2.665	2.030	560	3.836	2.864	2.182	690		
15	2.050,49	3.420	2.553	1.945	460	3.825	2.855	2.175	600	4.110	3.068	2.338	740		
16	2.168,89	3.648	2.723	2.075	490	4.080	3.046	2.320	640	4.384	3.273	2.493	790		
17	2.287,29	3.876	2.894	2.204	520	4.335	3.236	2.466	680	4.658	3.477	2.649	840		
18	2.405,69	4.104	3.064	2.334	550	4.590	3.427	2.611	720	4.932	3.682	2.805	890		
19	2.524,09	4.332	3.234	2.464	580	4.845	3.617	2.756	760	5.206	3.886	2.961	940		
20	2.642,49	4.560	3.404	2.593	610	5.100	3.807	2.901	800	5.480	4.091	3.117	990		
21	2.760,89	4.788	3.574	2.723	640	5.355	3.998	3.046	840	5.754	4.296	3.273	1.040		
22	2.879,29	5.016	3.745	2.853	670	5.610	4.188	3.191	880	6.028	4.500	3.428	1.090		
23	2.997,69	5.244	3.915	2.982	700	5.865	4.378	3.336	920	6.302	4.705	3.584	1.140		
24	3.116,09	5.472	4.085	3.112	730	6.120	4.569	3.481	960	6.576	4.909	3.740	1.190		
25	3.234,49	5.700	4.255	3.242	760	6.375	4.759	3.626	1.000	6.850	5.114	3.896	1.240		
26	3.352,89	5.928	4.425	3.372	790	6.630	4.950	3.771	1.040	7.124	5.318	4.052	1.290		
27	3.471,29	6.156	4.596	3.501	820	6.885	5.140	3.916	1.080	7.398	5.523	4.208	1.340		
28	3.589,69	6.384	4.766	3.631	850	7.140	5.330	4.061	1.120	7.672	5.727	4.363	1.390		
29	3.708,09	6.612	4.936	3.761	880	7.395	5.521	4.206	1.160	7.946	5.932	4.519	1.440		
30	3.826,49	6.840	5.106	3.890	910	7.650	5.711	4.351	1.200	8.220	6.136	4.675	1.490		
31	3.944,89	7.068	5.276	4.020	940	7.905	5.901	4.496	1.240						
32	4.063,29	7.296	5.447	4.150	970	8.160	6.092	4.641	1.280						
33	4.181,69	7.524	5.617	4.279	1.000	8.415	6.282	4.786	1.320						
34	4.300,09	7.752	5.787	4.409	1.030	8.670	6.472	4.931	1.360						
35	4.418,49	7.980	5.957	4.539	1.060	8.925	6.663	5.076	1.400						
36	4.536,89	8.208	6.128	4.668	1.090	9.180	6.853	5.221	1.440						
37	4.655,29	8.436	6.298	4.798	1.120	9.435	7.044	5.366	1.480						
38	4.773,69	8.664	6.468	4.928	1.150	9.690	7.234	5.511	1.520						
39	4.892,09	8.892	6.638	5.057	1.180										
40	5.010,49	9.120	6.808	5.187	1.210										

Precios para color blanco estándar RAL 9016.

Precios para carta de colores Zehnder +25%. Otros colores, consultar.



# Zehnder Excelsior

## FIGURAS DE CONEXIÓN

**Conexiones Bitubo normales.** Sin suplemento de precio.

Misma mano



Cruzados



Lados opuestos



**Conexiones Bitubo especiales.** Con suplemento de precio **58,43 €.**

Desde abajo / hacia abajo



Desde arriba / hacia arriba



**Conexiones Mono-bitubo.** Con suplemento de precio **58,43 €.**

Para válvula Mono-Bitubo de 50 mm  
(Tipos P o Q).

Instalaciones Bitubo; *bypass* cerrado.

Instalaciones Monotubo; *bypass* abierto.

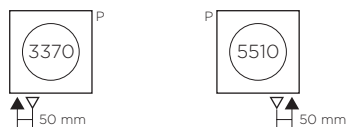

**Conexiones Monotubo.** Con suplemento de precio **58,43 €**

La impulsión (entrada) debe ser por el exterior de la caña.

Válvula Tipo N. Las cañas deben ser lo más largas posibles.

Longitud máxima 26 elementos.

También es posible usar una conexión Mono-Bitubo con la válvula tipo P o Q con el *bypass* abierto.



## MEDIDAS DE RACORES

Otras posiciones de racores, por ejemplo desde arriba hacia arriba, hacia atrás o adelante, pueden suministrarse bajo pedido, con suplemento de precio a consultar.

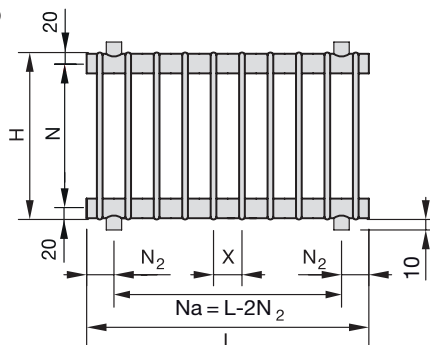

X	30	40	50	60
N <sub>1</sub>	35	40	45	50

X = Distancia entre elementos

# Zehnder Excelsior

## SOPORTES ESTÁNDAR

### Kit de soportes

Soportes a la pared incluidos en el embalaje. En el color del radiador solo con el pedido inicial.

Cada radiador lleva el Kit con su cantidad y tipo necesario de soportes murales. (A la pared).

### Kit de soportes adicional

Al pedir un Kit de soportes adicional hay que indicar para que radiador. Diferentes radiadores usan diferentes kits.

Blanco estándar (RAL 9016)

PVP **54,67 €**



## SOPORTES SOLDADOS

Soldados en fábrica. Solo con el pedido del radiador.

Hasta 0,75 m de altura total, incluyendo la distancia del radiador al suelo, es suficiente con soportes inferiores.

A partir de 0,75 m de altura total es necesario prever soportes en la parte superior del radiador.

En el caso de pedirse soportes a medida, hay que definir las cotas A, B y C.

Recomendamos usar soportes fijos al suelo y soportes variables al techo.

El número y posición de los soportes se define en función de las medidas del radiador. Consultar.



Soportes altura fija modelos simples



Soportes altura fija modelos dobles



Tapa para soportes

Tipo de soportes	Distancia al suelo/techo/pared mm	Referencia	PVP €
<b>Soportes de pie soldados</b>			
Altura fija	100	FF100	<b>92,58</b>
	120	FF120	
Altura regulable	A medida	FFCUS	<b>140,18</b>
	120 - 170	FF170	<b>99,41</b>
	150 - 200	FF200	
	200 - 250	FF250	
	A medida	FFCUS	<b>140,18</b>
<b>Soporte lateral atornillado</b>			
Regulable	60 - 170	RDL/RDR	<b>99,41</b>
<b>Tapa para soportes de pie soldados</b>			
Opcional		753131	<b>44,04</b>

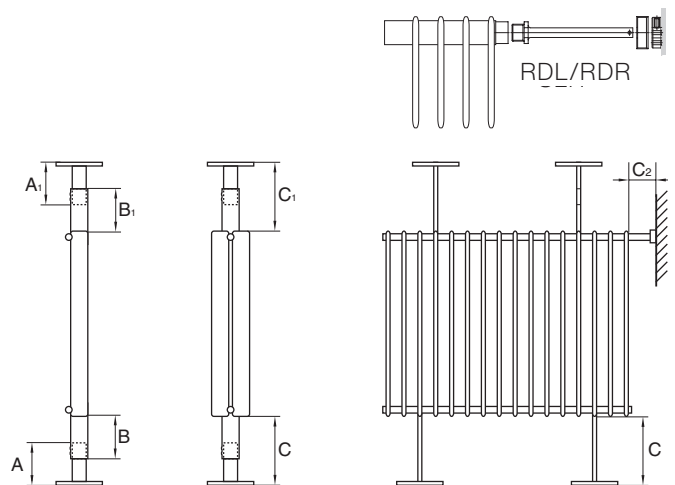

Soportes de altura fija o regulable

# Zehnder Jet X

La revolución del calor





Desde 1981, el clásico del calor al instante. Runtal Jet x, gracias a los 4 mm de distancia entre sus tubos planos y al reducido volumen de agua interior, calienta con rapidez y eficiencia. Y es tan versátil que, si es necesario, se integra en la arquitectura formando curvas o ángulos. Un radiador elegante, un diseño eficiente.



# Zehnder Jet X





# Zehnder Jet X

## VERSIONES Y ACABADOS

Disponible en versiones simples y dobles. Orientación vertical y horizontal (ver páginas 130 y 131). Se suministra en color blanco (RAL 9016).

Disponible en los colores de la carta Zehnder (ver página 10).

Para otros colores o acabados, consultar.

### Ejecuciones especiales

Radiadores en ángulo: modelos VX, VLX, HX y HLX.

Radiadores curvos: modelos VX.

Longitudes o altura especiales.

Posición de racores especial y figuras de conexión distintas (ver página 162).

Alta presión.

Soportes de pie, de empotrar y soldados a consultar.

Todas las ejecuciones especiales deben ser consultadas para verificar disponibilidad y precio.

## SOPORTES

Soportes de pared incluidos en el embalaje. En el color del radiador solo con el pedido inicial.

Otros soportes de pie, de empotrar, soldados, disponibles bajo pedido.

### Kit de soportes a la pared adicional:

Blanco estándar (RAL 9016).

PVP **54,67 €**

## PACK DE CONEXIÓN

Incluye todas las piezas necesarias para la conexión (ver página 257).

### Bitubo. Modelos horizontales:

Para la conexión estándar  
Juego de Válvula + Detentor. Tipo B.



Tipo B

### Monotubo. Modelos horizontales:

Válvula Monotubo Horizontal. Tipo N.

Solo bajo pedido. Necesita que el radiador se fabrique especialmente.

Hay que indicar en el pedido si es derecha o izquierda. (Ver página 162).



Tipo N

### Bitubo y Monotubo. Modelos Verticales:

Válvula Mono-Bitubo de conexión inferior con entre ejes de 50 mm. Instalaciones Bitubo; *bypass* cerrado. Instalaciones Monotubo; *bypass* abierto.

Como estándar se suministra el tipo P (entrada por la derecha). El tipo Q bajo pedido.

La entrada derecha-izquierda no es relevante si la válvula no es termostática.



Tipo P



Tipo Q

Tipo de válvula	Acabado	Regulación manual PVP €	Regulación termostática PVP €
Todos los tipos de válvulas	Todos los acabados	<b>202,59</b>	<b>268,14</b>

# Zehnder Jet X

## ESPECIFICACIONES TÉCNICAS

### Versión horizontal

#### Modelos VX

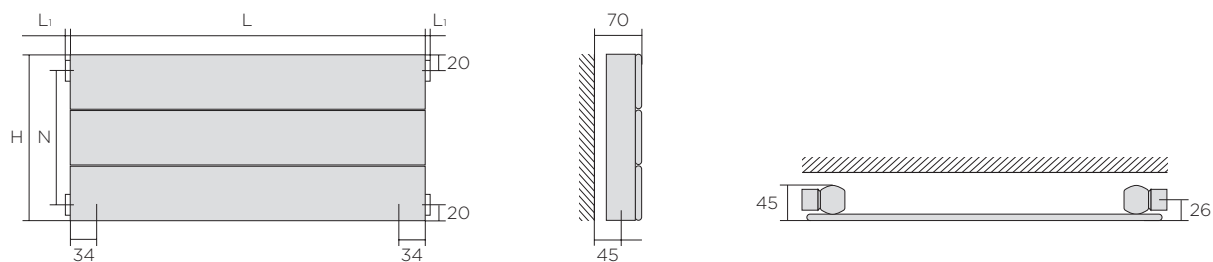

#### Modelos VLX

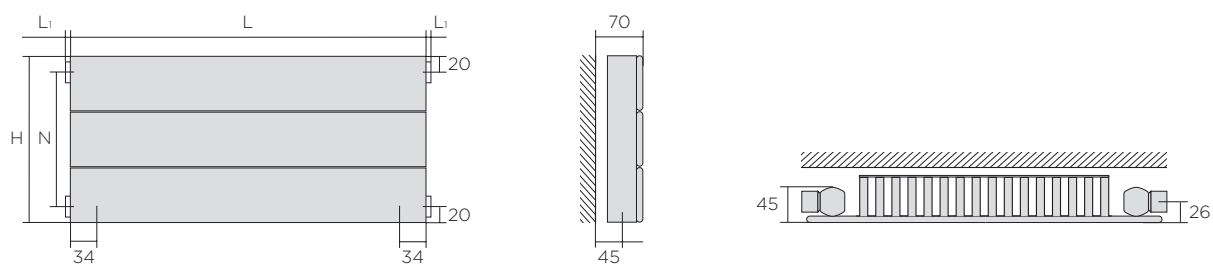

#### Modelos VXA

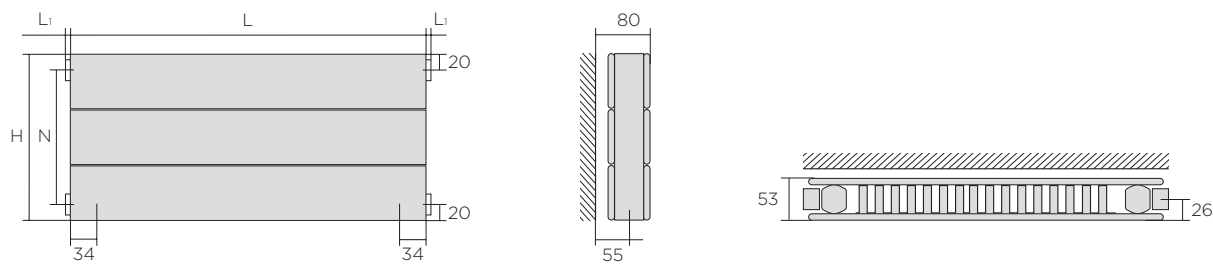

#### Modelos VXD

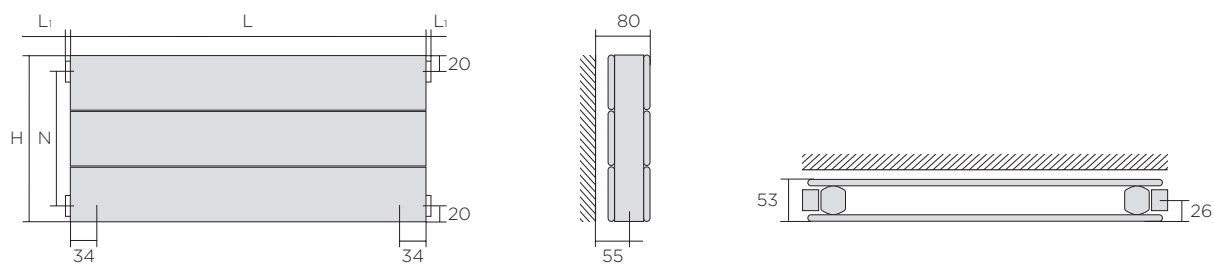

#### Modelos VLX-VX

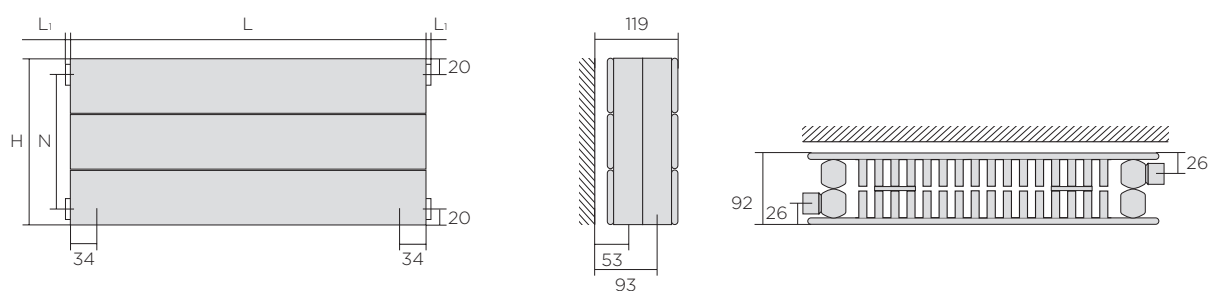

L = Longitud. H = Altura. N = Distancia entre ejes.

# Zehnder Jet X

## ESPECIFICACIONES TÉCNICAS

### Versión vertical

#### Modelos HX

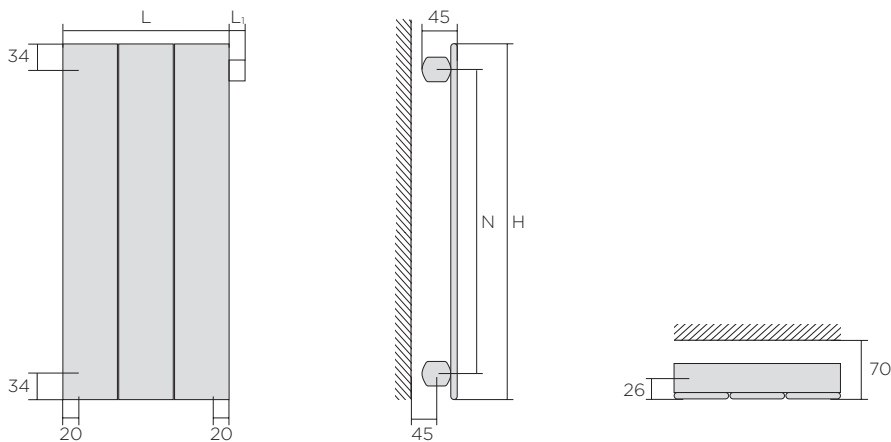

#### Modelos HLX

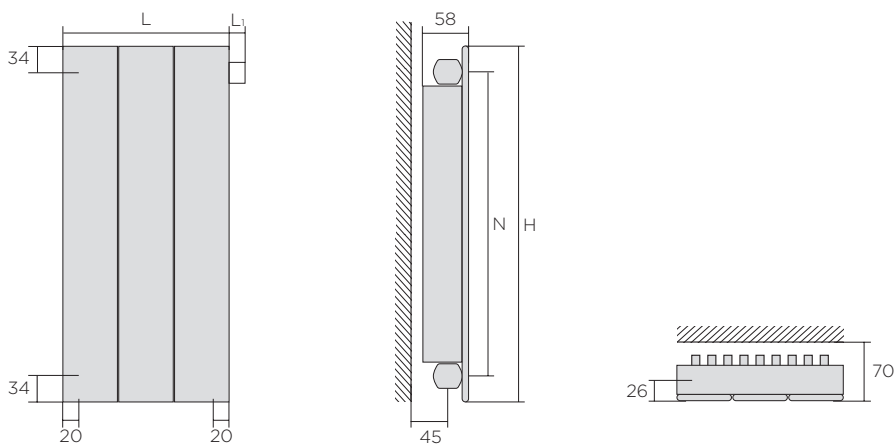

- Tubos ultraplano de acero de 70 x 8 mm. Distancia entre tubos: 4 mm.
- Colectores: tubos hexagonales de acero de 37 x 32 mm.
- Aletas de plancha de acero de 0,5 mm para los modelos aleteados.
- Presión máxima de servicio 4,6 bar. Presión de prueba en fábrica 6 bar.

L = Longitud. H = Altura. N = Distancia entre ejes.

# Zehnder Jet X

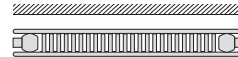
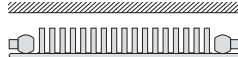
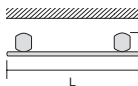

MODELO	NXH14	NXHL14/14	NXHLH14/14
Altura H	144 mm	144 mm	144 mm
Entre ejes N	104 mm	104 mm	104 mm
Profundidad P	45 mm	45 mm	53 mm
Exponente n	1,24	1,23	1,23

Recuerde pedir el Pack de Conexión

Longitud L mm	NXH14				NXHL14/14				NXHLH14/14			
	Emisión EN 442 75/65/20 ΔT 50K W	Emisión Caldera condens. ΔT 40K W	Emisión Bomba de calor ΔT 32,5K W	Blanco RAL 9016 PVP €	Emisión EN 442 75/65/20 ΔT 50K W	Emisión Caldera condens. ΔT 40K W	Emisión Bomba de calor ΔT 32,5K W	Blanco RAL 9016 PVP €	Emisión EN 442 75/65/20 ΔT 50K W	Emisión Caldera condens. ΔT 40K W	Emisión Bomba de calor ΔT 32,5K W	Blanco RAL 9016 PVP €
500	94	71	55	240,18	171	130	100	351,94	225	171	132	498,83
600	112	85	66	250,76	205	155	120	369,12	270	205	159	527,28
700	131	99	77	261,33	239	181	141	386,30	315	239	185	555,72
800	150	113	88	271,91	273	207	161	403,48	360	274	212	584,17
900	168	128	99	282,48	307	233	181	420,67	405	308	238	612,61
1.000	187	142	110	293,06	341	259	201	437,85	450	342	265	641,06
1.100	206	156	121	303,64	375	285	221	455,03	495	376	291	669,51
1.200	224	170	132	314,21	409	311	241	472,22	540	410	318	697,95
1.300	243	184	142	324,79	443	337	261	489,40	585	445	344	726,40
1.400	262	199	153	335,36	477	363	281	506,58	630	479	371	754,84
1.500	281	213	164	345,94	512	389	301	523,77	675	513	397	783,29
1.600	299	227	175	356,52	546	415	321	540,95	720	547	424	811,74
1.700	318	241	186	367,09	580	441	341	558,13	765	581	450	840,18
1.800	337	255	197	377,67	614	466	361	575,31	810	616	477	868,63
1.900	355	269	208	388,24	648	492	381	592,50	855	650	503	897,07
2.000	374	284	219	398,82	682	518	401	609,68	900	684	530	925,52
2.200	411	312	241	419,97	750	570	442	644,05	990	752	583	982,41
2.400	449	340	263	441,12	818	622	482	678,41	1.080	821	636	1.039,30
2.600	486	369	285	462,28	887	674	522	712,78	1.170	889	689	1.096,20
2.800	524	397	307	483,43	955	726	562	747,14	1.260	958	742	1.153,09
3.000	561	425	329	504,58	1.023	777	602	781,51	1.350	1.026	795	1.209,98
3.200	598	454	351	525,73	1.091	829	642	815,88	1.440	1.094	848	1.266,87
3.400	636	482	373	546,88	1.159	881	683	850,24	1.530	1.163	901	1.323,76
3.600	673	510	395	568,04	1.228	933	723	884,61	1.620	1.231	954	1.380,66
3.800	711	539	417	589,19	1.296	985	763	918,97	1.710	1.300	1.007	1.437,55
4.000	748	567	438	610,34	1.364	1.037	803	953,34	1.800	1.368	1.060	1.494,44
4.200	785	596	460	631,49	1.432	1.088	843	987,71	1.890	1.436	1.113	1.551,33
4.400	823	624	482	652,64	1.500	1.140	883	1.022,07	1.980	1.505	1.166	1.608,22
4.600	860	652	504	673,80	1.569	1.192	923	1.056,44	2.070	1.573	1.219	1.665,12
4.800	898	681	526	694,95	1.637	1.244	964	1.090,80	2.160	1.642	1.272	1.722,01
5.000	935	709	548	716,10	1.705	1.296	1.004	1.125,17	2.250	1.710	1.325	1.778,90
5.200	972	737	570	737,25	1.773	1.348	1.044	1.159,54	2.340	1.778	1.378	1.835,79
5.400	1.010	766	592	758,40	1.841	1.399	1.084	1.193,90	2.430	1.847	1.431	1.892,68
5.600	1.047	794	614	779,56	1.910	1.451	1.124	1.228,27	2.520	1.915	1.483	1.949,58
5.800	1.085	822	636	800,71	1.978	1.503	1.164	1.262,63	2.610	1.984	1.536	2.006,47
6.000	1.122	851	658	821,86	2.046	1.555	1.204	1.297,00	2.700	2.052	1.589	2.063,36

Precios para color blanco estándar RAL 9016.

Precios para carta de colores Zehnder +25%. Otros colores, consultar.



# Zehnder Jet X

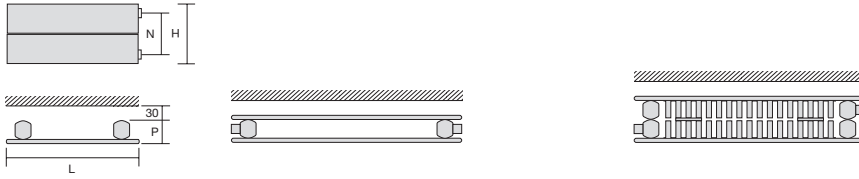

MODELO	NXHH14	NXHLLH14/14
Altura H	144 mm	144 mm
Entre ejes N	104 mm	104 mm
Profundidad P	53 mm	92 mm
Exponente n	1,24	1,24

Recuerde pedir el Pack de Conexión

Longitud L mm	Emisión EN 442 75/65/20 ΔT 50K W	Emisión Caldera condens. ΔT 40K W	Emisión Bomba de calor de calor ΔT 32,5K W	Blanco RAL 9016 PVP €	Emisión EN 442 75/65/20 ΔT 50K W	Emisión Caldera condens. ΔT 40K W	Emisión Bomba de calor de calor ΔT 32,5K W	Blanco RAL 9016 PVP €
500	164	124	96	336,16	334	253	195	704,78
600	196	149	115	357,57	400	303	235	739,12
700	229	174	134	378,97	467	354	274	773,47
800	262	198	153	400,38	534	405	313	807,82
900	294	223	173	421,78	600	455	352	842,17
1.000	327	248	192	443,19	667	506	391	876,52
1.100	360	273	211	464,60	734	556	430	910,87
1.200	392	298	230	486,00	800	607	469	945,22
1.300	425	322	249	507,41	867	658	508	979,57
1.400	458	347	268	528,81	934	708	547	1.013,92
1.500	491	372	288	550,22	1.001	759	586	1.048,27
1.600	523	397	307	571,63	1.067	809	626	1.082,61
1.700	556	422	326	593,03	1.134	860	665	1.116,96
1.800	589	446	345	614,44	1.201	910	704	1.151,31
1.900	621	471	364	635,84	1.267	961	743	1.185,66
2.000	654	496	383	657,25	1.334	1.012	782	1.220,01
2.200	719	546	422	700,06	1.467	1.113	860	1.288,71
2.400	785	595	460	742,87	1.601	1.214	938	1.357,41
2.600	850	645	498	785,69	1.734	1.315	1.017	1.426,10
2.800	916	694	537	828,50	1.868	1.416	1.095	1.494,80
3.000	981	744	575	871,31	2.001	1.517	1.173	1.563,50
3.200	1.046	793	613	914,12	2.134	1.618	1.251	1.632,20
3.400	1.112	843	652	956,93	2.268	1.720	1.329	1.700,90
3.600	1.177	893	690	999,75	2.401	1.821	1.407	1.769,59
3.800	1.243	942	728	1.042,56	2.535	1.922	1.486	1.838,29
4.000	1.308	992	767	1.085,37	2.668	2.023	1.564	1.906,99
4.200	1.373	1.041	805	1.128,18	2.801	2.124	1.642	1.975,69
4.400	1.439	1.091	843	1.170,99	2.935	2.225	1.720	2.044,39
4.600	1.504	1.141	882	1.213,81	3.068	2.327	1.798	2.113,08
4.800	1.570	1.190	920	1.256,62	3.202	2.428	1.877	2.181,78
5.000	1.635	1.240	958	1.299,43	3.335	2.529	1.955	2.250,48
5.200	1.700	1.289	997	1.342,24	3.468	2.630	2.033	2.319,18
5.400	1.766	1.339	1.035	1.385,05	3.602	2.731	2.111	2.387,88
5.600	1.831	1.389	1.073	1.427,87	3.735	2.832	2.189	2.456,57
5.800	1.897	1.438	1.112	1.470,68	3.869	2.933	2.268	2.525,27
6.000	1.962	1.488	1.150	1.513,49	4.002	3.035	2.346	2.593,97

Precios para color blanco estándar RAL 9016.  
Precios para carta de colores Zehnder +25%. Otros colores, consultar.



# Zehnder Jet X

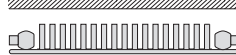
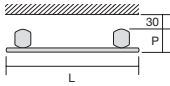
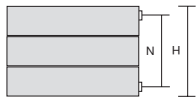

MODELO	NXH21	NXHL21/21	NXHLH21/21
Altura H	218 mm	218 mm	218 mm
Entre ejes N	178 mm	178 mm	178 mm
Profundidad P	45 mm	45 mm	53 mm
Exponente n	1,24	1,24	1,24

Recuerde pedir el Pack de Conexión

Longitud L mm	Emisión EN 442 75/65/20 ΔT 50K W	Emisión Caldera condens. ΔT 40K W	Emisión Bomba de calor ΔT 32,5K W	Blanco RAL 9016 PVP €	Emisión EN 442 75/65/20 ΔT 50K W	Emisión Caldera condens. ΔT 40K W	Emisión Bomba de calor ΔT 32,5K W	Blanco RAL 9016 PVP €	Emisión EN 442 75/65/20 ΔT 50K W	Emisión Caldera condens. ΔT 40K W	Emisión Bomba de calor ΔT 32,5K W	Blanco RAL 9016 PVP €
500	133	100	78	240,18	234	177	137	351,94	305	231	178	503,82
600	159	121	93	250,76	280	212	164	369,12	365	277	214	533,26
700	186	141	109	261,33	327	248	192	386,30	426	323	250	562,70
800	212	161	124	271,91	374	283	219	403,48	487	369	286	592,14
900	239	181	140	282,48	420	319	246	420,67	548	416	321	621,59
1.000	265	201	155	293,06	467	354	274	437,85	609	462	357	651,03
1.100	292	221	171	303,64	514	390	301	455,03	670	508	393	680,47
1.200	318	241	186	314,21	560	425	328	472,22	731	554	428	709,92
1.300	345	261	202	324,79	607	460	356	489,40	792	600	464	739,36
1.400	371	281	217	335,36	654	496	383	506,58	853	647	500	768,80
1.500	398	301	233	345,94	701	531	411	523,77	914	693	535	798,25
1.600	424	322	249	356,52	747	567	438	540,95	974	739	571	827,69
1.700	451	342	264	367,09	794	602	465	558,13	1.035	785	607	857,13
1.800	477	362	280	377,67	841	637	493	575,31	1.096	831	643	886,57
1.900	504	382	295	388,24	887	673	520	592,50	1.157	877	678	916,02
2.000	530	402	311	398,82	934	708	547	609,68	1.218	924	714	945,46
2.200	583	442	342	419,97	1.027	779	602	644,05	1.340	1.016	785	1.004,35
2.400	636	482	373	441,12	1.121	850	657	678,41	1.462	1.108	857	1.063,23
2.600	689	522	404	462,28	1.214	921	712	712,78	1.583	1.201	928	1.122,12
2.800	742	563	435	483,43	1.308	992	766	747,14	1.705	1.293	1.000	1.181,00
3.000	795	603	466	504,58	1.401	1.062	821	781,51	1.827	1.385	1.071	1.239,89
3.200	848	643	497	525,73	1.494	1.133	876	815,88	1.949	1.478	1.142	1.298,78
3.400	901	683	528	546,88	1.588	1.204	931	850,24	2.071	1.570	1.214	1.357,66
3.600	954	723	559	568,04	1.681	1.275	985	884,61	2.192	1.662	1.285	1.416,55
3.800	1.007	764	590	589,19	1.775	1.346	1.040	918,97	2.314	1.755	1.356	1.475,43
4.000	1.060	804	621	610,34	1.868	1.416	1.095	953,34	2.436	1.847	1.428	1.534,32
4.200	1.113	844	652	631,49	1.961	1.487	1.150	987,71	2.558	1.940	1.499	1.593,21
4.400	1.166	884	683	652,64	2.055	1.558	1.204	1.022,07	2.680	2.032	1.571	1.652,09
4.600	1.219	924	715	673,80	2.148	1.629	1.259	1.056,44	2.801	2.124	1.642	1.710,98
4.800	1.272	965	746	694,95	2.242	1.700	1.314	1.090,80	2.923	2.217	1.713	1.769,86
5.000	1.325	1.005	777	716,10	2.335	1.771	1.369	1.125,17	3.045	2.309	1.785	1.828,75
5.200	1.378	1.045	808	737,25	2.428	1.841	1.423	1.159,54	3.167	2.401	1.856	1.887,64
5.400	1.431	1.085	839	758,40	2.522	1.912	1.478	1.193,90	3.289	2.494	1.928	1.946,52
5.600	1.484	1.125	870	779,56	2.615	1.983	1.533	1.228,27	3.410	2.586	1.999	2.005,41
5.800	1.537	1.165	901	800,71	2.709	2.054	1.588	1.262,63	3.532	2.678	2.070	2.064,29
6.000	1.590	1.206	932	821,86	2.802	2.125	1.642	1.297,00	3.654	2.771	2.142	2.123,18

Precios para color blanco estándar RAL 9016.  
Precios para carta de colores Zehnder +25%. Otros colores, consultar.



# Zehnder Jet X

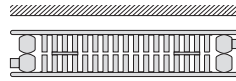
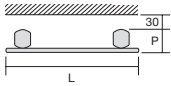
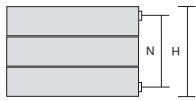

MODELO	NXHH21	NXHLLH21/21
Altura H	218 mm	218 mm
Entre ejes N	178 mm	178 mm
Profundidad P	53 mm	92 mm
Exponente n	1,24	1,28

Recuerde pedir el Pack de Conexión

Longitud L mm	Emisión EN 442 75/65/20 ΔT 50K W	Emisión Caldera condens. ΔT 40K W	Emisión Bomba de calor ΔT 32,5K W	Blanco RAL 9016 PVP €	Emisión EN 442 75/65/20 ΔT 50K W	Emisión Caldera condens. ΔT 40K W	Emisión Bomba de calor ΔT 32,5K W	Blanco RAL 9016 PVP €
500	232	176	136	336,16	458	344	264	704,78
600	278	211	163	357,57	550	413	317	739,12
700	324	246	190	378,97	641	482	369	773,47
800	370	281	217	400,38	733	551	422	807,82
900	417	316	244	421,78	824	620	475	842,17
1.000	463	351	271	443,19	916	688	528	876,52
1.100	509	386	299	464,60	1.008	757	581	910,87
1.200	556	421	326	486,00	1.099	826	633	945,22
1.300	602	456	353	507,41	1.191	895	686	979,57
1.400	648	492	380	528,81	1.282	964	739	1.013,92
1.500	695	527	407	550,22	1.374	1.033	792	1.048,27
1.600	741	562	434	571,63	1.466	1.101	844	1.082,61
1.700	787	597	461	593,03	1.557	1.170	897	1.116,96
1.800	833	632	489	614,44	1.649	1.239	950	1.151,31
1.900	880	667	516	635,84	1.740	1.308	1.003	1.185,66
2.000	926	702	543	657,25	1.832	1.377	1.055	1.220,01
2.200	1.019	772	597	700,06	2.015	1.515	1.161	1.288,71
2.400	1.111	843	651	742,87	2.198	1.652	1.267	1.357,41
2.600	1.204	913	706	785,69	2.382	1.790	1.372	1.426,10
2.800	1.296	983	760	828,50	2.565	1.928	1.478	1.494,80
3.000	1.389	1.053	814	871,31	2.748	2.065	1.583	1.563,50
3.200	1.482	1.123	868	914,12	2.931	2.203	1.689	1.632,20
3.400	1.574	1.194	923	956,93	3.114	2.341	1.794	1.700,90
3.600	1.667	1.264	977	999,75	3.298	2.478	1.900	1.769,59
3.800	1.759	1.334	1.031	1.042,56	3.481	2.616	2.005	1.838,29
4.000	1.852	1.404	1.086	1.085,37	3.664	2.754	2.111	1.906,99
4.200	1.945	1.475	1.140	1.128,18	3.847	2.891	2.217	1.975,69
4.400	2.037	1.545	1.194	1.170,99	4.030	3.029	2.322	2.044,39
4.600	2.130	1.615	1.248	1.213,81	4.214	3.167	2.428	2.113,08
4.800	2.222	1.685	1.303	1.256,62	4.397	3.304	2.533	2.181,78
5.000	2.315	1.755	1.357	1.299,43	4.580	3.442	2.639	2.250,48
5.200	2.408	1.826	1.411	1.342,24	4.763	3.580	2.744	2.319,18
5.400	2.500	1.896	1.466	1.385,05	4.946	3.717	2.850	2.387,88
5.600	2.593	1.966	1.520	1.427,87	5.130	3.855	2.955	2.456,57
5.800	2.685	2.036	1.574	1.470,68	5.313	3.993	3.061	2.525,27
6.000	2.778	2.107	1.628	1.513,49	5.496	4.130	3.166	2.593,97

Precios para color blanco estándar RAL 9016.  
Precios para carta de colores Zehnder +25%. Otros colores, consultar.



# Zehnder Jet X

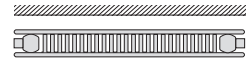
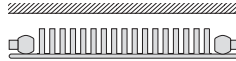
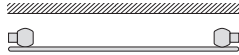
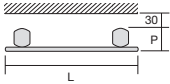
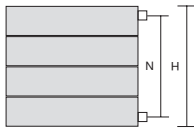

MODELO	NXH28	NXHL28/28	NXHLH28/28
Altura H	292 mm	292 mm	292 mm
Entre ejes N	252 mm	252 mm	252 mm
Profundidad P	45 mm	45 mm	53 mm
Exponente n	1,24	1,25	1,26

Recuerde pedir el Pack de Conexión

Longitud L mm	NXH28				NXHL28/28				NXHLH28/28			
	Emisión EN 442 75/65/20 ΔT 50K W	Emisión Caldera condens. ΔT 40K W	Emisión Bomba de calor ΔT 32,5K W	Blanco RAL 9016 PVP €	Emisión EN 442 75/65/20 ΔT 50K W	Emisión Caldera condens. ΔT 40K W	Emisión Bomba de calor ΔT 32,5K W	Blanco RAL 9016 PVP €	Emisión EN 442 75/65/20 ΔT 50K W	Emisión Caldera condens. ΔT 40K W	Emisión Bomba de calor ΔT 32,5K W	Blanco RAL 9016 PVP €
500	171	130	100	276,96	286	216	167	392,88	353	266	205	586,28
600	205	156	120	290,44	343	260	200	414,03	424	320	246	622,22
700	239	182	140	303,93	400	303	234	435,18	494	373	287	658,16
800	274	207	160	317,42	458	346	267	456,32	565	426	328	694,10
900	308	233	180	330,90	515	389	300	477,47	635	480	369	730,05
1.000	342	259	200	344,39	572	433	334	498,62	706	533	410	765,99
1.100	376	285	221	357,88	629	476	367	519,77	777	586	451	801,93
1.200	410	311	241	371,36	686	519	401	540,92	847	640	492	837,88
1.300	445	337	261	384,85	744	563	434	562,06	918	693	533	873,82
1.400	479	363	281	398,34	801	606	467	583,21	988	746	574	909,76
1.500	513	389	301	411,83	858	649	501	604,36	1.059	799	615	945,71
1.600	547	415	321	425,31	915	692	534	625,51	1.130	853	656	981,65
1.700	581	441	341	438,80	972	736	568	646,66	1.200	906	697	1.017,59
1.800	616	467	361	452,29	1.030	779	601	667,80	1.271	959	738	1.053,53
1.900	650	493	381	465,77	1.087	822	634	688,95	1.341	1.013	780	1.089,48
2.000	684	519	401	479,26	1.144	866	668	710,10	1.412	1.066	821	1.125,42
2.200	752	571	441	506,23	1.258	952	734	752,40	1.553	1.173	903	1.197,31
2.400	821	622	481	533,21	1.373	1.039	801	794,69	1.694	1.279	985	1.269,19
2.600	889	674	521	560,18	1.487	1.125	868	836,99	1.836	1.386	1.067	1.341,08
2.800	958	726	561	587,16	1.602	1.212	935	879,28	1.977	1.492	1.149	1.412,96
3.000	1.026	778	601	614,13	1.716	1.298	1.002	921,58	2.118	1.599	1.231	1.484,85
3.200	1.094	830	641	641,10	1.830	1.385	1.068	963,88	2.259	1.705	1.313	1.556,74
3.400	1.163	882	682	668,08	1.945	1.471	1.135	1.006,17	2.400	1.812	1.395	1.628,62
3.600	1.231	934	722	695,05	2.059	1.558	1.202	1.048,47	2.542	1.919	1.477	1.700,51
3.800	1.300	985	762	722,03	2.174	1.645	1.269	1.090,76	2.683	2.025	1.559	1.772,39
4.000	1.368	1.037	802	749,00	2.288	1.731	1.335	1.133,06	2.824	2.132	1.641	1.844,28
4.200	1.436	1.089	842	775,97	2.402	1.818	1.402	1.175,36	2.965	2.238	1.723	1.916,17
4.400	1.505	1.141	882	802,95	2.517	1.904	1.469	1.217,65	3.106	2.345	1.805	1.988,05
4.600	1.573	1.193	922	829,92	2.631	1.991	1.536	1.259,95	3.248	2.452	1.887	2.059,94
4.800	1.642	1.245	962	856,90	2.746	2.077	1.602	1.302,24	3.389	2.558	1.969	2.131,82
5.000	1.710	1.297	1.002	883,87	2.860	2.164	1.669	1.344,54	3.530	2.665	2.051	2.203,71
5.200	1.778	1.349	1.042	910,84	2.974	2.250	1.736	1.386,84	3.671	2.771	2.133	2.275,60
5.400	1.847	1.400	1.083	937,82	3.089	2.337	1.803	1.429,13	3.812	2.878	2.215	2.347,48
5.600	1.915	1.452	1.123	964,79	3.203	2.424	1.870	1.471,43	3.954	2.985	2.298	2.419,37
5.800	1.984	1.504	1.163	991,77	3.318	2.510	1.936	1.513,72	4.095	3.091	2.380	2.491,25
6.000	2.052	1.556	1.203	1.018,74	3.432	2.597	2.003	1.556,02	4.236	3.198	2.462	2.563,14

Precios para color blanco estándar RAL 9016.  
Precios para carta de colores Zehnder +25%. Otros colores, consultar.





# Zehnder Jet X

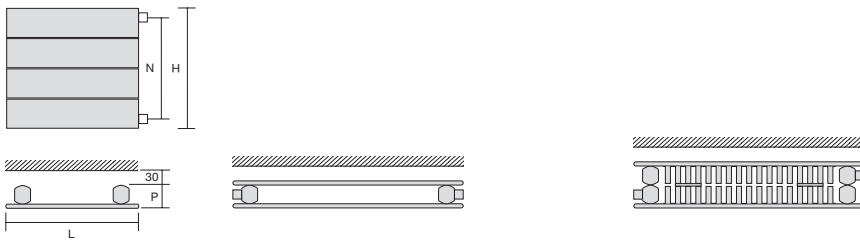

MODELO	NXHH28	NXHLLH28/28
Altura H	292 mm	292 mm
Entre ejes N	252 mm	252 mm
Profundidad P	53 mm	92 mm
Exponente n	1,25	1,31

Recuerde pedir el Pack de Conexión

Longitud L mm	Emisión EN 442 75/65/20 $\Delta T$ 50K W	Emisión Caldera condens. $\Delta T$ 40K W	Emisión Bomba de calor $\Delta T$ 32,5K W	Blanco RAL 9016 PVP €	Emisión EN 442 75/65/20 $\Delta T$ 50K W	Emisión Caldera condens. $\Delta T$ 40K W	Emisión Bomba de calor $\Delta T$ 32,5K W	Blanco RAL 9016 PVP €
500	297	224	173	396,99	567	423	322	789,32
600	356	269	208	424,21	680	508	387	831,59
700	415	314	242	451,43	794	593	451	873,87
800	474	359	277	478,65	907	677	516	916,14
900	534	404	311	505,87	1.021	762	580	958,42
1.000	593	449	346	533,09	1.134	847	645	1.000,69
1.100	652	494	381	560,31	1.247	931	709	1.042,97
1.200	712	538	415	587,53	1.361	1.016	774	1.085,24
1.300	771	583	450	614,75	1.474	1.101	838	1.127,52
1.400	830	628	485	641,97	1.588	1.185	903	1.169,79
1.500	890	673	519	669,20	1.701	1.270	967	1.212,07
1.600	949	718	554	696,42	1.814	1.355	1.032	1.254,34
1.700	1.008	763	588	723,64	1.928	1.439	1.096	1.296,62
1.800	1.067	808	623	750,86	2.041	1.524	1.161	1.338,89
1.900	1.127	852	658	778,08	2.155	1.608	1.225	1.381,17
2.000	1.186	897	692	805,30	2.268	1.693	1.290	1.423,44
2.200	1.305	987	761	859,74	2.495	1.862	1.419	1.507,99
2.400	1.423	1.077	831	914,18	2.722	2.032	1.548	1.592,54
2.600	1.542	1.167	900	968,63	2.948	2.201	1.677	1.677,09
2.800	1.660	1.256	969	1.023,07	3.175	2.370	1.806	1.761,64
3.000	1.779	1.346	1.038	1.077,51	3.402	2.540	1.935	1.846,19
3.200	1.898	1.436	1.108	1.131,95	3.629	2.709	2.064	1.930,74
3.400	2.016	1.525	1.177	1.186,39	3.856	2.878	2.193	2.015,29
3.600	2.135	1.615	1.246	1.240,84	4.082	3.048	2.322	2.099,84
3.800	2.253	1.705	1.315	1.295,28	4.309	3.217	2.451	2.184,39
4.000	2.372	1.795	1.384	1.349,72	4.536	3.386	2.580	2.268,94
4.200	2.491	1.884	1.454	1.404,16	4.763	3.556	2.709	2.353,49
4.400	2.609	1.974	1.523	1.458,60	4.990	3.725	2.838	2.438,04
4.600	2.728	2.064	1.592	1.513,05	5.216	3.894	2.967	2.522,59
4.800	2.846	2.154	1.661	1.567,49	5.443	4.064	3.096	2.607,14
5.000	2.965	2.243	1.730	1.621,93	5.670	4.233	3.225	2.691,69
5.200	3.084	2.333	1.800	1.676,37	5.897	4.402	3.354	2.779,24
5.400	3.202	2.423	1.869	1.730,81	6.124	4.571	3.483	2.860,79
5.600	3.321	2.512	1.938	1.785,26	6.350	4.741	3.612	2.945,34
5.800	3.439	2.602	2.007	1.839,70	6.577	4.910	3.741	3.029,89
6.000	3.558	2.692	2.077	1.894,14	6.804	5.079	3.870	3.114,44

Precios para color blanco estándar RAL 9016.  
Precios para carta de colores Zehnder +25%. Otros colores, consultar.



# Zehnder Jet X

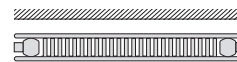
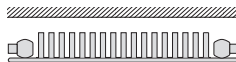
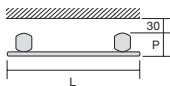
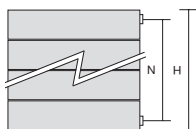

MODELO	NXH35	NXHL35/35	NXHLH35/35
Altura H	366 mm	366 mm	366 mm
Entre ejes N	326 mm	326 mm	326 mm
Profundidad P	45 mm	60 mm	53 mm
Exponente n	1,24	1,28	1,27

Recuerde pedir el Pack de Conexión

Longitud L mm	Emisión EN 442 75/65/20 ΔT 50K W	Emisión Caldera condens. ΔT 40K W	Emisión Bomba de calor ΔT 32,5K W	Blanco RAL 9016 PVP €	Emisión EN 442 75/65/20 ΔT 50K W	Emisión Caldera condens. ΔT 40K W	Emisión Bomba de calor ΔT 32,5K W	Blanco RAL 9016 PVP €	Emisión EN 442 75/65/20 ΔT 50K W	Emisión Caldera condens. ΔT 40K W	Emisión Bomba de calor ΔT 32,5K W	Blanco RAL 9016 PVP €
500	209	158	123	313,67	376	283	217	433,82	435	327	251	671,09
600	251	190	147	330,07	451	339	260	458,93	521	393	302	714,00
700	293	222	172	346,46	526	396	303	484,04	608	458	352	756,91
800	334	254	196	362,86	602	452	347	509,15	695	524	402	799,82
900	376	285	221	379,25	677	509	390	534,26	782	589	453	842,74
1.000	418	317	245	395,65	752	565	433	559,37	869	655	503	885,65
1.100	460	349	270	412,05	827	622	477	584,48	956	720	553	928,56
1.200	502	380	294	428,44	902	678	520	609,59	1.043	785	603	971,48
1.300	543	412	319	444,84	978	735	563	634,70	1.130	851	654	1.014,39
1.400	585	444	343	461,23	1.053	791	607	659,81	1.217	916	704	1.057,30
1.500	627	475	368	477,63	1.128	848	650	684,93	1.304	982	754	1.100,22
1.600	669	507	392	494,03	1.203	904	693	710,04	1.390	1.047	805	1.143,13
1.700	711	539	417	510,42	1.278	961	737	735,15	1.477	1.113	855	1.186,04
1.800	752	571	441	526,82	1.354	1.017	780	760,26	1.564	1.178	905	1.228,95
1.900	794	602	466	543,21	1.429	1.074	823	785,37	1.651	1.244	955	1.271,87
2.000	836	634	490	559,61	1.504	1.130	867	810,48	1.738	1.309	1.006	1.314,78
2.200	920	697	539	592,40	1.654	1.243	953	860,70	1.912	1.440	1.106	1.400,61
2.400	1.003	761	588	625,19	1.805	1.356	1.040	910,92	2.086	1.571	1.207	1.486,43
2.600	1.087	824	637	657,99	1.955	1.469	1.126	961,15	2.259	1.702	1.307	1.572,26
2.800	1.170	887	686	690,78	2.106	1.582	1.213	1.011,37	2.433	1.833	1.408	1.658,08
3.000	1.254	951	735	723,57	2.256	1.695	1.300	1.061,59	2.607	1.964	1.508	1.743,91
3.200	1.338	1.014	784	756,36	2.406	1.809	1.386	1.111,81	2.781	2.095	1.609	1.829,74
3.400	1.421	1.078	833	789,15	2.557	1.922	1.473	1.162,03	2.955	2.225	1.710	1.915,56
3.600	1.505	1.141	882	821,95	2.707	2.035	1.560	1.212,26	3.128	2.356	1.810	2.001,39
3.800	1.588	1.204	931	854,74	2.858	2.148	1.646	1.262,48	3.302	2.487	1.911	2.087,21
4.000	1.672	1.268	980	887,53	3.008	2.261	1.733	1.312,70	3.476	2.618	2.011	2.173,04
4.200	1.756	1.331	1.029	920,32	3.158	2.374	1.820	1.362,92	3.650	2.749	2.112	2.258,87
4.400	1.839	1.395	1.078	953,11	3.309	2.487	1.906	1.413,14	3.824	2.880	2.212	2.344,69
4.600	1.923	1.458	1.127	985,91	3.459	2.600	1.993	1.463,37	3.997	3.011	2.313	2.430,52
4.800	2.006	1.521	1.176	1.018,70	3.610	2.713	2.080	1.513,59	4.171	3.142	2.414	2.516,34
5.000	2.090	1.585	1.225	1.051,49	3.760	2.826	2.166	1.563,81	4.345	3.273	2.514	2.602,17
5.200	2.174	1.648	1.274	1.084,28	3.910	2.939	2.253	1.614,03	4.519	3.404	2.615	2.688,00
5.400	2.257	1.712	1.323	1.117,07	4.061	3.052	2.340	1.664,25	4.693	3.535	2.715	2.773,82
5.600	2.341	1.775	1.372	1.149,87	4.211	3.165	2.426	1.714,48	4.866	3.665	2.816	2.859,65
5.800	2.424	1.838	1.421	1.182,66	4.362	3.278	2.513	1.764,70	5.040	3.796	2.916	2.945,47
6.000	2.508	1.902	1.470	1.215,45	4.512	3.391	2.600	1.814,92	5.214	3.927	3.017	3.031,30

Precios para color blanco estándar RAL 9016.

Precios para carta de colores Zehnder +25%. Otros colores, consultar.



# Zehnder Jet X

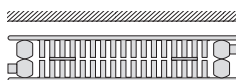
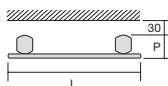
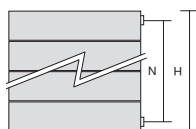

MODELO	NXHH35	NXLLH35/35
Altura H	366 mm	366 mm
Entre ejes N	326 mm	326 mm
Profundidad P	53 mm	92 mm
Exponente n	1,26	1,33

Recuerde pedir el Pack de Conexión

Longitud L mm	Emisión EN 442 75/65/20 ΔT 50K W	Emisión Caldera condens. ΔT 40K W	Emisión Bomba de calor ΔT 32,5K W	Blanco RAL 9016 PVP €	Emisión EN 442 75/65/20 ΔT 50K W	Emisión Caldera condens. ΔT 40K W	Emisión Bomba de calor ΔT 32,5K W	Blanco RAL 9016 PVP €
500	361	272	209	457,80	665	494	375	873,91
600	433	327	251	490,83	798	593	450	924,11
700	505	381	293	523,87	931	692	525	974,31
800	577	435	335	556,90	1.064	791	600	1.024,52
900	649	490	377	589,94	1.197	890	675	1.074,72
1.000	721	544	419	622,97	1.330	988	750	1.124,92
1.100	793	599	461	656,01	1.463	1.087	825	1.175,12
1.200	865	653	503	689,04	1.596	1.186	900	1.225,32
1.300	937	708	545	722,08	1.729	1.285	975	1.275,53
1.400	1.009	762	587	755,11	1.862	1.384	1.050	1.325,73
1.500	1.082	816	628	788,15	1.995	1.483	1.125	1.375,93
1.600	1.154	871	670	821,18	2.128	1.582	1.200	1.426,13
1.700	1.226	925	712	854,22	2.261	1.680	1.275	1.476,33
1.800	1.298	980	754	887,25	2.394	1.779	1.350	1.526,54
1.900	1.370	1.034	796	920,29	2.527	1.878	1.425	1.576,74
2.000	1.442	1.089	838	953,32	2.660	1.977	1.500	1.626,94
2.200	1.586	1.197	922	1.019,39	2.926	2.175	1.650	1.727,34
2.400	1.730	1.306	1.006	1.085,46	3.192	2.372	1.800	1.827,75
2.600	1.875	1.415	1.089	1.151,53	3.458	2.570	1.950	1.928,15
2.800	2.019	1.524	1.173	1.217,60	3.724	2.768	2.100	2.028,56
3.000	2.163	1.633	1.257	1.283,67	3.990	2.965	2.250	2.128,96
3.200	2.307	1.742	1.341	1.349,74	4.256	3.163	2.400	2.229,36
3.400	2.451	1.851	1.425	1.415,81	4.522	3.361	2.550	2.329,77
3.600	2.596	1.959	1.508	1.481,88	4.788	3.558	2.700	2.430,17
3.800	2.740	2.068	1.592	1.547,95	5.054	3.756	2.850	2.530,58
4.000	2.884	2.177	1.676	1.614,02	5.320	3.954	3.000	2.630,98
4.200	3.028	2.286	1.760	1.680,09	5.586	4.152	3.150	2.731,38
4.400	3.172	2.395	1.844	1.746,16	5.852	4.349	3.300	2.831,79
4.600	3.317	2.504	1.927	1.812,23	6.118	4.547	3.450	2.932,19
4.800	3.461	2.613	2.011	1.878,30	6.384	4.745	3.600	3.032,60
5.000	3.605	2.721	2.095	1.944,37	6.650	4.942	3.750	3.133,00
5.200	3.749	2.830	2.179	2.010,44	6.916	5.140	3.900	3.233,40
5.400	3.893	2.939	2.263	2.076,51	7.182	5.338	4.050	3.333,81
5.600	4.038	3.048	2.346	2.142,58	7.448	5.535	4.200	3.434,21
5.800	4.182	3.157	2.430	2.208,65	7.714	5.733	4.350	3.534,62
6.000	4.326	3.266	2.514	2.274,72	7.980	5.931	4.500	3.635,02

Precios para color blanco estándar RAL 9016.

Precios para carta de colores Zehnder +25%. Otros colores, consultar.



# Zehnder Jet X

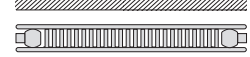
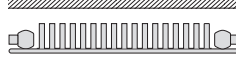
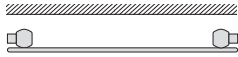
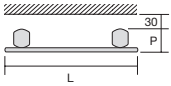
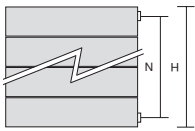

MODELO	NXH42	NXHL42/42	NXHLH42/42
Altura H	440 mm	440 mm	440 mm
Entre ejes N	400 mm	400 mm	400 mm
Profundidad P	45 mm	60 mm	53 mm
Exponente n	1,24	1,29	1,29

Recuerde pedir el Pack de Conexión

Longitud L	Emisión EN 442 75/65/20 ΔT 50K W	Emisión Caldera condens. ΔT 40K W	Emisión Bomba de calor ΔT 32,5K W	Blanco RAL 9016 PVP €	Emisión EN 442 75/65/20 ΔT 50K W	Emisión Caldera condens. ΔT 40K W	Emisión Bomba de calor ΔT 32,5K W	Blanco RAL 9016 PVP €	Emisión EN 442 75/65/20 ΔT 50K W	Emisión Caldera condens. ΔT 40K W	Emisión Bomba de calor ΔT 32,5K W	Blanco RAL 9016 PVP €
500	248	188	145	350,42	431	323	247	474,78	494	370	283	751,04
600	297	225	174	369,72	517	387	296	503,86	592	444	340	799,96
700	347	263	203	389,03	603	452	346	532,94	691	518	396	848,88
800	396	300	232	408,33	689	517	395	562,01	790	592	453	897,80
900	446	338	261	427,64	775	581	445	591,09	888	666	510	946,72
1.000	495	375	290	446,94	861	646	494	620,17	987	740	566	995,64
1.100	545	413	319	466,25	947	710	543	649,25	1.086	814	623	1.044,56
1.200	594	450	348	485,55	1.033	775	593	678,33	1.184	888	679	1.093,48
1.300	644	488	377	504,86	1.119	839	642	707,40	1.283	962	736	1.142,40
1.400	693	525	406	524,16	1.205	904	691	736,48	1.382	1.036	793	1.191,32
1.500	743	563	435	543,47	1.292	968	741	765,56	1.481	1.110	849	1.240,25
1.600	792	601	464	562,77	1.378	1.033	790	794,64	1.579	1.184	906	1.289,17
1.700	842	638	493	582,08	1.464	1.098	840	823,72	1.678	1.258	963	1.338,09
1.800	891	676	522	601,38	1.550	1.162	889	852,79	1.777	1.332	1.019	1.387,01
1.900	941	713	551	620,69	1.636	1.227	938	881,87	1.875	1.406	1.076	1.435,93
2.000	990	751	580	639,99	1.722	1.291	988	910,95	1.974	1.480	1.132	1.484,85
2.200	1.089	826	638	678,60	1.894	1.420	1.087	969,11	2.171	1.628	1.246	1.582,69
2.400	1.188	901	696	717,21	2.066	1.550	1.185	1.027,26	2.369	1.776	1.359	1.680,53
2.600	1.287	976	754	755,82	2.239	1.679	1.284	1.085,42	2.566	1.924	1.472	1.778,38
2.800	1.386	1.051	812	794,43	2.411	1.808	1.383	1.143,57	2.764	2.072	1.585	1.876,22
3.000	1.485	1.126	870	833,04	2.583	1.937	1.482	1.201,73	2.961	2.220	1.699	1.974,06
3.200	1.584	1.201	928	871,65	2.755	2.066	1.581	1.259,89	3.158	2.368	1.812	2.071,90
3.400	1.683	1.276	986	910,26	2.927	2.195	1.679	1.318,04	3.356	2.516	1.925	2.169,74
3.600	1.782	1.351	1.045	948,87	3.100	2.324	1.778	1.376,20	3.553	2.664	2.038	2.267,59
3.800	1.881	1.426	1.103	987,48	3.272	2.453	1.877	1.434,35	3.751	2.812	2.152	2.365,43
4.000	1.980	1.501	1.161	1.026,09	3.444	2.583	1.976	1.492,51	3.948	2.960	2.265	2.463,27
4.200	2.079	1.576	1.219	1.064,70	3.616	2.712	2.074	1.550,67	4.145	3.109	2.378	2.561,11
4.400	2.178	1.652	1.277	1.103,31	3.788	2.841	2.173	1.608,82	4.343	3.257	2.491	2.658,95
4.600	2.277	1.727	1.335	1.141,92	3.961	2.970	2.272	1.666,98	4.540	3.405	2.605	2.756,80
4.800	2.376	1.802	1.393	1.180,53	4.133	3.099	2.371	1.725,13	4.738	3.553	2.718	2.854,64
5.000	2.475	1.877	1.451	1.219,14	4.305	3.228	2.470	1.783,29	4.935	3.701	2.831	2.952,48
5.200	2.574	1.952	1.509	1.257,75	4.477	3.357	2.568	1.841,45	5.132	3.849	2.944	3.050,32
5.400	2.673	2.027	1.567	1.296,36	4.649	3.486	2.667	1.899,60	5.330	3.997	3.058	3.148,16
5.600	2.772	2.102	1.625	1.334,97	4.822	3.616	2.766	1.957,76	5.527	4.145	3.171	3.246,01
5.800	2.871	2.177	1.683	1.373,58	4.994	3.745	2.865	2.015,91	5.725	4.293	3.284	3.343,85
6.000	2.970	2.252	1.741	1.412,19	5.166	3.874	2.964	2.074,07	5.922	4.441	3.397	3.441,69

Precios para color blanco estándar RAL 9016.

Precios para carta de colores Zehnder +25%. Otros colores, consultar.



# Zehnder Jet X

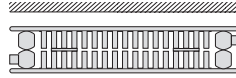
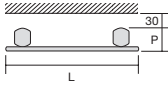
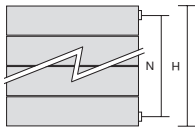

MODELO	NXHH42	NXLLH42/42
Altura H	440 mm	440 mm
Entre ejes N	400 mm	400 mm
Profundidad P	53 mm	92 mm
Exponente n	1,26	1,35

Recuerde pedir el Pack de Conexión

Longitud L mm	Emisión EN 442 75/65/20 ΔT 50K W	Emisión Caldera condens. ΔT 40K W	Emisión Bomba de calor ΔT 32,5K W	Blanco RAL 9016 PVP €	Emisión EN 442 75/65/20 ΔT 50K W	Emisión Caldera condens. ΔT 40K W	Emisión Bomba de calor ΔT 32,5K W	Blanco RAL 9016 PVP €
500	424	320	246	518,57	757	560	423	958,49
600	508	384	295	557,42	908	672	507	1.016,61
700	593	448	345	596,26	1.059	784	592	1.074,74
800	678	512	394	635,11	1.210	896	677	1.132,86
900	762	575	443	673,95	1.362	1.008	761	1.190,99
1.000	847	639	492	712,80	1.513	1.119	846	1.249,11
1.100	932	703	541	751,65	1.664	1.231	930	1.307,23
1.200	1.016	767	591	790,49	1.816	1.343	1.015	1.365,36
1.300	1.101	831	640	829,34	1.967	1.455	1.100	1.423,48
1.400	1.186	895	689	868,18	2.118	1.567	1.184	1.481,61
1.500	1.271	959	738	907,03	2.270	1.679	1.269	1.539,73
1.600	1.355	1.023	788	945,88	2.421	1.791	1.353	1.597,85
1.700	1.440	1.087	837	984,72	2.572	1.903	1.438	1.655,98
1.800	1.525	1.151	886	1.023,57	2.723	2.015	1.522	1.714,10
1.900	1.609	1.215	935	1.062,41	2.875	2.127	1.607	1.772,23
2.000	1.694	1.279	984	1.101,26	3.026	2.239	1.692	1.830,35
2.200	1.863	1.407	1.083	1.178,95	3.329	2.463	1.861	1.946,60
2.400	2.033	1.535	1.181	1.256,64	3.631	2.687	2.030	2.062,85
2.600	2.202	1.662	1.280	1.334,34	3.934	2.911	2.199	2.179,09
2.800	2.372	1.790	1.378	1.412,03	4.236	3.135	2.368	2.295,34
3.000	2.541	1.918	1.477	1.489,72	4.539	3.358	2.537	2.411,59
3.200	2.710	2.046	1.575	1.567,41	4.842	3.582	2.707	2.527,84
3.400	2.880	2.174	1.674	1.645,10	5.144	3.806	2.876	2.644,09
3.600	3.049	2.302	1.772	1.722,80	5.447	4.030	3.045	2.760,33
3.800	3.219	2.430	1.870	1.800,49	5.749	4.254	3.214	2.876,58
4.000	3.388	2.558	1.969	1.878,18	6.052	4.478	3.383	2.992,83
4.200	3.557	2.686	2.067	1.955,87	6.355	4.702	3.552	3.109,08
4.400	3.727	2.813	2.166	2.033,56	6.657	4.926	3.722	3.225,33
4.600	3.896	2.941	2.264	2.111,26	6.960	5.150	3.891	3.341,57
4.800	4.066	3.069	2.363	2.188,95	7.262	5.373	4.060	3.457,82
5.000	4.235	3.197	2.461	2.266,64	7.565	5.597	4.229	3.574,07
5.200	4.404	3.325	2.560	2.344,33	7.868	5.821	4.398	3.690,32
5.400	4.574	3.453	2.658	2.422,02	8.170	6.045	4.567	3.806,57
5.600	4.743	3.581	2.756	2.499,72	8.473	6.269	4.737	3.922,81
5.800	4.913	3.709	2.855	2.577,41	8.775	6.493	4.906	4.039,06
6.000	5.082	3.836	2.953	2.655,10	9.078	6.717	5.075	4.155,31

Precios para color blanco estándar RAL 9016.  
Precios para carta de colores Zehnder +25%. Otros colores, consultar.



# Zehnder Jet X

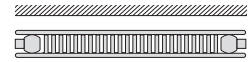
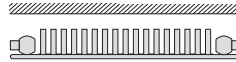
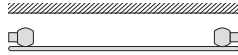
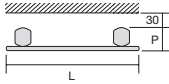
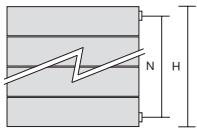

MODELO	NXH49	NXHL49/49	NXHLH49/49
Altura H	514 mm	514 mm	514 mm
Entre ejes N	474 mm	474 mm	474 mm
Profundidad P	45 mm	60 mm	53 mm
Exponente n	1,25	1,30	1,30

Recuerde pedir el Pack de Conexión

Longitud L mm	Emisión EN 442 75/65/20 ΔT 50K W	Emisión Caldera condens. ΔT 40K W	Emisión Bomba de calor ΔT 32,5K W	Blanco RAL 9016 PVP €	Emisión EN 442 75/65/20 ΔT 50K W	Emisión Caldera condens. ΔT 40K W	Emisión Bomba de calor ΔT 32,5K W	Blanco RAL 9016 PVP €	Emisión EN 442 75/65/20 ΔT 50K W	Emisión Caldera condens. ΔT 40K W	Emisión Bomba de calor ΔT 32,5K W	Blanco RAL 9016 PVP €
500	287	217	167	387,15	485	363	277	515,73	553	414	316	833,49
600	344	260	201	409,36	581	435	332	548,77	664	497	379	888,90
700	401	303	234	431,57	678	508	387	581,81	774	579	442	944,31
800	458	347	268	453,78	775	580	443	614,86	885	662	505	999,72
900	516	390	301	475,99	872	653	498	647,90	995	745	569	1.055,13
1.000	573	434	334	498,20	969	725	553	680,94	1.106	828	632	1.110,54
1.100	630	477	368	520,41	1.066	798	609	713,98	1.217	910	695	1.165,95
1.200	688	520	401	542,62	1.163	870	664	747,02	1.327	993	758	1.221,36
1.300	745	564	435	564,83	1.260	943	720	780,07	1.438	1.076	821	1.276,77
1.400	802	607	468	587,04	1.357	1.015	775	813,11	1.548	1.159	884	1.332,18
1.500	860	650	502	609,26	1.454	1.088	830	846,15	1.659	1.241	948	1.387,59
1.600	917	694	535	631,47	1.550	1.160	886	879,19	1.770	1.324	1.011	1.443,00
1.700	974	737	569	653,68	1.647	1.233	941	912,23	1.880	1.407	1.074	1.498,41
1.800	1.031	780	602	675,89	1.744	1.305	996	945,28	1.991	1.490	1.137	1.553,82
1.900	1.089	824	635	698,10	1.841	1.378	1.052	978,32	2.101	1.572	1.200	1.609,23
2.000	1.146	867	669	720,31	1.938	1.450	1.107	1.011,36	2.212	1.655	1.263	1.664,64
2.200	1.261	954	736	764,73	2.132	1.595	1.218	1.077,44	2.433	1.821	1.390	1.775,46
2.400	1.375	1.040	803	809,15	2.326	1.740	1.328	1.143,53	2.654	1.986	1.516	1.886,28
2.600	1.490	1.127	870	853,58	2.519	1.885	1.439	1.209,61	2.876	2.152	1.643	1.997,10
2.800	1.604	1.214	936	898,00	2.713	2.030	1.550	1.275,70	3.097	2.317	1.769	2.107,92
3.000	1.719	1.301	1.003	942,42	2.907	2.175	1.660	1.341,78	3.318	2.483	1.895	2.218,74
3.200	1.834	1.387	1.070	986,84	3.101	2.320	1.771	1.407,86	3.539	2.648	2.022	2.329,56
3.400	1.948	1.474	1.137	1.031,26	3.295	2.465	1.882	1.473,95	3.760	2.814	2.148	2.440,38
3.600	2.063	1.561	1.204	1.075,69	3.488	2.610	1.993	1.540,03	3.982	2.979	2.274	2.551,20
3.800	2.177	1.647	1.271	1.120,11	3.682	2.755	2.103	1.606,12	4.203	3.145	2.401	2.662,02
4.000	2.292	1.734	1.338	1.164,53	3.876	2.900	2.214	1.672,20	4.424	3.310	2.527	2.772,84
4.200	2.407	1.821	1.405	1.208,95	4.070	3.045	2.325	1.738,28	4.645	3.476	2.653	2.883,66
4.400	2.521	1.908	1.471	1.253,37	4.264	3.190	2.435	1.804,37	4.866	3.641	2.780	2.994,48
4.600	2.636	1.994	1.538	1.297,80	4.457	3.335	2.546	1.870,45	5.088	3.807	2.906	3.105,30
4.800	2.750	2.081	1.605	1.342,22	4.651	3.480	2.657	1.936,54	5.309	3.972	3.032	3.216,12
5.000	2.865	2.168	1.672	1.386,64	4.845	3.625	2.767	2.002,62	5.530	4.138	3.159	3.326,94
5.200	2.980	2.254	1.739	1.431,06	5.039	3.770	2.878	2.068,70	5.751	4.303	3.285	3.437,76
5.400	3.094	2.341	1.806	1.475,48	5.233	3.915	2.989	2.134,79	5.972	4.469	3.411	3.548,58
5.600	3.209	2.428	1.873	1.519,91	5.426	4.060	3.100	2.200,87	6.194	4.634	3.538	3.659,40
5.800	3.323	2.514	1.940	1.564,33	5.620	4.205	3.210	2.266,96	6.415	4.800	3.664	3.770,22
6.000	3.438	2.601	2.007	1.608,75	5.814	4.350	3.321	2.333,04	6.636	4.965	3.790	3.881,04

Precios para color blanco estándar RAL 9016.

Precios para carta de colores Zehnder +25%. Otros colores, consultar.



# Zehnder Jet X

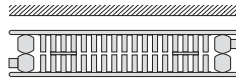
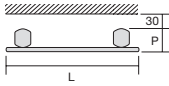
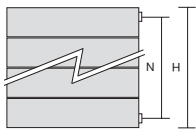

MODELO	NXHH49	NXHLLH49/49
Altura H	514 mm	514 mm
Entre ejes N	474 mm	474 mm
Profundidad P	53 mm	92 mm
Exponente n	1,27	1,36

Recuerde pedir el Pack de Conexión

Longitud L mm	Emisión EN 442 75/65/20 $\Delta T$ 50K W	Emisión Caldera condens. $\Delta T$ 40K W	Emisión Bomba de calor $\Delta T$ 32,5K W	Blanco RAL 9016 PVP €	Emisión EN 442 75/65/20 $\Delta T$ 50K W	Emisión Caldera condens. $\Delta T$ 40K W	Emisión Bomba de calor $\Delta T$ 32,5K W	Blanco RAL 9016 PVP €
500	487	366	282	537,07	848	626	472	1.043,03
600	584	440	338	581,73	1.017	751	566	1.109,08
700	681	513	394	626,39	1.187	876	660	1.175,13
800	778	586	450	671,06	1.356	1.001	755	1.241,18
900	876	660	507	715,72	1.526	1.126	849	1.307,23
1.000	973	733	563	760,38	1.695	1.251	943	1.373,28
1.100	1.070	806	619	805,04	1.865	1.376	1.038	1.439,33
1.200	1.168	879	676	849,70	2.034	1.502	1.132	1.505,38
1.300	1.265	953	732	894,37	2.204	1.627	1.227	1.571,43
1.400	1.362	1.026	788	939,03	2.373	1.752	1.321	1.637,48
1.500	1.460	1.099	845	983,69	2.543	1.877	1.415	1.703,54
1.600	1.557	1.173	901	1.028,35	2.712	2.002	1.510	1.769,59
1.700	1.654	1.246	957	1.073,01	2.882	2.127	1.604	1.835,64
1.800	1.751	1.319	1.013	1.117,68	3.051	2.252	1.698	1.901,69
1.900	1.849	1.392	1.070	1.162,34	3.221	2.378	1.793	1.967,74
2.000	1.946	1.466	1.126	1.207,00	3.390	2.503	1.887	2.033,79
2.200	2.141	1.612	1.239	1.296,32	3.729	2.753	2.076	2.165,89
2.400	2.335	1.759	1.351	1.385,65	4.068	3.003	2.264	2.297,99
2.600	2.530	1.906	1.464	1.474,97	4.407	3.253	2.453	2.430,10
2.800	2.724	2.052	1.576	1.564,30	4.746	3.504	2.642	2.562,20
3.000	2.919	2.199	1.689	1.653,62	5.085	3.754	2.830	2.694,30
3.200	3.114	2.345	1.802	1.742,94	5.424	4.004	3.019	2.826,40
3.400	3.308	2.492	1.914	1.832,27	5.763	4.255	3.208	2.958,50
3.600	3.503	2.638	2.027	1.921,59	6.102	4.505	3.397	3.090,61
3.800	3.697	2.785	2.139	2.010,92	6.441	4.755	3.585	3.222,71
4.000	3.892	2.932	2.252	2.100,24	6.780	5.005	3.774	3.354,81
4.200	4.087	3.078	2.365	2.189,56	7.119	5.256	3.963	3.486,91
4.400	4.281	3.225	2.477	2.278,89	7.458	5.506	4.151	3.619,01
4.600	4.476	3.371	2.590	2.368,21	7.797	5.756	4.340	3.751,12
4.800	4.670	3.518	2.702	2.457,54	8.136	6.006	4.529	3.883,22
5.000	4.865	3.664	2.815	2.546,86	8.475	6.257	4.717	4.015,32
5.200	5.060	3.811	2.928	2.636,18	8.814	6.507	4.906	4.147,42
5.400	5.254	3.958	3.040	2.725,51	9.153	6.757	5.095	4.279,52
5.600	5.449	4.104	3.153	2.814,83	9.492	7.007	5.283	4.411,63
5.800	5.643	4.251	3.265	2.904,16	9.831	7.258	5.472	4.543,73
6.000	5.838	4.397	3.378	2.993,48	10.170	7.508	5.661	4.675,83

Precios para color blanco estándar RAL 9016.  
Precios para carta de colores Zehnder +25%. Otros colores, consultar.



# Zehnder Jet X

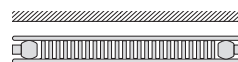
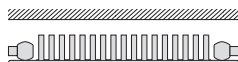
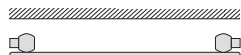
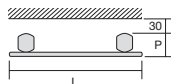
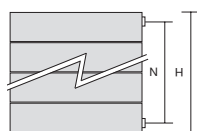

MODELO	NXH56	NXHL56/56	NXHLH56/56
Altura H	588 mm	588 mm	588 mm
Entre ejes N	548 mm	548 mm	548 mm
Profundidad P	45 mm	60 mm	53 mm
Exponente n	1,25	1,31	1,31

Recuerde pedir el Pack de Conexión

Longitud L mm	Emisión EN 442 75/65/20 ΔT 50K W	Emisión Caldera condens. ΔT 40K W	Emisión Bomba de calor ΔT 32,5K W	Blanco RAL 9016 PVP €	Emisión EN 442 75/65/20 ΔT 50K W	Emisión Caldera condens. ΔT 40K W	Emisión Bomba de calor ΔT 32,5K W	Blanco RAL 9016 PVP €	Emisión EN 442 75/65/20 ΔT 50K W	Emisión Caldera condens. ΔT 40K W	Emisión Bomba de calor ΔT 32,5K W	Blanco RAL 9016 PVP €
600	392	296	229	449,03	647	483	368	593,68	740	553	421	977,70
700	457	346	267	474,15	755	564	430	630,69	864	645	491	1.039,60
800	522	395	305	499,28	863	644	491	667,70	987	737	561	1.101,51
900	588	445	343	524,40	971	725	552	704,71	1.111	829	632	1.163,41
1.000	653	494	381	549,52	1.079	806	614	741,72	1.234	921	702	1.225,32
1.100	718	543	419	574,64	1.187	886	675	778,73	1.357	1.013	772	1.287,23
1.200	784	593	457	599,76	1.295	967	736	815,74	1.481	1.105	842	1.349,13
1.300	849	642	495	624,89	1.403	1.047	798	852,75	1.604	1.198	912	1.411,04
1.400	914	692	534	650,01	1.511	1.128	859	889,76	1.728	1.290	983	1.472,94
1.500	980	741	572	675,13	1.619	1.208	921	926,77	1.851	1.382	1.053	1.534,85
1.600	1.045	790	610	700,25	1.726	1.289	982	963,77	1.974	1.474	1.123	1.596,76
1.700	1.110	840	648	725,37	1.834	1.369	1.043	1.000,78	2.098	1.566	1.193	1.658,66
1.800	1.175	889	686	750,50	1.942	1.450	1.105	1.037,79	2.221	1.658	1.263	1.720,57
1.900	1.241	939	724	775,62	2.050	1.530	1.166	1.074,80	2.345	1.750	1.333	1.782,47
2.000	1.306	988	762	800,74	2.158	1.611	1.227	1.111,81	2.468	1.842	1.404	1.844,38
2.200	1.437	1.087	838	850,98	2.374	1.772	1.350	1.185,83	2.715	2.027	1.544	1.968,19
2.400	1.567	1.186	915	901,23	2.590	1.933	1.473	1.259,85	2.962	2.211	1.684	2.092,00
2.600	1.698	1.285	991	951,47	2.805	2.094	1.596	1.333,86	3.208	2.395	1.825	2.215,82
2.800	1.828	1.383	1.067	1.001,72	3.021	2.255	1.718	1.407,88	3.455	2.579	1.965	2.339,63
3.000	1.959	1.482	1.143	1.051,96	3.237	2.417	1.841	1.481,90	3.702	2.764	2.105	2.463,44
3.200	2.090	1.581	1.220	1.102,20	3.453	2.578	1.964	1.555,92	3.949	2.948	2.246	2.587,25
3.400	2.220	1.680	1.296	1.152,45	3.669	2.739	2.086	1.629,94	4.196	3.132	2.386	2.711,06
3.600	2.351	1.779	1.372	1.202,69	3.884	2.900	2.209	1.703,95	4.442	3.316	2.527	2.834,88
3.800	2.481	1.877	1.448	1.252,94	4.100	3.061	2.332	1.777,97	4.689	3.501	2.667	2.958,69
4.000	2.612	1.976	1.524	1.303,18	4.316	3.222	2.455	1.851,99	4.936	3.685	2.807	3.082,50
4.200	2.743	2.075	1.601	1.353,42	4.532	3.383	2.577	1.926,01	5.183	3.869	2.948	3.206,31
4.400	2.873	2.174	1.677	1.403,67	4.748	3.544	2.700	2.000,03	5.430	4.053	3.088	3.330,12
4.600	3.004	2.273	1.753	1.453,91	4.963	3.705	2.823	2.074,04	5.676	4.238	3.228	3.453,94
4.800	3.134	2.371	1.829	1.504,16	5.179	3.866	2.946	2.148,06	5.923	4.422	3.369	3.577,75
5.000	3.265	2.470	1.906	1.554,40	5.395	4.028	3.068	2.222,08	6.170	4.606	3.509	3.701,56
5.200	3.396	2.569	1.982	1.604,64	5.611	4.189	3.191	2.296,10	6.417	4.790	3.650	3.825,37
5.400	3.526	2.668	2.058	1.654,89	5.827	4.350	3.314	2.370,12	6.664	4.975	3.790	3.949,18
5.600	3.657	2.767	2.134	1.705,13	6.042	4.511	3.437	2.444,13	6.910	5.159	3.930	4.073,00
5.800	3.787	2.866	2.210	1.755,38	6.258	4.672	3.559	2.518,15	7.157	5.343	4.071	4.196,81
6.000	3.918	2.964	2.287	1.805,62	6.474	4.833	3.682	2.592,17	7.404	5.527	4.211	4.320,62

Precios para color blanco estándar RAL 9016.

Precios para carta de colores Zehnder +25%. Otros colores, consultar.





# Zehnder Jet X

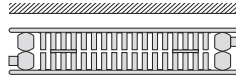
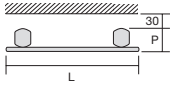
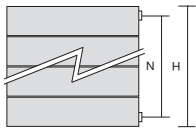

MODELO	NXHH56	NXHLLH56/56
Altura H	588 mm	588 mm
Entre ejes N	548 mm	548 mm
Profundidad P	53 mm	92 mm
Exponente n	1,27	1,38

Recuerde pedir el Pack de Conexión

Longitud L mm	Emisión EN 442 75/65/20 ΔT 50K W	Emisión Caldera condens. ΔT 40K W	Emisión Bomba de calor ΔT 32,5K W	Blanco RAL 9016 PVP €	Emisión EN 442 75/65/20 ΔT 50K W	Emisión Caldera condens. ΔT 40K W	Emisión Bomba de calor ΔT 32,5K W	Blanco RAL 9016 PVP €
600	659	496	381	690,67	1.130	830	623	1.201,57
700	769	579	445	741,14	1.318	969	727	1.275,55
800	878	662	508	791,62	1.506	1.107	831	1.343,52
900	988	744	572	842,09	1.695	1.246	935	1.423,50
1.000	1.098	827	635	892,57	1.883	1.384	1.039	1.497,48
1.100	1.208	910	699	943,05	2.071	1.522	1.143	1.571,46
1.200	1.318	992	762	993,52	2.260	1.661	1.247	1.645,44
1.300	1.427	1.075	826	1.044,00	2.448	1.799	1.351	1.719,41
1.400	1.537	1.158	889	1.094,47	2.636	1.938	1.455	1.793,39
1.500	1.647	1.241	953	1.144,95	2.825	2.076	1.559	1.867,37
1.600	1.757	1.323	1.017	1.195,43	3.013	2.214	1.663	1.941,35
1.700	1.867	1.406	1.080	1.245,90	3.201	2.353	1.767	2.015,33
1.800	1.976	1.489	1.144	1.296,38	3.389	2.491	1.870	2.089,30
1.900	2.086	1.571	1.207	1.346,85	3.578	2.629	1.974	2.163,28
2.000	2.196	1.654	1.271	1.397,33	3.766	2.768	2.078	2.237,26
2.200	2.416	1.819	1.398	1.498,28	4.143	3.045	2.286	2.385,22
2.400	2.635	1.985	1.525	1.599,23	4.519	3.321	2.494	2.533,17
2.600	2.855	2.150	1.652	1.700,19	4.896	3.598	2.702	2.681,13
2.800	3.074	2.316	1.779	1.801,14	5.272	3.875	2.910	2.829,08
3.000	3.294	2.481	1.906	1.902,09	5.649	4.152	3.117	2.977,04
3.200	3.514	2.647	2.033	2.003,04	6.026	4.429	3.325	3.125,00
3.400	3.733	2.812	2.160	2.103,99	6.402	4.705	3.533	3.272,95
3.600	3.953	2.977	2.287	2.204,95	6.779	4.982	3.741	3.420,91
3.800	4.172	3.143	2.414	2.305,90	7.155	5.259	3.949	3.568,86
4.000	4.392	3.308	2.541	2.406,85	7.532	5.536	4.157	3.716,82
4.200	4.612	3.474	2.668	2.507,80	7.909	5.813	4.364	3.864,78
4.400	4.831	3.639	2.795	2.608,75	8.285	6.089	4.572	4.012,73
4.600	5.051	3.804	2.923	2.709,71	8.662	6.366	4.780	4.160,69
4.800	5.270	3.970	3.050	2.810,66	9.038	6.643	4.988	4.308,64
5.000	5.490	4.135	3.177	2.911,61	9.415	6.920	5.196	4.456,60
5.200	5.710	4.301	3.304	3.012,56	9.792	7.196	5.403	4.604,56
5.400	5.929	4.466	3.431	3.113,51	10.168	7.473	5.611	4.752,51
5.600	6.149	4.631	3.558	3.214,47	10.545	7.750	5.819	4.900,47
5.800	6.368	4.797	3.685	3.315,42	10.921	8.027	6.027	5.048,42
6.000	6.588	4.962	3.812	3.416,37	11.298	8.304	6.235	5.196,38

Precios para color blanco estándar RAL 9016.  
Precios para carta de colores Zehnder +25%. Otros colores, consultar.



# Zehnder Jet X

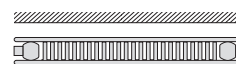
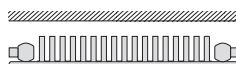
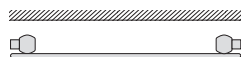
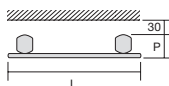
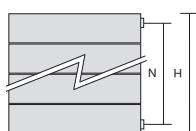

MODELO	NXH63	NXHL63/56	NXHLH63/56
Altura H	662 mm	662 mm	662 mm
Entre ejes N	622 mm	622 mm	622 mm
Profundidad P	45 mm	60 mm	53 mm
Exponente n	1,25	1,31	1,31

Recuerde pedir el Pack de Conexión

Longitud L mm	Emisión EN 442 75/65/20 ΔT 50K W	Emisión Caldera condens. ΔT 40K W	Emisión Bomba de calor ΔT 32,5K W	Blanco RAL 9016 PVP €	Emisión EN 442 75/65/20 ΔT 50K W	Emisión Caldera condens. ΔT 40K W	Emisión Bomba de calor ΔT 32,5K W	Blanco RAL 9016 PVP €	Emisión EN 442 75/65/20 ΔT 50K W	Emisión Caldera condens. ΔT 40K W	Emisión Bomba de calor ΔT 32,5K W	Blanco RAL 9016 PVP €
700	514	389	300	516,72	799	596	454	672,18	921	687	524	1.127,96
800	587	444	343	544,76	913	681	519	712,10	1.052	785	598	1.195,35
900	661	500	386	572,79	1.027	767	584	752,02	1.184	884	673	1.262,75
1.000	734	555	428	600,82	1.141	852	649	791,94	1.315	982	748	1.330,15
1.100	807	611	471	628,85	1.255	937	714	831,86	1.447	1.080	823	1.397,55
1.200	881	666	514	656,88	1.369	1.022	779	871,78	1.578	1.178	897	1.464,95
1.300	954	722	557	684,92	1.483	1.107	844	911,70	1.710	1.276	972	1.532,34
1.400	1.028	777	600	712,95	1.597	1.193	909	951,62	1.841	1.374	1.047	1.599,74
1.500	1.101	833	643	740,98	1.712	1.278	973	991,54	1.973	1.473	1.122	1.667,14
1.600	1.174	889	685	769,01	1.826	1.363	1.038	1.031,45	2.104	1.571	1.197	1.734,54
1.700	1.248	944	728	797,04	1.940	1.448	1.103	1.071,37	2.236	1.669	1.271	1.801,94
1.800	1.321	1.000	771	825,08	2.054	1.533	1.168	1.111,29	2.367	1.767	1.346	1.869,33
1.900	1.395	1.055	814	853,11	2.168	1.618	1.233	1.151,21	2.499	1.865	1.421	1.936,73
2.000	1.468	1.111	857	881,14	2.282	1.704	1.298	1.191,13	2.630	1.963	1.496	2.004,13
2.200	1.615	1.222	942	937,20	2.510	1.874	1.428	1.270,97	2.893	2.160	1.645	2.138,93
2.400	1.762	1.333	1.028	993,27	2.738	2.044	1.557	1.350,81	3.156	2.356	1.795	2.273,72
2.600	1.908	1.444	1.114	1.049,33	2.967	2.215	1.687	1.430,64	3.419	2.552	1.945	2.408,52
2.800	2.055	1.555	1.199	1.105,40	3.195	2.385	1.817	1.510,48	3.682	2.749	2.094	2.543,31
3.000	2.202	1.666	1.285	1.161,46	3.423	2.555	1.947	1.590,32	3.945	2.945	2.244	2.678,11
3.200	2.349	1.777	1.371	1.217,52	3.651	2.726	2.077	1.670,16	4.208	3.141	2.393	2.812,91
3.400	2.496	1.888	1.457	1.273,59	3.879	2.896	2.206	1.750,00	4.471	3.338	2.543	2.947,70
3.600	2.642	1.999	1.542	1.329,65	4.108	3.066	2.336	1.829,83	4.734	3.534	2.692	3.082,50
3.800	2.789	2.110	1.628	1.385,72	4.336	3.237	2.466	1.909,67	4.997	3.730	2.842	3.217,29
4.000	2.936	2.221	1.714	1.441,78	4.564	3.407	2.596	1.989,51	5.260	3.927	2.992	3.352,09
4.200	3.083	2.332	1.799	1.497,84	4.792	3.578	2.726	2.069,35	5.523	4.123	3.141	3.486,89
4.400	3.230	2.443	1.885	1.553,91	5.020	3.748	2.855	2.149,19	5.786	4.319	3.291	3.621,68
4.600	3.376	2.555	1.971	1.609,97	5.249	3.918	2.985	2.229,02	6.049	4.516	3.440	3.756,48
4.800	3.523	2.666	2.056	1.666,04	5.477	4.089	3.115	2.308,86	6.312	4.712	3.590	3.891,27
5.000	3.670	2.777	2.142	1.722,10	5.705	4.259	3.245	2.388,70	6.575	4.908	3.739	4.026,07
5.200	3.817	2.888	2.228	1.778,16	5.933	4.429	3.374	2.468,54	6.838	5.105	3.889	4.160,87
5.400	3.964	2.999	2.313	1.834,23	6.161	4.600	3.504	2.548,38	7.101	5.301	4.039	4.295,66
5.600	4.110	3.110	2.399	1.890,29	6.390	4.770	3.634	2.628,21	7.364	5.497	4.188	4.430,46
5.800	4.257	3.221	2.485	1.946,36	6.618	4.940	3.764	2.708,05	7.627	5.694	4.338	4.565,25
6.000	4.404	3.332	2.570	2.002,42	6.846	5.111	3.894	2.787,89	7.890	5.890	4.487	4.700,05

Precios para color blanco estándar RAL 9016.  
Precios para carta de colores Zehnder +25%. Otros colores, consultar.



# Zehnder Jet X

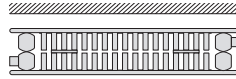
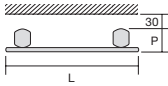
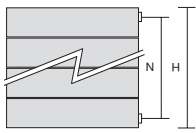

MODELO	NXHH63	NXHLLH63/56
Altura H	662 mm	662 mm
Entre ejes N	622 mm	622 mm
Profundidad P	53 mm	92 mm
Exponente n	1,28	1,37

Recuerde pedir el Pack de Conexión

Longitud L mm	Emisión EN 442 75/65/20 ΔT 50K W	Emisión Caldera condens. ΔT 40K W	Emisión Bomba de calor ΔT 32,5K W	Blanco RAL 9016 PVP €	Emisión EN 442 75/65/20 ΔT 50K W	Emisión Caldera condens. ΔT 40K W	Emisión Bomba de calor ΔT 32,5K W	Blanco RAL 9016 PVP €
700	856	643	493	813,56	1.378	1.015	764	1.361,18
800	978	735	564	869,85	1.574	1.160	873	1.440,98
900	1.101	827	634	926,13	1.771	1.305	982	1.520,77
1.000	1.223	919	705	982,42	1.968	1.450	1.091	1.600,56
1.100	1.345	1.011	775	1.038,71	2.165	1.595	1.200	1.680,35
1.200	1.468	1.103	846	1.094,99	2.362	1.740	1.309	1.760,14
1.300	1.590	1.195	916	1.151,28	2.558	1.885	1.418	1.839,94
1.400	1.712	1.287	986	1.207,56	2.755	2.029	1.527	1.919,73
1.500	1.835	1.379	1.057	1.263,85	2.952	2.174	1.636	1.999,52
1.600	1.957	1.471	1.127	1.320,14	3.149	2.319	1.745	2.079,31
1.700	2.079	1.563	1.198	1.376,42	3.346	2.464	1.854	2.159,10
1.800	2.201	1.654	1.268	1.432,71	3.542	2.609	1.963	2.238,90
1.900	2.324	1.746	1.339	1.488,99	3.739	2.754	2.072	2.318,69
2.000	2.446	1.838	1.409	1.545,28	3.936	2.899	2.181	2.398,48
2.200	2.691	2.022	1.550	1.657,85	4.330	3.189	2.400	2.558,06
2.400	2.935	2.206	1.691	1.770,42	4.723	3.479	2.618	2.717,65
2.600	3.180	2.390	1.832	1.883,00	5.117	3.769	2.836	2.877,23
2.800	3.424	2.574	1.973	1.995,57	5.510	4.059	3.054	3.036,82
3.000	3.669	2.757	2.114	2.108,14	5.904	4.349	3.272	3.196,40
3.200	3.914	2.941	2.255	2.220,71	6.298	4.639	3.490	3.355,98
3.400	4.158	3.125	2.396	2.333,28	6.691	4.929	3.708	3.515,57
3.600	4.403	3.309	2.537	2.445,86	7.085	5.219	3.927	3.675,15
3.800	4.647	3.493	2.678	2.558,43	7.478	5.509	4.145	3.834,74
4.000	4.892	3.677	2.818	2.671,00	7.872	5.799	4.363	3.994,32
4.200	5.137	3.860	2.959	2.783,57	8.266	6.088	4.581	4.153,90
4.400	5.381	4.044	3.100	2.896,14	8.659	6.378	4.799	4.313,49
4.600	5.626	4.228	3.241	3.008,72	9.053	6.668	5.017	4.473,07
4.800	5.870	4.412	3.382	3.121,29	9.446	6.958	5.235	4.632,66
5.000	6.115	4.596	3.523	3.233,86	9.840	7.248	5.454	4.792,24
5.200	6.360	4.780	3.664	3.346,43	10.234	7.538	5.672	4.951,82
5.400	6.604	4.963	3.805	3.459,00	10.627	7.828	5.890	5.111,41
5.600	6.849	5.147	3.946	3.571,58	11.021	8.118	6.108	5.270,99
5.800	7.093	5.331	4.087	3.684,15	11.414	8.408	6.326	5.430,58
6.000	7.338	5.515	4.228	3.796,72	11.808	8.698	6.544	5.590,16

Precios para color blanco estándar RAL 9016.  
Precios para carta de colores Zehnder +25%. Otros colores, consultar.



# Zehnder Jet X

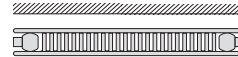
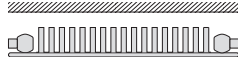
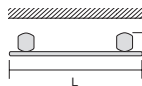
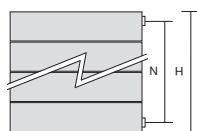

MODELO	NXH70	NXHL70/56	NXHLH70/56
Altura H	736 mm	736 mm	736 mm
Entre ejes N	696 mm	696 mm	696 mm
Profundidad P	45 mm	45 mm	53 mm
Exponente n	1,25	1,31	1,31

Recuerde pedir el Pack de Conexión

Longitud L mm	Emisión EN 442 75/65/20 ΔT 50K W	Emisión Caldera condens. ΔT 40K W	Emisión Bomba de calor ΔT 32,5K W	Blanco RAL 9016 PVP €	Emisión EN 442 75/65/20 ΔT 50K W	Emisión Caldera condens. ΔT 40K W	Emisión Bomba de calor ΔT 32,5K W	Blanco RAL 9016 PVP €	Emisión EN 442 75/65/20 ΔT 50K W	Emisión Caldera condens. ΔT 40K W	Emisión Bomba de calor ΔT 32,5K W	Blanco RAL 9016 PVP €
800	654	495	382	590,22	962	718	547	756,48	1.117	834	635	1.289,31
900	736	557	430	621,16	1.083	808	616	799,31	1.256	938	715	1.362,20
1.000	818	619	477	652,10	1.203	898	684	842,13	1.396	1.042	794	1.435,09
1.100	900	681	525	683,04	1.323	988	753	884,96	1.536	1.146	873	1.507,98
1.200	982	743	573	713,98	1.444	1.078	821	927,78	1.675	1.251	953	1.580,87
1.300	1.063	805	621	744,92	1.564	1.167	889	970,61	1.815	1.355	1.032	1.653,76
1.400	1.145	866	668	775,86	1.684	1.257	958	1.013,43	1.954	1.459	1.112	1.726,65
1.500	1.227	928	716	806,80	1.805	1.347	1.026	1.056,26	2.094	1.563	1.191	1.799,54
1.600	1.309	990	764	837,73	1.925	1.437	1.095	1.099,08	2.234	1.667	1.270	1.872,42
1.700	1.391	1.052	812	868,67	2.045	1.527	1.163	1.141,91	2.373	1.772	1.350	1.945,31
1.800	1.472	1.114	859	899,61	2.165	1.617	1.232	1.184,73	2.513	1.876	1.429	2.018,20
1.900	1.554	1.176	907	930,55	2.286	1.706	1.300	1.227,56	2.652	1.980	1.509	2.091,09
2.000	1.636	1.238	955	961,49	2.406	1.796	1.368	1.270,38	2.792	2.084	1.588	2.163,98
2.200	1.800	1.362	1.050	1.023,37	2.647	1.976	1.505	1.356,03	3.071	2.293	1.747	2.309,76
2.400	1.963	1.485	1.146	1.085,25	2.887	2.155	1.642	1.441,68	3.350	2.501	1.906	2.455,54
2.600	2.127	1.609	1.241	1.147,12	3.128	2.335	1.779	1.527,33	3.630	2.710	2.064	2.601,31
2.800	2.290	1.733	1.337	1.209,00	3.368	2.515	1.916	1.612,98	3.909	2.918	2.223	2.747,09
3.000	2.454	1.857	1.432	1.270,88	3.609	2.694	2.053	1.698,63	4.188	3.126	2.382	2.892,87
3.200	2.618	1.980	1.528	1.332,76	3.850	2.874	2.189	1.784,28	4.467	3.335	2.541	3.038,65
3.400	2.781	2.104	1.623	1.394,64	4.090	3.053	2.326	1.869,93	4.746	3.543	2.699	3.184,43
3.600	2.945	2.228	1.719	1.456,51	4.331	3.233	2.463	1.955,58	5.026	3.752	2.858	3.330,20
3.800	3.108	2.352	1.814	1.518,39	4.571	3.413	2.600	2.041,23	5.305	3.960	3.017	3.475,98
4.000	3.272	2.476	1.910	1.580,27	4.812	3.592	2.737	2.126,88	5.584	4.169	3.176	3.621,76
4.200	3.436	2.599	2.005	1.642,15	5.053	3.772	2.874	2.212,53	5.863	4.377	3.335	3.767,54
4.400	3.599	2.723	2.101	1.704,03	5.293	3.952	3.010	2.298,18	6.142	4.585	3.493	3.913,32
4.600	3.763	2.847	2.196	1.765,90	5.534	4.131	3.147	2.383,83	6.422	4.794	3.652	4.059,09
4.800	3.926	2.971	2.292	1.827,78	5.774	4.311	3.284	2.469,48	6.701	5.002	3.811	4.204,87
5.000	4.090	3.094	2.387	1.889,66	6.015	4.490	3.421	2.555,13	6.980	5.211	3.970	4.350,65
5.200	4.254	3.218	2.483	1.951,54	6.256	4.670	3.558	2.640,78	7.259	5.419	4.129	4.496,43
5.400	4.417	3.342	2.578	2.013,42	6.496	4.850	3.695	2.726,43	7.538	5.628	4.287	4.642,21
5.600	4.581	3.466	2.674	2.075,29	6.737	5.029	3.832	2.812,08	7.818	5.836	4.446	4.787,98
5.800	4.744	3.590	2.769	2.137,17	6.977	5.209	3.968	2.897,73	8.097	6.045	4.605	4.933,76
6.000	4.908	3.713	2.864	2.199,05	7.218	5.388	4.105	2.983,38	8.376	6.253	4.764	5.079,54

Precios para color blanco estándar RAL 9016.

Precios para carta de colores Zehnder +25%. Otros colores, consultar.



# Zehnder Jet X

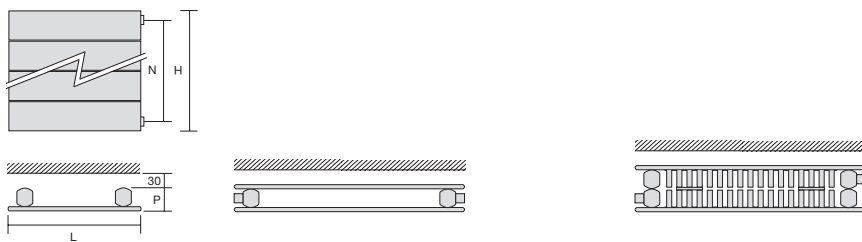

MODELO	NXHH70	NXHLLH70/56
Altura H	736 mm	736 mm
Entre ejes N	696 mm	696 mm
Profundidad P	53 mm	92 mm
Exponente n	1,28	1,37

Recuerde pedir el Pack de Conexión

Longitud L mm	Emisión EN 442 75/65/20 ΔT 50K W	Emisión Caldera condens. ΔT 40K W	Emisión Bomba de calor ΔT 32,5K W	Blanco RAL 9016 PVP €	Emisión EN 442 75/65/20 ΔT 50K W	Emisión Caldera condens. ΔT 40K W	Emisión Bomba de calor ΔT 32,5K W	Blanco RAL 9016 PVP €
800	1.079	811	622	948,08	1.642	1.210	910	1.532,41
900	1.214	912	699	1.010,19	1.848	1.361	1.024	1.618,01
1.000	1.349	1.014	777	1.072,29	2.053	1.512	1.138	1.703,62
1.100	1.484	1.115	855	1.134,39	2.258	1.663	1.252	1.789,23
1.200	1.619	1.217	933	1.196,50	2.464	1.815	1.365	1.874,83
1.300	1.754	1.318	1.010	1.258,60	2.669	1.966	1.479	1.960,44
1.400	1.889	1.419	1.088	1.320,70	2.874	2.117	1.593	2.046,04
1.500	2.024	1.521	1.166	1.382,81	3.080	2.268	1.707	2.131,65
1.600	2.158	1.622	1.244	1.444,91	3.285	2.420	1.821	2.217,26
1.700	2.293	1.724	1.321	1.507,01	3.490	2.571	1.934	2.302,86
1.800	2.428	1.825	1.399	1.569,11	3.695	2.722	2.048	2.388,47
1.900	2.563	1.926	1.477	1.631,22	3.901	2.873	2.162	2.474,07
2.000	2.698	2.028	1.554	1.693,32	4.106	3.024	2.276	2.559,68
2.200	2.968	2.230	1.710	1.817,53	4.517	3.327	2.503	2.730,89
2.400	3.238	2.433	1.865	1.941,73	4.927	3.629	2.731	2.902,10
2.600	3.507	2.636	2.021	2.065,94	5.338	3.932	2.958	3.073,32
2.800	3.777	2.839	2.176	2.190,14	5.748	4.234	3.186	3.244,53
3.000	4.047	3.042	2.332	2.314,35	6.159	4.537	3.414	3.415,74
3.200	4.317	3.244	2.487	2.438,56	6.570	4.839	3.641	3.586,95
3.400	4.587	3.447	2.643	2.562,76	6.980	5.142	3.869	3.758,16
3.600	4.856	3.650	2.798	2.686,97	7.391	5.444	4.096	3.929,38
3.800	5.126	3.853	2.953	2.811,17	7.801	5.747	4.324	4.100,59
4.000	5.396	4.055	3.109	2.935,38	8.212	6.049	4.551	4.271,80
4.200	5.666	4.258	3.264	3.059,59	8.623	6.351	4.779	4.443,01
4.400	5.936	4.461	3.420	3.183,79	9.033	6.654	5.006	4.614,22
4.600	6.205	4.664	3.575	3.308,00	9.444	6.956	5.234	4.785,44
4.800	6.475	4.866	3.731	3.432,20	9.854	7.259	5.462	4.956,65
5.000	6.745	5.069	3.886	3.556,41	10.265	7.561	5.689	5.127,86
5.200	7.015	5.272	4.042	3.680,62	10.676	7.864	5.917	5.299,07
5.400	7.285	5.475	4.197	3.804,82	11.086	8.166	6.144	5.470,28
5.600	7.554	5.677	4.352	3.929,03	11.497	8.469	6.372	5.641,50
5.800	7.824	5.880	4.508	4.053,23	11.907	8.771	6.599	5.812,71
6.000	8.094	6.083	4.663	4.177,44	12.318	9.073	6.827	5.983,92

Precios para color blanco estándar RAL 9016.  
Precios para carta de colores Zehnder +25%. Otros colores, consultar.



# Zehnder Jet X

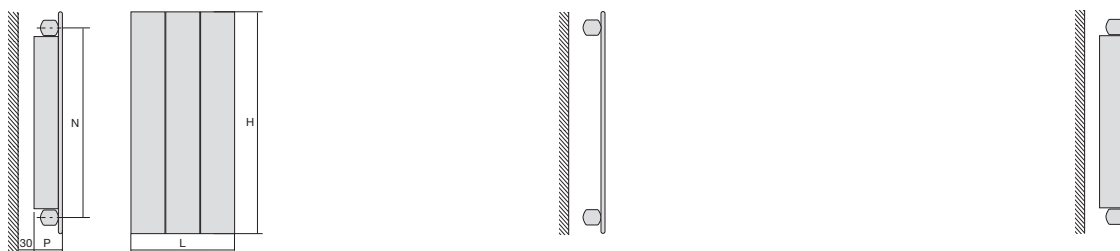

MODELO	NXV60	NXVL60
Altura H	600 mm	600 mm
Entre ejes N	532 mm	532 mm
Profundidad P	45 mm	58 mm
Exponente n	1,28	1,28

Recuerde pedir el Pack de Conexión

Elementos	Longitud L		Emisión EN 442 75/65/20 $\Delta T$ 50K W	Emisión Caldera condens. $\Delta T$ 40K W	Emisión Bomba de calor $\Delta T$ 32,5K W	Blanco RAL 9016 PVP €	Emisión EN 442 75/65/20 $\Delta T$ 50K W	Emisión Caldera condens. $\Delta T$ 40K W	Emisión Bomba de calor $\Delta T$ 32,5K W	Blanco RAL 9016 PVP €
	Nominal mm	Real mm								
2	140	144	96	72	55	211,11	144	108	83	374,98
3	210	218	144	108	83	250,77	216	162	124	413,56
4	280	292	192	144	111	290,43	288	216	166	452,14
5	350	366	240	180	138	330,09	360	271	207	490,72
6	420	440	288	216	166	369,75	432	325	249	529,30
7	490	514	336	253	194	409,41	504	379	290	567,88
8	560	588	384	289	221	449,07	576	433	332	606,46

Precios para color blanco estándar RAL 9016.  
Precios para carta de colores Zehnder +25%. Otros colores, consultar.



# Zehnder Jet X

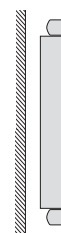
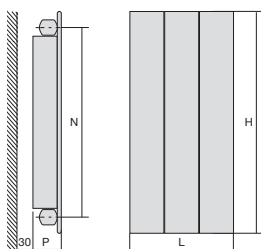

MODELO	NXV80	NXVL80
Altura H	800 mm	800 mm
Entre ejes N	732 mm	732 mm
Profundidad P	45 mm	58 mm
Exponente n	1,29	1,30

Recuerde pedir el Pack de Conexión

Elementos	Longitud L		Emisión EN 442 75/65/20 ΔT 50K W	Emisión Caldera condens. ΔT 40K W	Emisión Bomba de calor ΔT 32,5K W	Blanco RAL 9016 PVP €	Emisión EN 442 75/65/20 ΔT 50K W	Emisión Caldera condens. ΔT 40K W	Emisión Bomba de calor ΔT 32,5K W	Blanco RAL 9016 PVP €
	Nominal mm	Real mm								
2	140	144	126	94	72	226,42	182	136	104	418,33
3	210	218	189	142	108	271,89	273	204	156	462,73
4	280	292	252	189	145	317,36	364	272	208	507,13
5	350	366	315	236	181	362,83	455	340	260	551,53
6	420	440	378	283	217	408,30	546	409	312	595,93
7	490	514	441	331	253	453,77	637	477	364	640,33
8	560	588	504	378	289	499,24	728	545	416	684,73
9	630	662	567	425	325	544,71	819	613	468	729,13
10	700	736	630	472	361	590,18	910	681	520	773,53
11	770	810	693	520	398	635,65	1.001	749	572	817,93

Zehnder Jet X

Precios para color blanco estándar RAL 9016.

Precios para carta de colores Zehnder +25%. Otros colores, consultar.



# Zehnder Jet X

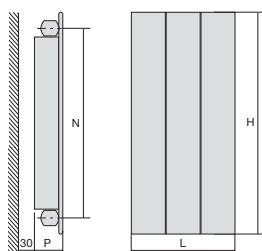

MODELO	NXV100	NXVL100
Altura H	1.000 mm	1.000 mm
Entre ejes N	932 mm	932 mm
Profundidad P	45 mm	58 mm
Exponente n	1,30	1,31

Recuerde pedir el Pack de Conexión

Elementos	Longitud L		Emisión EN 442 75/65/20 ΔT 50K W	Emisión Caldera condens. ΔT 40K W	Emisión Bomba de calor ΔT 32,5K W	Blanco RAL 9016 PVP €	Emisión EN 442 75/65/20 ΔT 50K W	Emisión Caldera condens. ΔT 40K W	Emisión Bomba de calor ΔT 32,5K W	Blanco RAL 9016 PVP €
	Nominal mm	Real mm								
2	140	144	156	117	89	241,77	220	164	125	461,67
3	210	218	234	175	134	293,07	330	246	188	511,90
4	280	292	312	233	178	344,37	440	328	250	562,13
5	350	366	390	292	223	395,67	550	411	313	612,36
6	420	440	468	350	267	446,97	660	493	375	662,59
7	490	514	546	409	312	498,27	770	575	438	712,82
8	560	588	624	467	356	549,57	880	657	500	763,05
9	630	662	702	525	401	600,87	990	739	563	813,28
10	700	736	780	584	446	652,17	1.100	821	626	863,51
11	770	810	858	642	490	703,47	1.210	903	688	913,74
12	840	884	936	700	535	754,77	1.320	985	751	963,97
13	910	958	1.014	759	579	806,07	1.430	1.068	813	1.014,20
14	980	1.032	1.092	817	624	857,37	1.540	1.150	876	1.064,43

Precios para color blanco estándar RAL 9016.

Precios para carta de colores Zehnder +25%. Otros colores, consultar.





# Zehnder Jet X

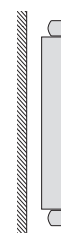
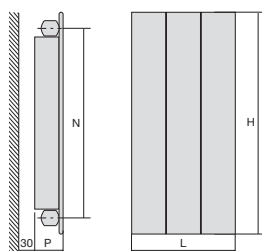

MODELO	NXV120	NXVL120
Altura H	1.200 mm	1.200 mm
Entre ejes N	1.132 mm	1.132 mm
Profundidad P	45 mm	58 mm
Exponente n	1,31	1,32

Recuerde pedir el Pack de Conexión

Elementos	Longitud L		Emisión EN 442 75/65/20 ΔT 50K W	Emisión Caldera condens. ΔT 40K W	Emisión Bomba de calor ΔT 32,5K W	Blanco RAL 9016 PVP €	Emisión EN 442 75/65/20 ΔT 50K W	Emisión Caldera condens. ΔT 40K W	Emisión Bomba de calor ΔT 32,5K W	Blanco RAL 9016 PVP €
	Nominal mm	Real mm								
2	140	144	186	139	106	257,14	260	194	147	505,00
3	210	218	279	208	159	314,24	390	290	221	561,04
4	280	292	372	278	212	371,34	520	387	294	617,08
5	350	366	465	347	264	428,44	650	484	368	673,12
6	420	440	558	417	317	485,54	780	581	442	729,16
7	490	514	651	486	370	542,64	910	678	515	785,20
8	560	588	744	555	423	599,74	1.040	775	589	841,24
9	630	662	837	625	476	656,84	1.170	871	663	897,28
10	700	736	930	694	529	713,94	1.300	968	736	953,32
11	770	810	1.023	764	582	771,04	1.430	1.065	810	1.009,36
12	840	884	1.116	833	635	828,14	1.560	1.162	883	1.065,40
13	910	958	1.209	903	688	885,24	1.690	1.259	957	1.121,44
14	980	1.032	1.302	972	741	942,34	1.820	1.356	1.031	1.177,48
15	1.050	1.106	1.395	1.041	793	999,44	1.950	1.452	1.104	1.233,52
16	1.120	1.180	1.488	1.111	846	1.056,54				
17	1.190	1.254	1.581	1.180	899	1.113,64				

Zehnder Jet X

Precios para color blanco estándar RAL 9016.  
Precios para carta de colores Zehnder +25%. Otros colores, consultar.



# Zehnder Jet X

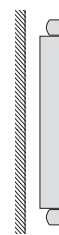
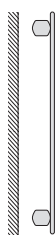
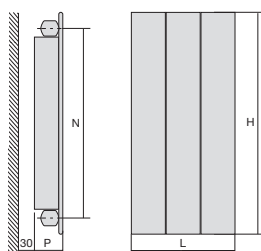

MODELO	NXV140	NXVL140
Altura H	1.400 mm	1.400 mm
Entre ejes N	1.332 mm	1.332 mm
Profundidad P	45 mm	58 mm
Exponente n	1,31	1,31

Recuerde pedir el Pack de Conexión

Elementos	Longitud L		Emisión EN 442 75/65/20 ΔT 50K W	Emisión Caldera condens. ΔT 40K W	Emisión Bomba de calor ΔT 32,5K W	Blanco RAL 9016 PVP €	Emisión EN 442 75/65/20 ΔT 50K W	Emisión Caldera condens. ΔT 40K W	Emisión Bomba de calor ΔT 32,5K W	Blanco RAL 9016 PVP €
	Nominal mm	Real mm								
2	140	144	216	161	123	272,46	298	222	169	548,33
3	210	218	324	242	184	335,38	447	334	254	610,18
4	280	292	432	323	246	398,30	596	445	339	672,03
5	350	366	540	403	307	461,22	745	556	424	733,88
6	420	440	648	484	369	524,14	894	667	508	795,73
7	490	514	756	564	430	587,06	1.043	779	593	857,58
8	560	588	864	645	491	649,98	1.192	890	678	919,43
9	630	662	972	726	553	712,90	1.341	1.001	763	981,28
10	700	736	1.080	806	614	775,82	1.490	1.112	847	1.043,13
11	770	810	1.188	887	676	838,74	1.639	1.224	932	1.104,98
12	840	884	1.296	968	737	901,66	1.788	1.335	1.017	1.166,83
13	910	958	1.404	1.048	799	964,58	1.937	1.446	1.102	1.228,68
14	980	1.032	1.512	1.129	860	1.027,50	2.086	1.557	1.186	1.290,53
15	1.050	1.106	1.620	1.209	921	1.090,42	2.235	1.668	1.271	1.352,38
16	1.120	1.180	1.728	1.290	983	1.153,34				
17	1.190	1.254	1.836	1.371	1.044	1.216,26				
18	1.260	1.328	1.944	1.451	1.106	1.279,18				
19	1.330	1.402	2.052	1.532	1.167	1.342,10				
20	1.400	1.476	2.160	1.613	1.228	1.405,02				

Precios para color blanco estándar RAL 9016.

Precios para carta de colores Zehnder +25%. Otros colores, consultar.



# Zehnder Jet X

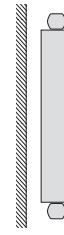
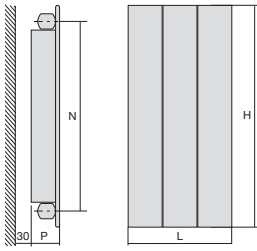

MODELO	NXV160	NXVL160
Altura H	1.600 mm	1.600 mm
Entre ejes N	1.532 mm	1.532 mm
Profundidad P	45 mm	58 mm
Exponente n	1,31	1,31

Recuerde pedir el Pack de Conexión

Elementos	Longitud L		Emisión EN 442 75/65/20 ΔT 50K W	Emisión Caldera condens. ΔT 40K W	Emisión Bomba de calor ΔT 32,5K W	Blanco RAL 9016 PVP €	Emisión EN 442 75/65/20 ΔT 50K W	Emisión Caldera condens. ΔT 40K W	Emisión Bomba de calor ΔT 32,5K W	Blanco RAL 9016 PVP €
	Nominal mm	Real mm								
2	140	144	246	184	140	287,77	340	254	193	591,67
3	210	218	369	275	210	356,53	510	381	290	659,35
4	280	292	492	367	280	425,29	680	508	387	727,03
5	350	366	615	459	350	494,05	850	635	483	794,71
6	420	440	738	551	420	562,81	1.020	761	580	862,39
7	490	514	861	643	490	631,57	1.190	888	677	930,07
8	560	588	984	735	560	700,33	1.360	1.015	773	997,75
9	630	662	1.107	826	630	769,09	1.530	1.142	870	1.065,43
10	700	736	1.230	918	700	837,85	1.700	1.269	967	1.133,11
11	770	810	1.353	1.010	770	906,61	1.870	1.396	1.064	1.200,79
12	840	884	1.476	1.102	839	975,37	2.040	1.523	1.160	1.268,47
13	910	958	1.599	1.194	909	1.044,13	2.210	1.650	1.257	1.336,15
14	980	1.032	1.722	1.286	979	1.112,89	2.380	1.777	1.354	1.403,83
15	1.050	1.106	1.845	1.377	1.049	1.181,65	2.550	1.904	1.450	1.471,51
16	1.120	1.180	1.968	1.469	1.119	1.250,41				
17	1.190	1.254	2.091	1.561	1.189	1.319,17				
18	1.260	1.328	2.214	1.653	1.259	1.387,93				
19	1.330	1.402	2.337	1.745	1.329	1.456,69				
20	1.400	1.476	2.460	1.836	1.399	1.525,45				
21	1.470	1.550	2.583	1.928	1.469	1.594,21				
22	1.540	1.624	2.706	2.020	1.539	1.662,97				

Zehnder Jet X

Precios para color blanco estándar RAL 9016.  
Precios para carta de colores Zehnder +25%. Otros colores, consultar.



# Zehnder Jet X

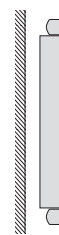
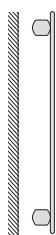
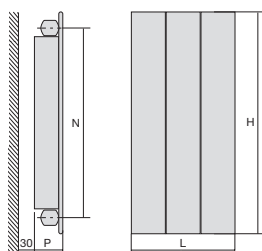

MODELO	NXV180	NXVL180
Altura H	1.800 mm	1.800 mm
Entre ejes N	1.732 mm	1.732 mm
Profundidad P	45 mm	58 mm
Exponente n	1,30	1,31

Recuerde pedir el Pack de Conexión

Elementos	Longitud L		Emisión EN 442 75/65/20 ΔT 50K W	Emisión Caldera condens. ΔT 40K W	Emisión Bomba de calor ΔT 32,5K W	Blanco RAL 9016 PVP €	Emisión EN 442 75/65/20 ΔT 50K W	Emisión Caldera condens. ΔT 40K W	Emisión Bomba de calor ΔT 32,5K W	Blanco RAL 9016 PVP €
	Nominal mm	Real mm								
2	140	144	286	214	163	303,09	382	285	217	635,02
3	210	218	429	321	245	377,64	573	428	326	708,52
4	280	292	572	428	327	452,19	764	570	435	782,02
5	350	366	715	535	408	526,74	955	713	543	855,52
6	420	440	858	642	490	601,29	1.146	856	652	929,02
7	490	514	1.001	749	572	675,84	1.337	998	760	1.002,52
8	560	588	1.144	856	653	750,39	1.528	1.141	869	1.076,02
9	630	662	1.287	963	735	824,94	1.719	1.283	978	1.149,52
10	700	736	1.430	1.070	817	899,49	1.910	1.426	1.086	1.223,02
11	770	810	1.573	1.177	898	974,04	2.101	1.568	1.195	1.296,52
12	840	884	1.716	1.284	980	1.048,59	2.292	1.711	1.304	1.370,02
13	910	958	1.859	1.391	1.062	1.123,14	2.483	1.854	1.412	1.443,52
14	980	1.032	2.002	1.498	1.144	1.197,69	2.674	1.996	1.521	1.517,02
15	1.050	1.106	2.145	1.605	1.225	1.272,24	2.865	2.139	1.629	1.590,52
16	1.120	1.180	2.288	1.712	1.307	1.346,79				
17	1.190	1.254	2.431	1.819	1.389	1.421,34				
18	1.260	1.328	2.574	1.926	1.470	1.495,89				
19	1.330	1.402	2.717	2.033	1.552	1.570,44				
20	1.400	1.476	2.860	2.140	1.634	1.644,99				
21	1.470	1.550	3.003	2.247	1.715	1.719,54				
22	1.540	1.624	3.146	2.354	1.797	1.794,09				
23	1.610	1.698	3.289	2.461	1.879	1.868,64				
24	1.680	1.772	3.432	2.568	1.960	1.943,19				

Precios para color blanco estándar RAL 9016.

Precios para carta de colores Zehnder +25%. Otros colores, consultar.



# Zehnder Jet X

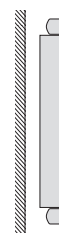
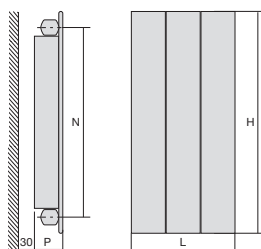

MODELO	NXV200	NXVL200
Altura H	2.000 mm	2.000 mm
Entre ejes N	1.932 mm	1.932 mm
Profundidad P	45 mm	58 mm
Exponente n	1,30	1,31

Recuerde pedir el Pack de Conexión

Elementos	Longitud L		Emisión EN 442 75/65/20 ΔT 50K W	Emisión Caldera condens. ΔT 40K W	Emisión Bomba de calor ΔT 32,5K W	Blanco RAL 9016 PVP €	Emisión EN 442 75/65/20 ΔT 50K W	Emisión Caldera condens. ΔT 40K W	Emisión Bomba de calor ΔT 32,5K W	Blanco RAL 9016 PVP €
	Nominal mm	Real mm								
2	140	144	306	229	175	318,46	410	306	233	678,42
3	210	218	459	343	262	398,84	615	459	350	757,73
4	280	292	612	458	350	479,22	820	612	466	837,04
5	350	366	765	572	437	559,60	1.025	765	583	916,35
6	420	440	918	687	524	639,98	1.230	918	700	995,66
7	490	514	1.071	801	612	720,36	1.435	1.071	816	1.074,97
8	560	588	1.224	916	699	800,74	1.640	1.224	933	1.154,28
9	630	662	1.377	1.030	787	881,12	1.845	1.377	1.049	1.233,59
10	700	736	1.530	1.145	874	961,50	2.050	1.530	1.166	1.312,90
11	770	810	1.683	1.259	961	1.041,88	2.255	1.683	1.283	1.392,21
12	840	884	1.836	1.374	1.049	1.122,26	2.460	1.836	1.399	1.471,52
13	910	958	1.989	1.488	1.136	1.202,64	2.665	1.990	1.516	1.550,83
14	980	1.032	2.142	1.603	1.224	1.283,02	2.870	2.143	1.632	1.630,14
15	1.050	1.106	2.295	1.717	1.311	1.363,40	3.075	2.296	1.749	1.709,45
16	1.120	1.180	2.448	1.832	1.398	1.443,78				
17	1.190	1.254	2.601	1.946	1.486	1.524,16				
18	1.260	1.328	2.754	2.061	1.573	1.604,54				
19	1.330	1.402	2.907	2.175	1.660	1.684,92				
20	1.400	1.476	3.060	2.289	1.748	1.765,30				
21	1.470	1.550	3.213	2.404	1.835	1.845,68				
22	1.540	1.624	3.366	2.518	1.923	1.926,06				
23	1.610	1.698	3.519	2.633	2.010	2.006,44				
24	1.680	1.772	3.672	2.747	2.097	2.086,82				

Precios para color blanco estándar RAL 9016.

Precios para carta de colores Zehnder +25%. Otros colores, consultar.



# Zehnder Jet X

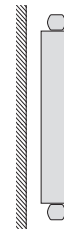
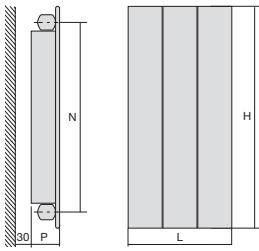

MODELO	NXV220	NXVL220
Altura H	2.200 mm	2.200 mm
Entre ejes N	2.132 mm	2.132 mm
Profundidad P	45 mm	58 mm
Exponente n	1,30	1,31

Recuerde pedir el Pack de Conexión

Elementos	Longitud L		Emisión EN 442 75/65/20 ΔT 50K W	Emisión Caldera condens. ΔT 40K W	Emisión Bomba de calor ΔT 32,5K W	Blanco RAL 9016 PVP €	Emisión EN 442 75/65/20 ΔT 50K W	Emisión Caldera condens. ΔT 40K W	Emisión Bomba de calor ΔT 32,5K W	Blanco RAL 9016 PVP €
	Nominal mm	Real mm								
2	140	144	336	251	192	333,74	436	325	248	721,74
3	210	218	504	377	288	419,94	654	488	372	806,86
4	280	292	672	503	384	506,14	872	651	496	891,98
5	350	366	840	628	480	592,34	1.090	814	620	977,10
6	420	440	1.008	754	576	678,54	1.308	976	744	1.062,22
7	490	514	1.176	880	672	764,74	1.526	1.139	868	1.147,34
8	560	588	1.344	1.006	768	850,94	1.744	1.302	992	1.232,46
9	630	662	1.512	1.131	864	937,14	1.962	1.465	1.116	1.317,58
10	700	736	1.680	1.257	960	1.023,34	2.180	1.627	1.240	1.402,70
11	770	810	1.848	1.383	1.056	1.109,54	2.398	1.790	1.364	1.487,82
12	840	884	2.016	1.508	1.152	1.195,74	2.616	1.953	1.488	1.572,94
13	910	958	2.184	1.634	1.247	1.281,94	2.834	2.116	1.612	1.658,06
14	980	1.032	2.352	1.760	1.343	1.368,14	3.052	2.278	1.736	1.743,18
15	1.050	1.106	2.520	1.885	1.439	1.454,34	3.270	2.441	1.860	1.828,30
16	1.120	1.180	2.688	2.011	1.535	1.540,54				
17	1.190	1.254	2.856	2.137	1.631	1.626,74				
18	1.260	1.328	3.024	2.263	1.727	1.712,94				
19	1.330	1.402	3.192	2.388	1.823	1.799,14				
20	1.400	1.476	3.360	2.514	1.919	1.885,34				
21	1.470	1.550	3.528	2.640	2.015	1.971,54				
22	1.540	1.624	3.696	2.765	2.111	2.057,74				
23	1.610	1.698	3.864	2.891	2.207	2.143,94				
24	1.680	1.772	4.032	3.017	2.303	2.230,14				

Precios para color blanco estándar RAL 9016.  
Precios para carta de colores Zehnder +25%. Otros colores, consultar.



# Zehnder Jet X

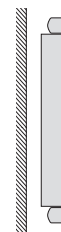
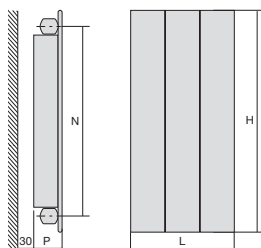

MODELO	NXV240	NXVL240
Altura H	2.400 mm	2.400 mm
Entre ejes N	2.332 mm	2.332 mm
Profundidad P	45 mm	58 mm
Exponente n	1,30	1,31

Recuerde pedir el Pack de Conexión

Elementos	Longitud L		Emisión EN 442 75/65/20 ΔT 50K W	Emisión Caldera condens. ΔT 40K W	Emisión Bomba de calor ΔT 32,5K W	Blanco RAL 9016 PVP €	Emisión EN 442 75/65/20 ΔT 50K W	Emisión Caldera condens. ΔT 40K W	Emisión Bomba de calor ΔT 32,5K W	Blanco RAL 9016 PVP €
	Nominal mm	Real mm								
2	140	144	366	274	209	349,13	462	345	263	765,11
3	210	218	549	411	314	441,14	693	517	394	856,06
4	280	292	732	548	418	533,15	924	690	526	947,01
5	350	366	915	685	523	625,16	1.155	862	657	1.037,96
6	420	440	1.098	822	627	717,17	1.386	1.035	788	1.128,91
7	490	514	1.281	958	732	809,18	1.617	1.207	920	1.219,86
8	560	588	1.464	1.095	836	901,19	1.848	1.380	1.051	1.310,81
9	630	662	1.647	1.232	941	993,20	2.079	1.552	1.182	1.401,76
10	700	736	1.830	1.369	1.045	1.085,21	2.310	1.724	1.314	1.492,71
11	770	810	2.013	1.506	1.150	1.177,22	2.541	1.897	1.445	1.583,66
12	840	884	2.196	1.643	1.254	1.269,23	2.772	2.069	1.577	1.674,61
13	910	958	2.379	1.780	1.359	1.361,24	3.003	2.242	1.708	1.765,56
14	980	1.032	2.562	1.917	1.463	1.453,25	3.234	2.414	1.839	1.856,51
15	1.050	1.106	2.745	2.054	1.568	1.545,26	3.465	2.587	1.971	1.947,46
16	1.120	1.180	2.928	2.191	1.672	1.637,27				
17	1.190	1.254	3.111	2.328	1.777	1.729,28				
18	1.260	1.328	3.294	2.465	1.882	1.821,29				
19	1.330	1.402	3.477	2.601	1.986	1.913,30				
20	1.400	1.476	3.660	2.738	2.091	2.005,31				
21	1.470	1.550	3.843	2.875	2.195	2.097,32				
22	1.540	1.624	4.026	3.012	2.300	2.189,33				
23	1.610	1.698	4.209	3.149	2.404	2.281,34				
24	1.680	1.772	4.392	3.286	2.509	2.373,35				

Precios para color blanco estándar RAL 9016.

Precios para carta de colores Zehnder +25%. Otros colores, consultar.



# Zehnder Jet X

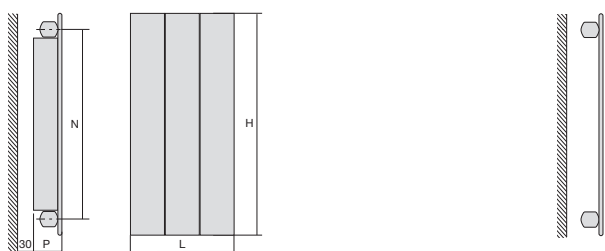

MODELO	NXV280
Altura H	2.800 mm
Entre ejes N	2.732 mm
Profundidad P	45 mm
Exponente n	1,30

Recuerde pedir el Pack de Conexión

Elementos	Longitud L		Emisión EN 442 75/65/20 $\Delta T$ 50K W	Emisión Caldera condens. $\Delta T$ 40K W	Emisión Bomba de calor $\Delta T$ 32,5K W	Blanco RAL 9016 PVP €	
	Nominal mm	Real mm					
2	140	144	428	320	244	382,94	
3	210	218	642	480	367	487,61	
4	280	292	856	640	489	592,28	
5	350	366	1.070	801	611	696,95	
6	420	440	1.284	961	733	801,62	
7	490	514	1.498	1.121	856	906,29	
8	560	588	1.712	1.281	978	1.010,96	
9	630	662	1.926	1.441	1.100	1.115,63	
10	700	736	2.140	1.601	1.222	1.220,30	
11	770	810	2.354	1.761	1.345	1.324,97	
12	840	884	2.568	1.921	1.467	1.429,64	
13	910	958	2.782	2.081	1.589	1.534,31	
14	980	1.032	2.996	2.242	1.711	1.638,98	
15	1.050	1.106	3.210	2.402	1.834	1.743,65	
16	1.120	1.180	3.424	2.562	1.956	1.848,32	
17	1.190	1.254	3.638	2.722	2.078	1.952,99	
18	1.260	1.328	3.852	2.882	2.200	2.057,66	
19	1.330	1.402	4.066	3.042	2.322	2.162,33	
20	1.400	1.476	4.280	3.202	2.445	2.267,00	
21	1.470	1.550	4.494	3.362	2.567	2.371,67	
22	1.540	1.624	4.708	3.523	2.689	2.476,34	
23	1.610	1.698	4.922	3.683	2.811	2.581,01	
24	1.680	1.772	5.136	3.843	2.934	2.685,68	

Zehnder Jet X

Precios para color blanco estándar RAL 9016.

Precios para carta de colores Zehnder +25%. Otros colores, consultar.





# Zehnder Jet X

## FIGURAS DE CONEXIÓN

**Conexiones Bitubo normales.** Sin suplemento de precio.

Misma mano

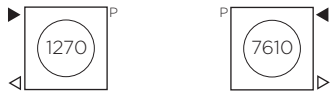

Cruzados

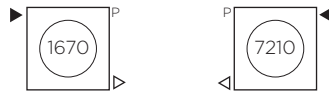

Lados opuestos

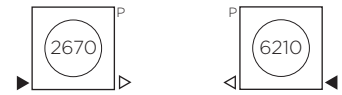

**Conexiones Bitubo especiales.** Con suplemento de precio **58,43 €.**

Desde abajo / hacia abajo

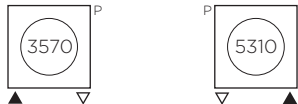

Desde arriba / hacia arriba



**Conexiones Mono-Bitubo especiales.** Con suplemento de precio **58,43 €.**

Racores juntos abajo\*  
Modelos horizontales

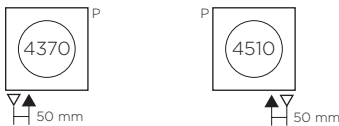

Racores juntos abajo\*\*  
Modelos verticales

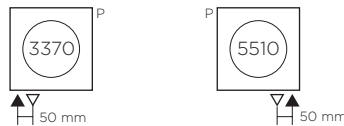

Desde abajo / hacia abajo

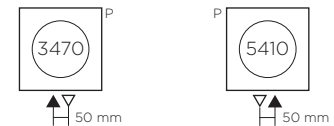

\*En los modelos horizontales la impulsión se hace por el racor interior del radiador.

\*\*En los modelos verticales la impulsión se hace por el racor exterior del radiador.

**Conexiones Monotubo.** Con suplemento de precio **58,43 €.**

Atención: respetar longitudes de las cañas.

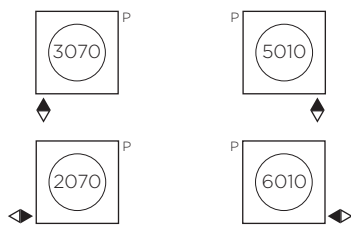

P = Purga V = Vaciado

Longitud de la caña	Radiadores verticales	Radiadores horizontales
Figuras 3070 y 5010 entrada de agua por el interior de la caña	L = 47 mm	L = 150 mm
Figuras 2070 y 6010 entrada de agua por el exterior de la caña	L = 150 mm	L = 47 mm

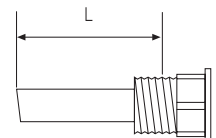

## MEDIDAS DE RACORES

Otras posiciones de racores, por ejemplo desde arriba hacia arriba, hacia atrás o adelante, pueden suministrarse bajo pedido, con suplemento de precio a consultar.

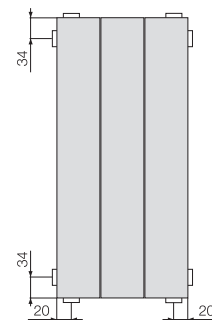
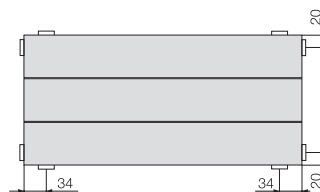

# Zehnder Jet X

## SOPORTES ESTÁNDAR

### Kit de soportes

Soportes a la pared incluidos en el embalaje. En el color del radiador solo con el pedido inicial.

Cada radiador lleva el Kit con su cantidad y tipo necesario de soportes murales. (A la pared).

### Kit de soportes adicional

Al pedir un Kit de soportes adicional hay que indicar para que radiador. Diferentes radiadores usan diferentes kits.

Blanco estándar (RAL 9016) PVP **54,67 €**

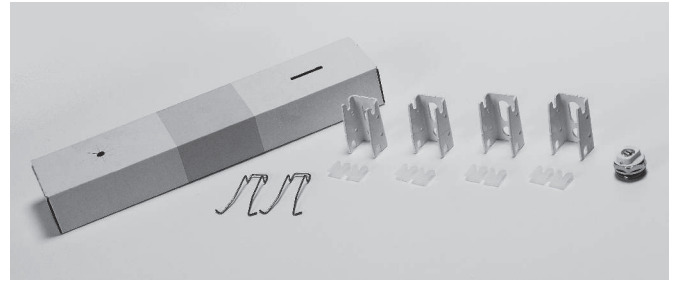

## SOPORTES SOLDADOS

Soldados en fábrica. Solo con el pedido del radiador.

Hasta modelos de 366 mm de altura sin pie, no es preciso soporte mural.

A partir de 440 mm de altura sin pie, se prevé soporte mural en la parte superior.

En el caso de pedirse soportes a medida, hay que definir las cotas A, B y C.

Recomendamos usar soportes fijos al suelo y soportes variables al techo.

El número y posición de los soportes se define en función de las medidas del radiador. Consultar.



FC

Dimensiones de la base: 100 x 50 mm.

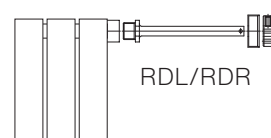

RDL/RDR

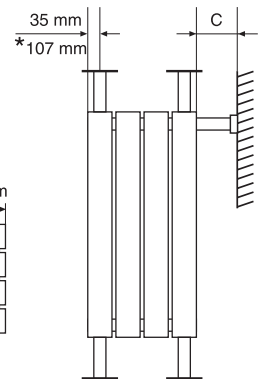
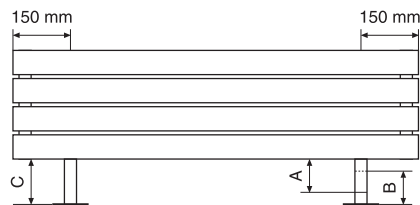

Tipo de soporte	Distancia al suelo/techo/pared		Referencia	PVP
	C mínimo mm	C máximo mm		
<b>Soportes de pie soldados</b>				
Altura regulable	150	200	FC200	<b>101,99</b>
	120	150	FC150	
A medida	A medida		FRCUS	<b>154,43</b>
<b>Soporte lateral atornillado</b>				
Regulable	60	170	RDL/RDR	<b>110,14</b>

\*A partir de 5 elementos.

# Zehnder Kleo

Esbozo atemporal





Un diseño más allá del tiempo. Zehnder Kleo es el radiador que sorprende por sus grandes prestaciones y su diseño ligero. Ya sea contra la pared, o como separador de ambientes, sus finos tubos redondos juegan con el espacio, el color y la luz transformando todo tipo de ambientes en entornos confortables y elegantes.



# Zehnder Kleo

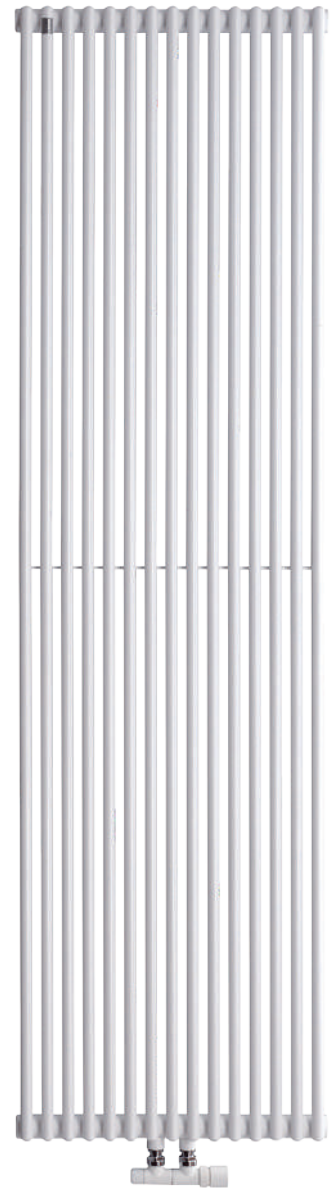

# Zehnder Kleo

## VERSIONES Y ACABADOS

Disponible en versiones simples y dobles,. Orientación vertical y horizontal (ver páginas 168 y 169).

Se suministra en color blanco (RAL 9016).

Disponible en los colores de la carta Zehnder (ver página 10).

Para otros colores o acabados, consultar.

### Ejecuciones especiales:

Radiadores en ángulo.

Radiadores curvos.

Longitudes o altura especiales.

Posición de racores especial y figuras de conexión distintas (ver página 200).

Alta presión.

Soportes de pie, de empotrar y soldados a consultar.

Separador de ambientes.

Todas las ejecuciones especiales deben ser consultadas para verificar disponibilidad y precio.

## SOPORTES

Soportes de pared incluidos en el embalaje. En el color del radiador solo con el pedido inicial.

Otros soportes de pie, de empotrar, soldados, disponibles bajo pedido.

### Kit de soportes a la pared adicional:

Blanco estándar (RAL 9016).

PVP **54,67 €**

## PACK DE CONEXIÓN

Incluye todas las piezas necesarias para la conexión (ver página 257).

### Bitubo. Modelos horizontales:

Para la conexión estándar

Juego de Válvula + Detentor. Tipo B.



Tipo B

### Monotubo. Modelos horizontales:

Válvula Monotubo Horizontal. Tipo N.

Solo bajo pedido. Necesita que el radiador se fabrique especialmente.

Hay que indicar en el pedido si es derecha o izquierda. (Ver página 200).



Tipo N

### Bitubo y Monotubo. Modelos Verticales:

Válvula Mono-Bitubo de conexión

inferior con entre ejes de 50 mm.

Instalaciones Bitubo; *bypass* cerrado.

Instalaciones Monotubo; *bypass* abierto.

Como estándar se suministra el tipo P (entrada por la derecha). El tipo Q bajo pedido.

La entrada derecha-izquierda no es relevante si la válvula no es termostática.



Tipo P



Tipo Q

Tipo de válvula	Acabado	Regulación manual PVP €	Regulación termostática PVP €
Todos los tipos de válvulas	Todos los acabados	<b>202,90</b>	<b>268,14</b>

# Zehnder Kleo

## ESPECIFICACIONES TÉCNICAS

Versión horizontal

Modelos KLH, simples

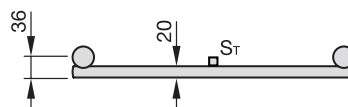
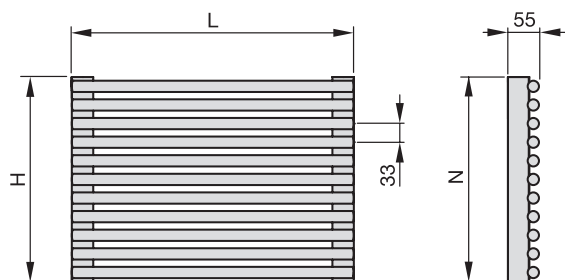

Modelos KLHD, dobles

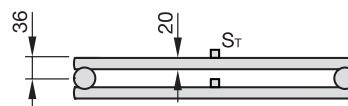
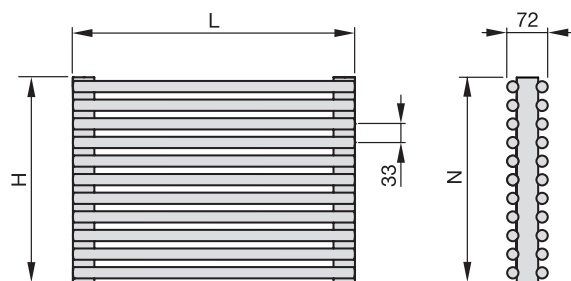

$L$  = Longitud.  $H$  = Altura.  $N$  = Distancia entre ejes.

# Zehnder Kleo

## ESPECIFICACIONES TÉCNICAS

### Versión vertical

#### Modelos KLV, simples

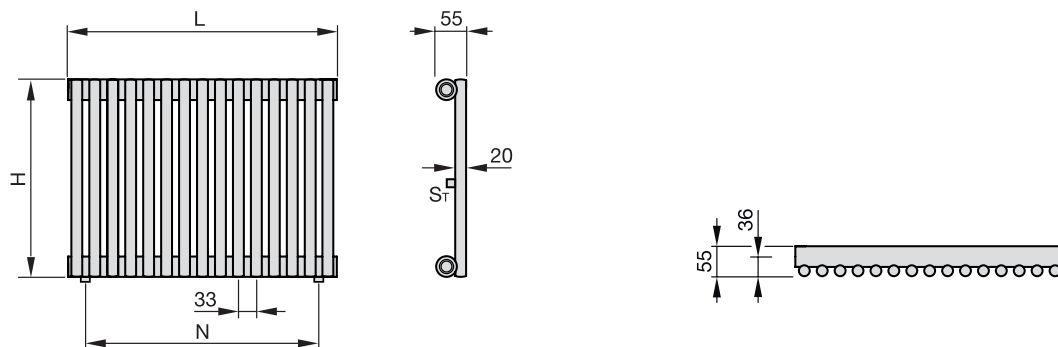

#### Modelos KLVD, dobles

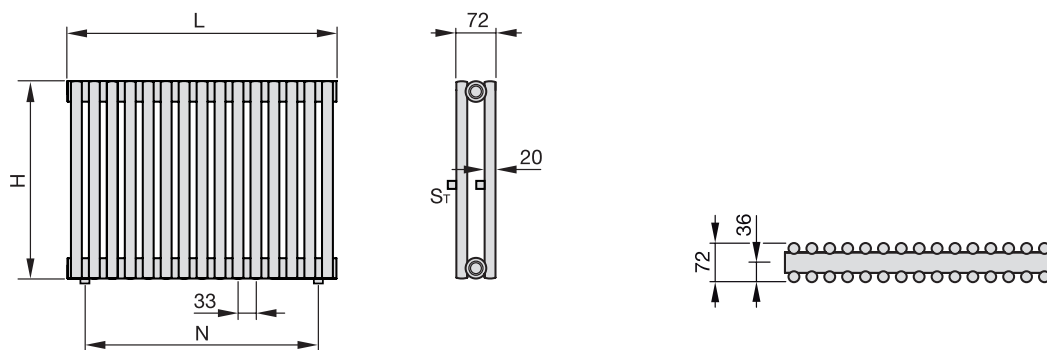

- Tubos redondos  $\varnothing 20 \times 1,25$  mm.
- Colector de tubo redondo  $\varnothing 38 \times 1,4$  mm.
- Presión máxima de servicio 4 bar. Presión de prueba en fábrica 5,2 bar.
- Paso X por elemento 33 mm.

L = Longitud. H = Altura. N = Distancia entre ejes.



# Zehnder Kleo

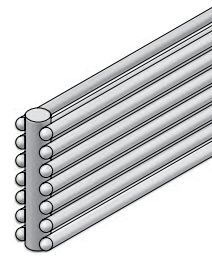
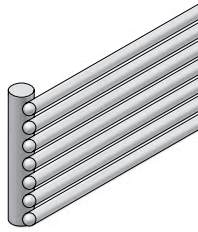
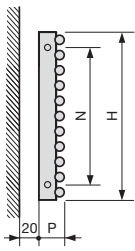

MODELO	KLH 022	KLHD 022
Altura H	231 mm	231 mm
Entre ejes N	193 mm	193 mm
Profundidad P	55 mm	72 mm
Exponente n	1,20	1,26

Recuerde pedir el Pack de Conexión

Longitud L mm	Emisión EN 442 75/65/20 ΔT 50K W	Emisión Caldera condens. ΔT 40K W	Emisión Bomba de calor ΔT 32,5K W	Blanco RAL 9016 PVP €	Emisión EN 442 75/65/20 ΔT 50K W	Emisión Caldera condens. ΔT 40K W	Emisión Bomba de calor ΔT 32,5K W	Blanco RAL 9016 PVP €
500	140	107	83	221,08	270	204	157	364,30
600	167	128	100	229,79	324	245	188	381,27
700	195	149	116	238,49	378	285	220	398,24
800	223	171	133	247,20	432	326	251	415,20
900	251	192	150	255,90	486	367	282	432,17
1.000	279	213	166	264,61	540	408	314	449,14
1.100	307	235	183	273,32	594	448	345	466,11
1.200	335	256	200	282,02	648	489	377	483,08
1.300	363	277	216	290,73	702	530	408	500,04
1.400	391	299	233	299,43	756	571	439	517,01
1.500	419	320	250	308,14	810	611	471	533,98
1.600	446	342	266	316,85	864	652	502	550,95
1.700	474	363	283	325,55	918	693	533	567,92
1.800	502	384	299	334,26	972	734	565	584,88
1.900	530	406	316	342,96	1.026	775	596	601,85
2.000	558	427	333	351,67	1.080	815	628	618,82
2.100	586	448	349	360,38	1.134	856	659	635,79
2.200	614	470	366	369,08	1.188	897	690	652,76
2.300	642	491	383	377,79	1.242	938	722	669,72
2.400	670	512	399	386,49	1.296	978	753	686,69
2.500	698	534	416	395,20	1.350	1.019	785	703,66
2.600	725	555	433	403,91	1.404	1.060	816	720,63
2.700	753	576	449	412,61	1.458	1.101	847	737,60
2.800	781	598	466	421,32	1.512	1.141	879	754,56
2.900	809	619	483	430,02	1.566	1.182	910	771,53
3.000	837	640	499	438,73	1.620	1.223	941	788,50

Precios para color blanco estándar RAL 9016.  
Precios para carta de colores Zehnder +25%. Otros colores, consultar.



# Zehnder Kleo

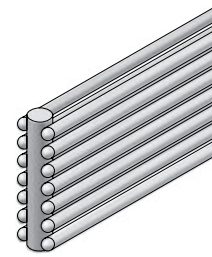
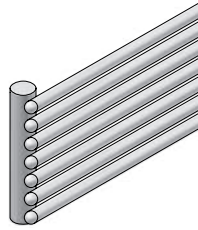
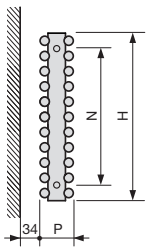

MODELO	KLH 028	KLHD 028
Altura H	297 mm	297 mm
Entre ejes N	259 mm	259 mm
Profundidad P	55 mm	72 mm
Exponente n	1,20	1,26

Recuerde pedir el Pack de Conexión

Longitud L mm	Emisión EN 442 75/65/20 ΔT 50K W	Emisión Caldera condens. ΔT 40K W	Emisión Bomba de calor ΔT 32,5K W	Blanco RAL 9016 PVP €	Emisión EN 442 75/65/20 ΔT 50K W	Emisión Caldera condens. ΔT 40K W	Emisión Bomba de calor ΔT 32,5K W	Blanco RAL 9016 PVP €
500	186	142	111	241,34	335	253	195	397,12
600	223	170	133	252,02	402	303	234	418,00
700	260	199	155	262,71	469	354	273	438,88
800	297	227	177	273,39	536	405	311	459,76
900	334	255	199	284,08	603	455	350	480,65
1.000	371	284	221	294,76	670	506	389	501,53
1.100	408	312	243	305,45	737	556	428	522,41
1.200	445	341	265	316,13	804	607	467	543,30
1.300	482	369	288	326,82	871	658	506	564,18
1.400	519	397	310	337,50	938	708	545	585,06
1.500	557	426	332	348,19	1.005	759	584	605,95
1.600	594	454	354	358,87	1.072	809	623	626,83
1.700	631	483	376	369,56	1.139	860	662	647,71
1.800	668	511	398	380,24	1.206	910	701	668,59
1.900	705	539	420	390,93	1.273	961	740	689,48
2.000	742	568	442	401,61	1.340	1.012	779	710,36
2.100	779	596	465	412,30	1.407	1.062	818	731,24
2.200	816	624	487	422,98	1.474	1.113	857	752,13
2.300	853	653	509	433,67	1.541	1.163	896	773,01
2.400	890	681	531	444,35	1.608	1.214	934	793,89
2.500	928	710	553	455,04	1.675	1.264	973	814,78
2.600	965	738	575	465,72	1.742	1.315	1.012	835,66
2.700	1.002	766	597	476,41	1.809	1.366	1.051	856,54
2.800	1.039	795	619	487,09	1.876	1.416	1.090	877,42
2.900	1.076	823	642	497,78	1.943	1.467	1.129	898,31
3.000	1.113	852	664	508,46	2.010	1.517	1.168	919,19

Precios para color blanco estándar RAL 9016.  
Precios para carta de colores Zehnder +25%. Otros colores, consultar.

# Zehnder Kleo

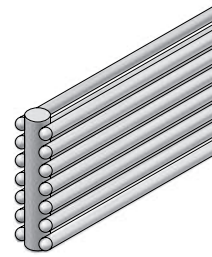
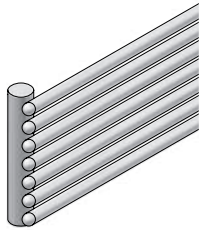
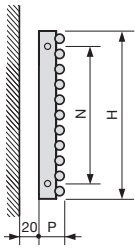

MODELO	KLH 035	KLHD 035
Altura H	363 mm	363 mm
Entre ejes N	325 mm	325 mm
Profundidad P	55 mm	72 mm
Exponente n	1,20	1,26

Recuerde pedir el Pack de Conexión

Longitud L mm	Emisión EN 442 75/65/20 $\Delta T$ 50K W	Emisión Caldera condens. $\Delta T$ 40K W	Emisión Bomba de calor $\Delta T$ 32,5K W	Blanco RAL 9016 PVP €	Emisión EN 442 75/65/20 $\Delta T$ 50K W	Emisión Caldera condens. $\Delta T$ 40K W	Emisión Bomba de calor $\Delta T$ 32,5K W	Blanco RAL 9016 PVP €
500	233	178	139	260,56	398	300	231	431,44
600	280	214	167	273,16	477	360	277	456,28
700	326	250	195	285,77	557	420	323	481,12
800	373	285	222	298,38	636	480	370	505,96
900	419	321	250	310,98	716	540	416	530,80
1.000	466	357	278	323,59	795	600	462	555,64
1.100	513	392	306	336,20	875	660	508	580,48
1.200	559	428	333	348,80	954	720	554	605,32
1.300	606	463	361	361,41	1.034	780	601	630,16
1.400	652	499	389	374,02	1.113	840	647	655,00
1.500	699	535	417	386,63	1.193	900	693	679,85
1.600	746	570	445	399,23	1.272	960	739	704,69
1.700	792	606	472	411,84	1.352	1.020	785	729,53
1.800	839	642	500	424,45	1.431	1.080	832	754,37
1.900	885	677	528	437,05	1.511	1.140	878	779,21
2.000	932	713	556	449,66	1.590	1.200	924	804,05
2.100	979	749	584	462,27	1.670	1.260	970	828,89
2.200	1.025	784	611	474,87	1.749	1.320	1.016	853,73
2.300	1.072	820	639	487,48	1.829	1.380	1.063	878,57
2.400	1.118	856	667	500,09	1.908	1.440	1.109	903,41
2.500	1.165	891	695	512,70	1.988	1.500	1.155	928,26
2.600	1.212	927	723	525,30	2.067	1.560	1.201	953,10
2.700	1.258	963	750	537,91	2.147	1.620	1.247	977,94
2.800	1.305	998	778	550,52	2.226	1.680	1.294	1.002,78
2.900	1.351	1.034	806	563,12	2.306	1.740	1.340	1.027,62
3.000	1.398	1.070	834	575,73	2.385	1.800	1.386	1.052,46

# Zehnder Kleo

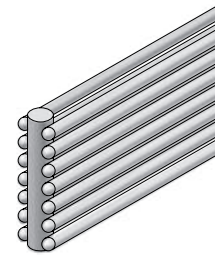
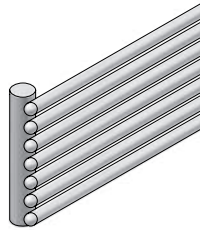
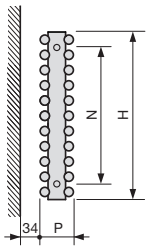

MODELO	KLH 042	KLHD 042
Altura H	429 mm	429 mm
Entre ejes N	391 mm	391 mm
Profundidad P	55 mm	72 mm
Exponente n	1,20	1,26

Recuerde pedir el Pack de Conexión

Longitud L	Emisión EN 442 75/65/20 ΔT 50K W	Emisión Caldera condens. ΔT 40K W	Emisión Bomba de calor ΔT 32,5K W	Blanco RAL 9016 PVP €	Emisión EN 442 75/65/20 ΔT 50K W	Emisión Caldera condens. ΔT 40K W	Emisión Bomba de calor ΔT 32,5K W	Blanco RAL 9016 PVP €
500	282	216	168	280,91	459	346	266	470,97
600	338	259	202	295,55	550	415	320	499,70
700	395	302	235	310,19	642	485	373	528,44
800	451	345	269	324,84	734	554	426	557,18
900	508	388	303	339,48	825	623	480	585,92
1.000	564	432	336	354,12	917	692	533	614,66
1.100	620	475	370	368,76	1.009	761	586	643,40
1.200	677	518	404	383,40	1.100	831	639	672,14
1.300	733	561	437	398,05	1.192	900	693	700,88
1.400	790	604	471	412,69	1.284	969	746	729,62
1.500	846	647	505	427,33	1.376	1.038	799	758,36
1.600	902	690	538	441,97	1.467	1.108	853	787,09
1.700	959	734	572	456,61	1.559	1.177	906	815,83
1.800	1.015	777	605	471,26	1.651	1.246	959	844,57
1.900	1.072	820	639	485,90	1.742	1.315	1.012	873,31
2.000	1.128	863	673	500,54	1.834	1.384	1.066	902,05
2.100	1.184	906	706	515,18	1.926	1.454	1.119	930,79
2.200	1.241	949	740	529,82	2.017	1.523	1.172	959,53
2.300	1.297	992	774	544,47	2.109	1.592	1.226	988,27
2.400	1.354	1.036	807	559,11	2.201	1.661	1.279	1.017,01
2.500	1.410	1.079	841	573,75	2.293	1.731	1.332	1.045,75
2.600	1.466	1.122	874	588,39	2.384	1.800	1.386	1.074,48
2.700	1.523	1.165	908	603,03	2.476	1.869	1.439	1.103,22
2.800	1.579	1.208	942	617,68	2.568	1.938	1.492	1.131,96
2.900	1.636	1.251	975	632,32	2.659	2.008	1.545	1.160,70
3.000	1.692	1.295	1.009	646,96	2.751	2.077	1.599	1.189,44

Precios para color blanco estándar RAL 9016.  
Precios para carta de colores Zehnder +25%. Otros colores, consultar.



# Zehnder Kleo

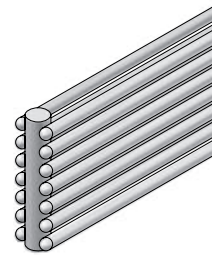
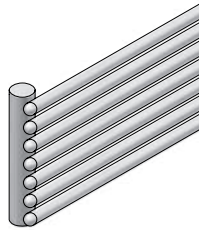
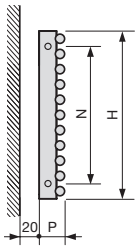

MODELO	KLH 048	KLHD 048
Altura H	495 mm	495 mm
Entre ejes N	457 mm	457 mm
Profundidad P	55 mm	72 mm
Exponente n	1,25	1,26

Recuerde pedir el Pack de Conexión

Longitud L mm	Emisión EN 442 75/65/20 $\Delta T$ 50K W	Emisión Caldera condens. $\Delta T$ 40K W	Emisión Bomba de calor $\Delta T$ 32,5K W	Blanco RAL 9016 PVP €	Emisión EN 442 75/65/20 $\Delta T$ 50K W	Emisión Caldera condens. $\Delta T$ 40K W	Emisión Bomba de calor $\Delta T$ 32,5K W	Blanco RAL 9016 PVP €
500	327	247	191	286,04	518	391	301	489,12
600	392	297	229	302,34	622	469	361	521,08
700	458	346	267	318,64	725	547	421	553,04
800	523	396	305	334,94	829	626	482	585,00
900	589	445	344	351,25	932	704	542	616,96
1.000	654	495	382	367,55	1.036	782	602	648,92
1.100	719	544	420	383,85	1.140	860	662	680,88
1.200	785	594	458	400,16	1.243	939	722	712,84
1.300	850	643	496	416,46	1.347	1.017	783	744,80
1.400	916	693	534	432,76	1.450	1.095	843	776,76
1.500	981	742	573	449,07	1.554	1.173	903	808,72
1.600	1.046	792	611	465,37	1.658	1.251	963	840,68
1.700	1.112	841	649	481,67	1.761	1.330	1.023	872,64
1.800	1.177	891	687	497,97	1.865	1.408	1.084	904,60
1.900	1.243	940	725	514,28	1.968	1.486	1.144	936,56
2.000	1.308	990	763	530,58	2.072	1.564	1.204	968,52
2.100	1.373	1.039	802	546,88	2.176	1.642	1.264	1.000,48
2.200	1.439	1.089	840	563,19	2.279	1.721	1.325	1.032,44
2.300	1.504	1.138	878	579,49	2.383	1.799	1.385	1.064,40
2.400	1.570	1.188	916	595,79	2.486	1.877	1.445	1.096,36
2.500	1.635	1.237	954	612,10	2.590	1.955	1.505	1.128,32
2.600	1.700	1.287	992	628,40	2.694	2.033	1.565	1.160,28
2.700	1.766	1.336	1.031	644,70	2.797	2.112	1.626	1.192,24
2.800	1.831	1.385	1.069	661,00	2.901	2.190	1.686	1.224,20
2.900	1.897	1.435	1.107	677,31	3.004	2.268	1.746	1.256,16
3.000	1.962	1.484	1.145	693,61	3.108	2.346	1.806	1.288,12

Precios para color blanco estándar RAL 9016.

Precios para carta de colores Zehnder +25%. Otros colores, consultar.



# Zehnder Kleo

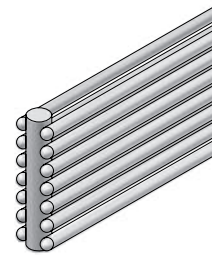
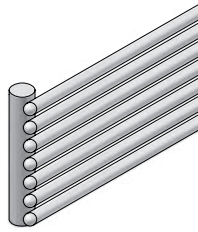
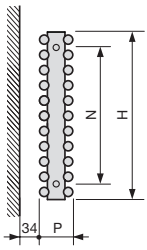

MODELO	KLH 055	KLHD 055
Altura H	561 mm	561 mm
Entre ejes N	523 mm	523 mm
Profundidad P	55 mm	72 mm
Exponente n	1,25	1,26

Recuerde pedir el Pack de Conexión

Longitud L mm	Emisión EN 442 75/65/20 ΔT 50K W	Emisión Caldera condens. ΔT 40K W	Emisión Bomba de calor ΔT 32,5K W	Blanco RAL 9016 PVP €	Emisión EN 442 75/65/20 ΔT 50K W	Emisión Caldera condens. ΔT 40K W	Emisión Bomba de calor ΔT 32,5K W	Blanco RAL 9016 PVP €
500	370	280	216	305,64	577	435	335	524,65
600	443	335	259	323,90	692	522	402	560,58
700	517	391	302	342,16	807	609	469	596,51
800	591	447	345	360,42	922	696	536	632,44
900	665	503	388	378,68	1.038	783	603	668,37
1.000	739	559	431	396,94	1.153	870	670	704,30
1.100	813	615	474	415,20	1.268	957	737	740,23
1.200	887	671	518	433,46	1.384	1.044	804	776,16
1.300	961	727	561	451,72	1.499	1.132	871	812,09
1.400	1.035	783	604	469,98	1.614	1.219	938	848,02
1.500	1.109	839	647	488,24	1.730	1.306	1.005	883,96
1.600	1.182	895	690	506,50	1.845	1.393	1.072	919,89
1.700	1.256	951	733	524,76	1.960	1.480	1.139	955,82
1.800	1.330	1.006	776	543,02	2.075	1.567	1.206	991,75
1.900	1.404	1.062	819	561,28	2.191	1.654	1.273	1.027,68
2.000	1.478	1.118	863	579,54	2.306	1.741	1.340	1.063,61
2.100	1.552	1.174	906	597,80	2.421	1.828	1.407	1.099,54
2.200	1.626	1.230	949	616,06	2.537	1.915	1.474	1.135,47
2.300	1.700	1.286	992	634,32	2.652	2.002	1.541	1.171,40
2.400	1.774	1.342	1.035	652,58	2.767	2.089	1.608	1.207,33
2.500	1.848	1.398	1.078	670,84	2.883	2.176	1.675	1.243,27
2.600	1.921	1.454	1.121	689,10	2.998	2.263	1.742	1.279,20
2.700	1.995	1.510	1.165	707,36	3.113	2.350	1.809	1.315,13
2.800	2.069	1.566	1.208	725,62	3.228	2.437	1.876	1.351,06
2.900	2.143	1.621	1.251	743,88	3.344	2.524	1.943	1.386,99
3.000	2.217	1.677	1.294	762,14	3.459	2.611	2.010	1.422,92

Precios para color blanco estándar RAL 9016.  
Precios para carta de colores Zehnder +25%. Otros colores, consultar.

# Zehnder Kleo

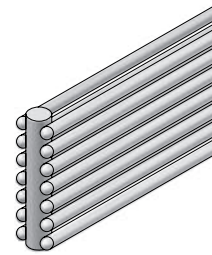
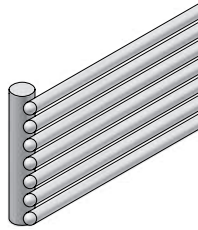
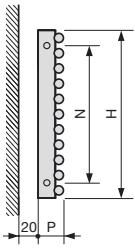

MODELO	KLH 061	KLHD 061
Altura H	627 mm	627 mm
Entre ejes N	589 mm	589 mm
Profundidad P	55 mm	72 mm
Exponente n	1,25	1,26

Recuerde pedir el Pack de Conexión

Longitud L mm	Emisión EN 442 75/65/20 $\Delta T$ 50K W	Emisión Caldera condens. $\Delta T$ 40K W	Emisión Bomba de calor $\Delta T$ 32,5K W	Blanco RAL 9016 PVP €	Emisión EN 442 75/65/20 $\Delta T$ 50K W	Emisión Caldera condens. $\Delta T$ 40K W	Emisión Bomba de calor $\Delta T$ 32,5K W	Blanco RAL 9016 PVP €
500	412	312	240	326,82	634	479	368	580,67
600	494	374	289	347,36	761	574	442	621,07
700	577	436	337	367,90	888	670	516	661,46
800	659	499	385	388,45	1.014	766	589	701,86
900	742	561	433	408,99	1.141	861	663	742,25
1.000	824	623	481	429,53	1.268	957	737	782,65
1.100	906	686	529	450,07	1.395	1.053	811	823,05
1.200	989	748	577	470,61	1.522	1.149	884	863,44
1.300	1.071	810	625	491,16	1.648	1.244	958	903,84
1.400	1.154	873	673	511,70	1.775	1.340	1.032	944,23
1.500	1.236	935	721	532,24	1.902	1.436	1.105	984,63
1.600	1.318	997	769	552,78	2.029	1.532	1.179	1.025,03
1.700	1.401	1.060	818	573,32	2.156	1.627	1.253	1.065,42
1.800	1.483	1.122	866	593,87	2.282	1.723	1.326	1.105,82
1.900	1.566	1.185	914	614,41	2.409	1.819	1.400	1.146,21
2.000	1.648	1.247	962	634,95	2.536	1.914	1.474	1.186,61
2.100	1.730	1.309	1.010	655,49	2.663	2.010	1.547	1.227,01
2.200	1.813	1.372	1.058	676,03	2.790	2.106	1.621	1.267,40
2.300	1.895	1.434	1.106	696,58	2.916	2.202	1.695	1.307,80
2.400	1.978	1.496	1.154	717,12	3.043	2.297	1.768	1.348,19
2.500	2.060	1.559	1.202	737,66	3.170	2.393	1.842	1.388,59
2.600	2.142	1.621	1.250	758,20	3.297	2.489	1.916	1.428,99
2.700	2.225	1.683	1.298	778,74	3.424	2.584	1.990	1.469,38
2.800	2.307	1.746	1.347	799,29	3.550	2.680	2.063	1.509,78
2.900	2.390	1.808	1.395	819,83	3.677	2.776	2.137	1.550,17
3.000	2.472	1.870	1.443	840,37	3.804	2.872	2.211	1.590,57

Precios para color blanco estándar RAL 9016.

Precios para carta de colores Zehnder +25%. Otros colores, consultar.



# Zehnder Kleo

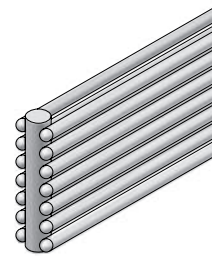
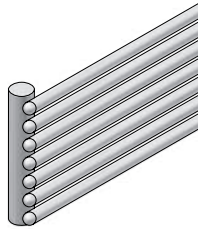
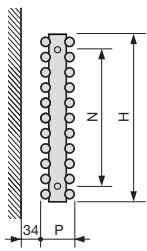

MODELO	KLH 068	KLHD 068
Altura H	693 mm	693 mm
Entre ejes N	655 mm	655 mm
Profundidad P	55 mm	72 mm
Exponente n	1,25	1,26

Recuerde pedir el Pack de Conexión

Longitud L mm	Emisión EN 442 75/65/20 $\Delta T$ 50K W	Emisión Caldera condens. $\Delta T$ 40K W	Emisión Bomba de calor $\Delta T$ 32,5K W	Blanco RAL 9016 PVP €	Emisión EN 442 75/65/20 $\Delta T$ 50K W	Emisión Caldera condens. $\Delta T$ 40K W	Emisión Bomba de calor $\Delta T$ 32,5K W	Blanco RAL 9016 PVP €
500	455	344	265	358,83	691	522	402	601,61
600	545	413	318	381,40	829	626	482	645,96
700	636	481	371	403,98	967	730	562	690,31
800	727	550	424	426,56	1.106	835	642	734,66
900	818	619	477	449,14	1.244	939	723	779,01
1.000	909	688	531	471,72	1.382	1.043	803	823,36
1.100	1.000	757	584	494,30	1.520	1.148	883	867,71
1.200	1.091	825	637	516,88	1.658	1.252	964	912,06
1.300	1.182	894	690	539,46	1.797	1.356	1.044	956,41
1.400	1.273	963	743	562,04	1.935	1.461	1.124	1.000,76
1.500	1.364	1.032	796	584,62	2.073	1.565	1.205	1.045,12
1.600	1.454	1.100	849	607,19	2.211	1.669	1.285	1.089,47
1.700	1.545	1.169	902	629,77	2.349	1.774	1.365	1.133,82
1.800	1.636	1.238	955	652,35	2.488	1.878	1.446	1.178,17
1.900	1.727	1.307	1.008	674,93	2.626	1.982	1.526	1.222,52
2.000	1.818	1.375	1.061	697,51	2.764	2.087	1.606	1.266,87
2.100	1.909	1.444	1.114	720,09	2.902	2.191	1.687	1.311,22
2.200	2.000	1.513	1.167	742,67	3.040	2.295	1.767	1.355,57
2.300	2.091	1.582	1.220	765,25	3.179	2.400	1.847	1.399,92
2.400	2.182	1.651	1.273	787,83	3.317	2.504	1.927	1.444,27
2.500	2.273	1.719	1.326	810,41	3.455	2.608	2.008	1.488,63
2.600	2.363	1.788	1.379	832,98	3.593	2.713	2.088	1.532,98
2.700	2.454	1.857	1.432	855,56	3.731	2.817	2.168	1.577,33
2.800	2.545	1.926	1.485	878,14	3.870	2.921	2.249	1.621,68
2.900	2.636	1.994	1.539	900,72	4.008	3.026	2.329	1.666,03
3.000	2.727	2.063	1.592	923,30	4.146	3.130	2.409	1.710,38

Precios para color blanco estándar RAL 9016.  
Precios para carta de colores Zehnder +25%. Otros colores, consultar.





# Zehnder Kleo

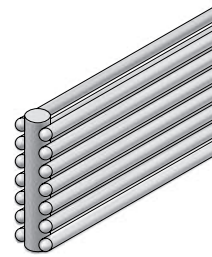
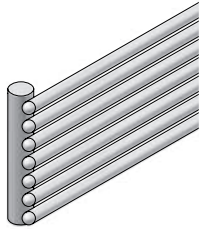
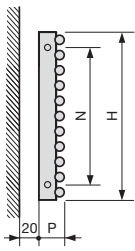

MODELO	KLH 075	KLHD 075
Altura H	759 mm	759 mm
Entre ejes N	721 mm	721 mm
Profundidad P	55 mm	72 mm
Exponente n	1,25	1,26

Recuerde pedir el Pack de Conexión

Longitud L mm	Emisión EN 442 75/65/20 $\Delta T$ 50K W	Emisión Caldera condens. $\Delta T$ 40K W	Emisión Bomba de calor $\Delta T$ 32,5K W	Blanco RAL 9016 PVP €	Emisión EN 442 75/65/20 $\Delta T$ 50K W	Emisión Caldera condens. $\Delta T$ 40K W	Emisión Bomba de calor $\Delta T$ 32,5K W	Blanco RAL 9016 PVP €
500	497	376	290	378,26	747	564	434	635,91
600	596	451	348	403,14	896	677	521	684,93
700	695	526	406	428,01	1.046	789	608	733,95
800	794	601	464	452,89	1.195	902	695	782,97
900	894	676	522	477,76	1.345	1.015	781	831,99
1.000	993	751	580	502,64	1.494	1.128	868	881,01
1.100	1.092	826	638	527,52	1.643	1.241	955	930,03
1.200	1.192	902	695	552,39	1.793	1.353	1.042	979,05
1.300	1.291	977	753	577,27	1.942	1.466	1.129	1.028,07
1.400	1.390	1.052	811	602,14	2.092	1.579	1.215	1.077,09
1.500	1.490	1.127	869	627,02	2.241	1.692	1.302	1.126,11
1.600	1.589	1.202	927	651,90	2.390	1.805	1.389	1.175,13
1.700	1.688	1.277	985	676,77	2.540	1.917	1.476	1.224,15
1.800	1.787	1.352	1.043	701,65	2.689	2.030	1.563	1.273,17
1.900	1.887	1.427	1.101	726,52	2.839	2.143	1.650	1.322,19
2.000	1.986	1.503	1.159	751,40	2.988	2.256	1.736	1.371,21
2.100	2.085	1.578	1.217	776,28	3.137	2.368	1.823	1.420,23
2.200	2.185	1.653	1.275	801,15	3.287	2.481	1.910	1.469,25
2.300	2.284	1.728	1.333	826,03	3.436	2.594	1.997	1.518,27
2.400	2.383	1.803	1.391	850,90	3.586	2.707	2.084	1.567,29
2.500	2.483	1.878	1.449	875,78	3.735	2.820	2.171	1.616,31
2.600	2.582	1.953	1.507	900,66	3.884	2.932	2.257	1.665,33
2.700	2.681	2.029	1.565	925,53	4.034	3.045	2.344	1.714,35
2.800	2.780	2.104	1.623	950,41	4.183	3.158	2.431	1.763,37
2.900	2.880	2.179	1.681	975,28	4.333	3.271	2.518	1.812,39
3.000	2.979	2.254	1.739	1.000,16	4.482	3.383	2.605	1.861,41

Precios para color blanco estándar RAL 9016.

Precios para carta de colores Zehnder +25%. Otros colores, consultar.



# Zehnder Kleo

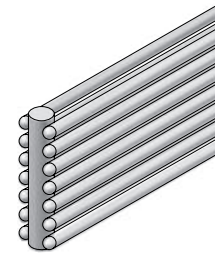
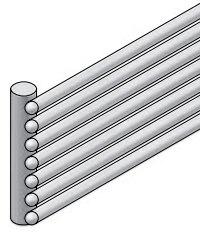
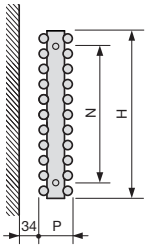

MODELO	KLH 081	KLHD 081
Altura H	825 mm	825 mm
Entre ejes N	787 mm	787 mm
Profundidad P	55 mm	72 mm
Exponente n	1,25	1,26

Recuerde pedir el Pack de Conexión

Longitud L mm	Emisión EN 442 75/65/20 $\Delta T$ 50K W	Emisión Caldera condens. $\Delta T$ 40K W	Emisión Bomba de calor $\Delta T$ 32,5K W	Blanco RAL 9016 PVP €	Emisión EN 442 75/65/20 $\Delta T$ 50K W	Emisión Caldera condens. $\Delta T$ 40K W	Emisión Bomba de calor $\Delta T$ 32,5K W	Blanco RAL 9016 PVP €
500	538	407	314	397,38	802	605	466	667,70
600	646	488	377	423,97	962	727	559	719,90
700	753	570	440	450,56	1.123	848	652	772,10
800	861	651	502	477,15	1.283	969	746	824,30
900	968	733	565	503,75	1.444	1.090	839	876,51
1.000	1.076	814	628	530,34	1.604	1.211	932	928,71
1.100	1.184	896	691	556,93	1.764	1.332	1.025	980,91
1.200	1.291	977	754	583,53	1.925	1.453	1.119	1.033,12
1.300	1.399	1.058	816	610,12	2.085	1.574	1.212	1.085,32
1.400	1.506	1.140	879	636,71	2.246	1.695	1.305	1.137,52
1.500	1.614	1.221	942	663,31	2.406	1.816	1.398	1.189,73
1.600	1.722	1.303	1.005	689,90	2.566	1.937	1.491	1.241,93
1.700	1.829	1.384	1.068	716,49	2.727	2.058	1.585	1.294,13
1.800	1.937	1.465	1.130	743,08	2.887	2.180	1.678	1.346,33
1.900	2.044	1.547	1.193	769,68	3.048	2.301	1.771	1.398,54
2.000	2.152	1.628	1.256	796,27	3.208	2.422	1.864	1.450,74
2.100	2.260	1.710	1.319	822,86	3.368	2.543	1.957	1.502,94
2.200	2.367	1.791	1.382	849,46	3.529	2.664	2.051	1.555,15
2.300	2.475	1.872	1.444	876,05	3.689	2.785	2.144	1.607,35
2.400	2.582	1.954	1.507	902,64	3.850	2.906	2.237	1.659,55
2.500	2.690	2.035	1.570	929,24	4.010	3.027	2.330	1.711,76
2.600	2.798	2.117	1.633	955,83	4.170	3.148	2.424	1.763,96
2.700	2.905	2.198	1.696	982,42	4.331	3.269	2.517	1.816,16
2.800	3.013	2.279	1.758	1.009,01	4.491	3.390	2.610	1.868,36
2.900	3.120	2.361	1.821	1.035,61	4.652	3.512	2.703	1.920,57
3.000	3.228	2.442	1.884	1.062,20	4.812	3.633	2.796	1.972,77

Precios para color blanco estándar RAL 9016.  
Precios para carta de colores Zehnder +25%. Otros colores, consultar.



# Zehnder Kleo

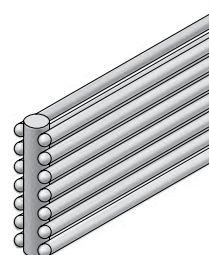
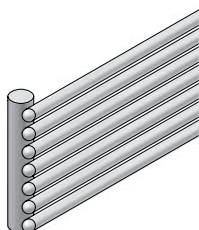
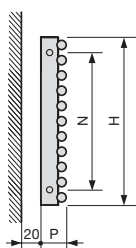

MODELO	KLH 088	KLHD 088
Altura H	891 mm	891 mm
Entre ejes N	853 mm	853 mm
Profundidad P	55 mm	72 mm
Exponente n	1,25	1,26

Recuerde pedir el Pack de Conexión

Longitud L mm	Emisión EN 442 75/65/20 ΔT 50K W	Emisión Caldera condens. ΔT 40K W	Emisión Bomba de calor ΔT 32,5K W	Blanco RAL 9016 PVP €	Emisión EN 442 75/65/20 ΔT 50K W	Emisión Caldera condens. ΔT 40K W	Emisión Bomba de calor ΔT 32,5K W	Blanco RAL 9016 PVP €
500	580	438	338	415,09	857	647	498	703,63
600	695	526	406	443,97	1.028	776	597	760,39
700	811	614	474	472,86	1.199	905	697	817,15
800	927	702	541	501,75	1.370	1.035	796	873,90
900	1.043	789	609	530,64	1.542	1.164	896	930,66
1.000	1.159	877	676	559,53	1.713	1.293	995	987,42
1.100	1.275	965	744	588,42	1.884	1.422	1.095	1.044,18
1.200	1.391	1.052	812	617,31	2.056	1.552	1.195	1.100,94
1.300	1.507	1.140	879	646,20	2.227	1.681	1.294	1.157,69
1.400	1.623	1.228	947	675,09	2.398	1.810	1.394	1.214,45
1.500	1.739	1.315	1.015	703,98	2.570	1.940	1.493	1.271,21
1.600	1.854	1.403	1.082	732,86	2.741	2.069	1.593	1.327,97
1.700	1.970	1.491	1.150	761,75	2.912	2.198	1.692	1.384,73
1.800	2.086	1.578	1.218	790,64	3.083	2.328	1.792	1.441,48
1.900	2.202	1.666	1.285	819,53	3.255	2.457	1.891	1.498,24
2.000	2.318	1.754	1.353	848,42	3.426	2.586	1.991	1.555,00
2.100	2.434	1.841	1.421	877,31	3.597	2.716	2.090	1.611,76
2.200	2.550	1.929	1.488	906,20	3.769	2.845	2.190	1.668,52
2.300	2.666	2.017	1.556	935,09	3.940	2.974	2.290	1.725,27
2.400	2.782	2.105	1.623	963,98	4.111	3.104	2.389	1.782,03
2.500	2.898	2.192	1.691	992,87	4.283	3.233	2.489	1.838,79
2.600	3.013	2.280	1.759	1.021,75	4.454	3.362	2.588	1.895,55
2.700	3.129	2.368	1.826	1.050,64	4.625	3.492	2.688	1.952,31
2.800	3.245	2.455	1.894	1.079,53	4.796	3.621	2.787	2.009,06
2.900	3.361	2.543	1.962	1.108,42	4.968	3.750	2.887	2.065,82
3.000	3.477	2.631	2.029	1.137,31	5.139	3.879	2.986	2.122,58

Precios para color blanco estándar RAL 9016.

Precios para carta de colores Zehnder +25%. Otros colores, consultar.



# Zehnder Kleo

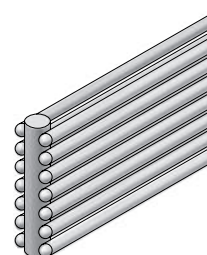
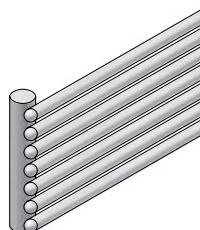
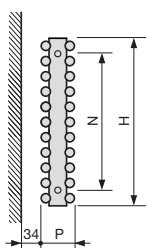

MODELO	KLH 094	KLHD 094
Altura H	957 mm	957 mm
Entre ejes N	919 mm	919 mm
Profundidad P	55 mm	72 mm
Exponente n	1,25	1,26

Recuerde pedir el Pack de Conexión

Longitud L mm	Emisión EN 442 75/65/20 $\Delta T$ 50K W	Emisión Caldera condens. $\Delta T$ 40K W	Emisión Bomba de calor $\Delta T$ 32,5K W	Blanco RAL 9016 PVP €	Emisión EN 442 75/65/20 $\Delta T$ 50K W	Emisión Caldera condens. $\Delta T$ 40K W	Emisión Bomba de calor $\Delta T$ 32,5K W	Blanco RAL 9016 PVP €
500	621	469	362	437,16	911	687	529	738,77
600	745	563	435	467,67	1.093	825	635	798,80
700	869	657	507	498,18	1.275	962	741	858,84
800	993	751	579	528,69	1.457	1.100	847	918,88
900	1.117	845	652	559,20	1.639	1.237	952	978,91
1.000	1.241	939	724	589,71	1.821	1.375	1.058	1.038,95
1.100	1.365	1.033	797	620,22	2.003	1.512	1.164	1.098,99
1.200	1.489	1.127	869	650,73	2.185	1.650	1.270	1.159,02
1.300	1.613	1.221	942	681,24	2.367	1.787	1.376	1.219,06
1.400	1.737	1.315	1.014	711,75	2.549	1.925	1.482	1.279,10
1.500	1.862	1.408	1.086	742,26	2.732	2.062	1.587	1.339,14
1.600	1.986	1.502	1.159	772,77	2.914	2.199	1.693	1.399,17
1.700	2.110	1.596	1.231	803,28	3.096	2.337	1.799	1.459,21
1.800	2.234	1.690	1.304	833,79	3.278	2.474	1.905	1.519,25
1.900	2.358	1.784	1.376	864,30	3.460	2.612	2.011	1.579,28
2.000	2.482	1.878	1.449	894,81	3.642	2.749	2.116	1.639,32
2.100	2.606	1.972	1.521	925,32	3.824	2.887	2.222	1.699,36
2.200	2.730	2.066	1.593	955,83	4.006	3.024	2.328	1.759,39
2.300	2.854	2.160	1.666	986,34	4.188	3.162	2.434	1.819,43
2.400	2.978	2.253	1.738	1.016,85	4.370	3.299	2.540	1.879,47
2.500	3.103	2.347	1.811	1.047,36	4.553	3.437	2.646	1.939,51
2.600	3.227	2.441	1.883	1.077,87	4.735	3.574	2.751	1.999,54
2.700	3.351	2.535	1.956	1.108,38	4.917	3.712	2.857	2.059,58
2.800	3.475	2.629	2.028	1.138,89	5.099	3.849	2.963	2.119,62
2.900	3.599	2.723	2.100	1.169,40	5.281	3.987	3.069	2.179,65
3.000	3.723	2.817	2.173	1.199,91	5.463	4.124	3.175	2.239,69

Precios para color blanco estándar RAL 9016.  
Precios para carta de colores Zehnder +25%. Otros colores, consultar.



# Zehnder Kleo

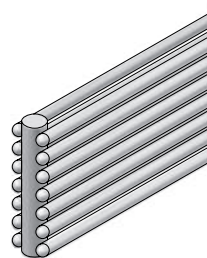
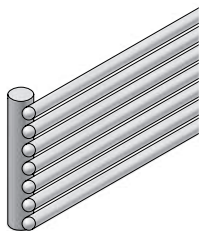
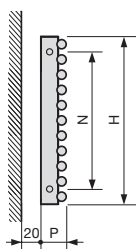

MODELO	KLH 147	KLHD 147
Altura H	1.485 mm	1.485 mm
Entre ejes N	1.447 mm	1.447 mm
Profundidad P	55 mm	72 mm
Exponente n	1,24	1,26

Recuerde pedir el Pack de Conexión

Longitud L mm	Emisión EN 442 75/65/20 $\Delta T$ 50K W	Emisión Caldera condens. $\Delta T$ 40K W	Emisión Bomba de calor $\Delta T$ 32,5K W	Blanco RAL 9016 PVP €	Emisión EN 442 75/65/20 $\Delta T$ 50K W	Emisión Caldera condens. $\Delta T$ 40K W	Emisión Bomba de calor $\Delta T$ 32,5K W	Blanco RAL 9016 PVP €
500	941	714	552	631,64	1.327	1.001	771	1.103,90
600	1.129	856	662	677,53	1.592	1.202	925	1.194,26
700	1.317	999	772	723,42	1.857	1.402	1.079	1.284,62
800	1.506	1.142	883	769,31	2.122	1.602	1.233	1.374,98
900	1.694	1.284	993	815,20	2.388	1.802	1.388	1.465,34
1.000	1.882	1.427	1.103	861,09	2.653	2.003	1.542	1.555,70

Precios para color blanco estándar RAL 9016.

Precios para carta de colores Zehnder +25%. Otros colores, consultar.



# Zehnder Kleo

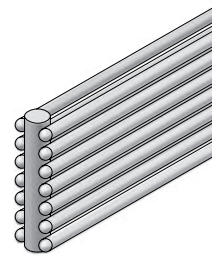
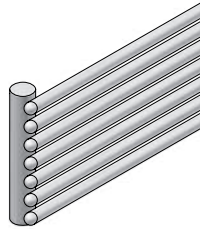
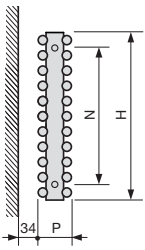

MODELO	KLH 160	KLHD 160
Altura H	1.617 mm	1.617 mm
Entre ejes N	1.579 mm	1.579 mm
Profundidad P	55 mm	72 mm
Exponente n	1,24	1,26

Recuerde pedir el Pack de Conexión

Longitud L	Emisión EN 442 75/65/20 ΔT 50K W	Emisión Caldera condens. ΔT 40K W	Emisión Bomba de calor ΔT 32,5K W	Blanco RAL 9016 PVP €	Emisión EN 442 75/65/20 ΔT 50K W	Emisión Caldera condens. ΔT 40K W	Emisión Bomba de calor ΔT 32,5K W	Blanco RAL 9016 PVP €
500	1.019	773	597	684,49	1.427	1.077	829	1.177,80
600	1.223	927	717	734,32	1.712	1.293	995	1.276,00
700	1.427	1.082	836	784,15	1.998	1.508	1.161	1.374,21
800	1.630	1.236	956	833,98	2.283	1.724	1.327	1.472,42
900	1.834	1.391	1.075	883,81	2.569	1.939	1.493	1.570,63
1.000	2.038	1.545	1.195	933,64	2.854	2.155	1.659	1.668,84

Precios para color blanco estándar RAL 9016.  
Precios para carta de colores Zehnder +25%. Otros colores, consultar.



# Zehnder Kleo

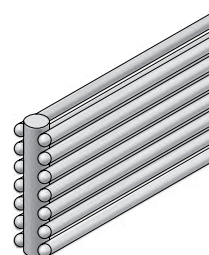
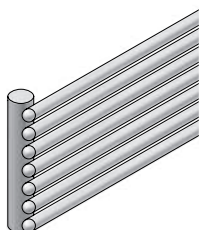
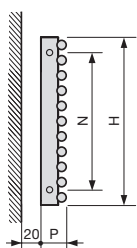

MODELO	KLH 180	KLHD 180
Altura H	1.815 mm	1.815 mm
Entre ejes N	1.777 mm	1.777 mm
Profundidad P	55 mm	72 mm
Exponente n	1,25	1,26

Recuerde pedir el Pack de Conexión

Longitud L mm	Emisión EN 442 75/65/20 ΔT 50K W	Emisión Caldera condens. ΔT 40K W	Emisión Bomba de calor ΔT 32,5K W	Blanco RAL 9016 PVP €	Emisión EN 442 75/65/20 ΔT 50K W	Emisión Caldera condens. ΔT 40K W	Emisión Bomba de calor ΔT 32,5K W	Blanco RAL 9016 PVP €
500	1.134	858	662	763,64	1.576	1.190	916	1.288,59
600	1.360	1.029	794	819,34	1.891	1.428	1.099	1.398,54
700	1.587	1.201	926	875,05	2.206	1.666	1.282	1.508,50
800	1.814	1.372	1.058	930,75	2.522	1.904	1.465	1.618,46
900	2.040	1.544	1.191	986,46	2.837	2.142	1.649	1.728,42
1.000	2.267	1.715	1.323	1.042,16	3.152	2.379	1.832	1.838,38

Precios para color blanco estándar RAL 9016.

Precios para carta de colores Zehnder +25%. Otros colores, consultar.



# Zehnder Kleo

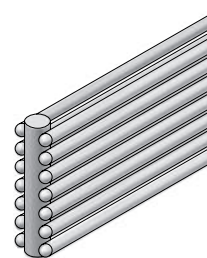
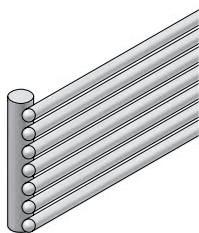
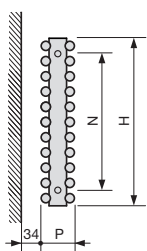

MODELO	KLH 200	KLHD 200
Altura H	2.013 mm	2.013 mm
Entre ejes N	1.975 mm	1.975 mm
Profundidad P	55 mm	72 mm
Exponente n	1,23	1,26

Recuerde pedir el Pack de Conexión

Longitud L mm	Emisión EN 442 75/65/20 $\Delta T$ 50K W	Emisión Caldera condens. $\Delta T$ 40K W	Emisión Bomba de calor $\Delta T$ 32,5K W	Blanco RAL 9016 PVP €	Emisión EN 442 75/65/20 $\Delta T$ 50K W	Emisión Caldera condens. $\Delta T$ 40K W	Emisión Bomba de calor $\Delta T$ 32,5K W	Blanco RAL 9016 PVP €
500	1.246	947	734	842,88	1.722	1.300	1.001	1.399,40
600	1.495	1.136	880	904,49	2.066	1.560	1.201	1.521,12
700	1.744	1.326	1.027	966,09	2.411	1.820	1.401	1.642,84
800	1.994	1.515	1.174	1.027,70	2.755	2.080	1.601	1.764,56
900	2.243	1.704	1.320	1.089,30	3.100	2.340	1.801	1.886,28
1.000	2.492	1.894	1.467	1.150,91	3.444	2.600	2.001	2.008,00

Precios para color blanco estándar RAL 9016.  
Precios para carta de colores Zehnder +25%. Otros colores, consultar.





# Zehnder Kleo

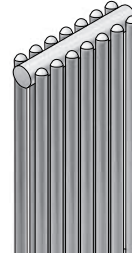
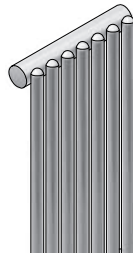
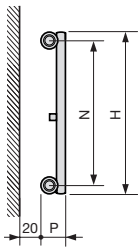

MODELO	KLV 050	KLVD 050
Altura H	500 mm	500 mm
Entre ejes N	462 mm	462 mm
Profundidad P	55 mm	72 mm
Exponente n	1,26	1,28

Recuerde pedir el Pack de Conexión

Longitud L		Emisión EN 442 75/65/20 ΔT 50K W	Emisión Caldera condens. ΔT 40K W	Emisión Bomba de calor ΔT 32,5K W	Blanco RAL 9016 PVP €	Emisión EN 442 75/65/20 ΔT 50K W	Emisión Caldera condens. ΔT 40K W	Emisión Bomba de calor ΔT 32,5K W	Blanco RAL 9016 PVP €
Elementos	mm								
7	231	156	118	91	222,64	240	180	138	390,63
8	264	178	135	104	232,06	274	206	158	409,50
9	297	201	152	117	241,48	309	232	178	428,37
10	330	223	168	130	250,90	343	258	198	447,24
11	363	245	185	143	260,32	377	284	217	466,11
12	396	268	202	156	269,74	412	309	237	484,98
13	429	290	219	168	279,16	446	335	257	503,85
14	462	312	236	181	288,58	480	361	277	522,72
15	495	335	253	194	298,00	515	387	296	541,59
16	528	357	269	207	307,42	549	412	316	560,46
17	561	379	286	220	316,84	583	438	336	579,33
18	594	401	303	233	326,26	617	464	356	598,20
19	627	424	320	246	335,68	652	490	375	617,07
20	660	446	337	259	345,10	686	516	395	635,94
21	693	468	354	272	354,52	720	541	415	654,81
22	726	491	370	285	363,94	755	567	435	673,68
23	759	513	387	298	373,36	789	593	455	692,55
24	792	535	404	311	382,78	823	619	474	711,42
25	825	558	421	324	392,20	858	644	494	730,29
26	858	580	438	337	401,62	892	670	514	749,16
27	891	602	455	350	411,04	926	696	534	768,03
28	924	624	471	363	420,46	960	722	553	786,90
29	957	647	488	376	429,88	995	748	573	805,77
30	990	669	505	389	439,30	1.029	773	593	824,64
31	1.023	691	522	402	448,72	1.063	799	613	843,51
32	1.056	714	539	415	458,14	1.098	825	632	862,38
33	1.089	736	556	428	467,56	1.132	851	652	881,25
34	1.122	758	572	441	476,98	1.166	876	672	900,12
35	1.155	781	589	454	486,40	1.201	902	692	918,99
36	1.188	803	606	467	495,82	1.235	928	711	937,86
37	1.221	825	623	479	505,24	1.269	954	731	956,73
38	1.254	847	640	492	514,66	1.303	980	751	975,60
39	1.287	870	657	505	524,08	1.338	1.005	771	994,47
40	1.320	892	673	518	533,50	1.372	1.031	790	1.013,34
41	1.353	914	690	531	542,92	1.406	1.057	810	1.032,21
42	1.386	937	707	544	552,34	1.441	1.083	830	1.051,08

Precios para color blanco estándar RAL 9016.

Precios para carta de colores Zehnder +25%. Otros colores, consultar.



# Zehnder Kleo

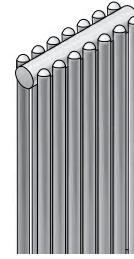
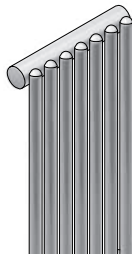
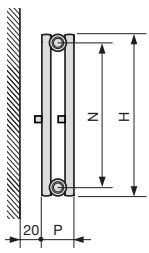

MODELO	KLV 060	KLVD 060
Altura H	600 mm	600 mm
Entre ejes N	562 mm	562 mm
Profundidad P	55 mm	72 mm
Exponente n	1,26	1,28

Recuerde pedir el Pack de Conexión

Longitud L		Emisión EN 442 75/65/20 ΔT 50K W	Emisión Caldera condens. ΔT 40K W	Emisión Bomba de calor ΔT 32,5K W	Blanco RAL 9016 PVP €	Emisión EN 442 75/65/20 ΔT 50K W	Emisión Caldera condens. ΔT 40K W	Emisión Bomba de calor ΔT 32,5K W	Blanco RAL 9016 PVP €
Elementos	mm								
7	231	183	138	106	226,52	283	213	163	398,26
8	264	209	158	121	236,50	323	243	186	418,22
9	297	235	177	137	246,48	364	273	209	438,18
10	330	261	197	152	256,46	404	304	233	458,14
11	363	287	217	167	266,44	444	334	256	478,10
12	396	313	236	182	276,42	485	364	279	498,06
13	429	339	256	197	286,40	525	395	303	518,02
14	462	365	276	212	296,38	566	425	326	537,98
15	495	392	296	228	306,36	606	455	349	557,94
16	528	418	315	243	316,34	646	486	372	577,90
17	561	444	335	258	326,32	687	516	396	597,86
18	594	470	355	273	336,30	727	547	419	617,82
19	627	496	374	288	346,28	768	577	442	637,78
20	660	522	394	303	356,26	808	607	466	657,74
21	693	548	414	319	366,24	848	638	489	677,70
22	726	574	433	334	376,22	889	668	512	697,66
23	759	600	453	349	386,20	929	698	535	717,62
24	792	626	473	364	396,18	970	729	559	737,58
25	825	653	493	379	406,16	1.010	759	582	757,54
26	858	679	512	394	416,14	1.050	789	605	777,50
27	891	705	532	410	426,12	1.091	820	628	797,46
28	924	731	552	425	436,10	1.131	850	652	817,42
29	957	757	571	440	446,08	1.172	881	675	837,38
30	990	783	591	455	456,06	1.212	911	698	857,34
31	1.023	809	611	470	466,04	1.252	941	722	877,30
32	1.056	835	630	485	476,02	1.293	972	745	897,26
33	1.089	861	650	501	486,00	1.333	1.002	768	917,22
34	1.122	887	670	516	495,98	1.374	1.032	791	937,18
35	1.155	914	690	531	505,96	1.414	1.063	815	957,14
36	1.188	940	709	546	515,94	1.454	1.093	838	977,10
37	1.221	966	729	561	525,92	1.495	1.123	861	997,06
38	1.254	992	749	576	535,90	1.535	1.154	884	1.017,02
39	1.287	1.018	768	592	545,88	1.576	1.184	908	1.036,98
40	1.320	1.044	788	607	555,86	1.616	1.214	931	1.056,94
41	1.353	1.070	808	622	565,84	1.656	1.245	954	1.076,90
42	1.386	1.096	828	637	575,82	1.697	1.275	978	1.096,86

Precios para color blanco estándar RAL 9016.  
Precios para carta de colores Zehnder +25%. Otros colores, consultar.



# Zehnder Kleo

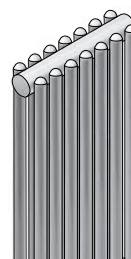
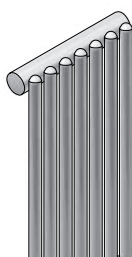
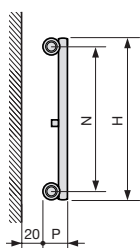

MODELO	KLV 070	KLVD 070
Altura H	700 mm	700 mm
Entre ejes N	662 mm	662 mm
Profundidad P	55 mm	72 mm
Exponente n	1,26	1,28

Recuerde pedir el Pack de Conexión

Elementos	Longitud L		Emisión EN 442 75/65/20 ΔT 50K W	Emisión Caldera condens. ΔT 40K W	Emisión Bomba de calor ΔT 32,5K W	Blanco RAL 9016 PVP €	Emisión EN 442 75/65/20 ΔT 50K W	Emisión Caldera condens. ΔT 40K W	Emisión Bomba de calor ΔT 32,5K W	Blanco RAL 9016 PVP €
	mm									
7	231		209	158	122	234,08	325	244	187	413,39
8	264		239	181	139	245,13	371	279	214	435,51
9	297		269	203	156	256,18	418	314	241	457,63
10	330		299	226	174	267,23	464	349	267	479,75
11	363		329	248	191	278,28	510	384	294	501,87
12	396		359	271	209	289,33	557	418	321	523,99
13	429		389	293	226	300,38	603	453	348	546,11
14	462		419	316	243	311,43	650	488	374	568,23
15	495		449	339	261	322,48	696	523	401	590,35
16	528		478	361	278	333,53	742	558	428	612,47
17	561		508	384	295	344,58	789	593	454	634,59
18	594		538	406	313	355,63	835	628	481	656,71
19	627		568	429	330	366,68	882	663	508	678,83
20	660		598	451	348	377,73	928	697	535	700,95
21	693		628	474	365	388,78	974	732	561	723,07
22	726		658	497	382	399,83	1.021	767	588	745,19
23	759		688	519	400	410,88	1.067	802	615	767,31
24	792		718	542	417	421,93	1.114	837	642	789,43
25	825		748	564	434	432,98	1.160	872	668	811,55
26	858		777	587	452	444,03	1.206	907	695	833,67
27	891		807	609	469	455,08	1.253	942	722	855,79
28	924		837	632	487	466,13	1.299	976	749	877,91
29	957		867	655	504	477,18	1.346	1.011	775	900,03
30	990		897	677	521	488,23	1.392	1.046	802	922,15
31	1.023		927	700	539	499,28	1.438	1.081	829	944,27
32	1.056		957	722	556	510,33	1.485	1.116	855	966,39
33	1.089		987	745	573	521,38	1.531	1.151	882	988,51
34	1.122		1.017	767	591	532,43	1.578	1.186	909	1.010,63
35	1.155		1.047	790	608	543,48	1.624	1.221	936	1.032,75
36	1.188		1.076	813	626	554,53	1.670	1.255	962	1.054,87
37	1.221		1.106	835	643	565,58	1.717	1.290	989	1.076,99
38	1.254		1.136	858	660	576,63	1.763	1.325	1.016	1.099,11
39	1.287		1.166	880	678	587,68	1.810	1.360	1.043	1.121,23
40	1.320		1.196	903	695	598,73	1.856	1.395	1.069	1.143,35
41	1.353		1.226	925	712	609,78	1.902	1.430	1.096	1.165,47
42	1.386		1.256	948	730	620,83	1.949	1.465	1.123	1.187,59

Precios para color blanco estándar RAL 9016.

Precios para carta de colores Zehnder +25%. Otros colores, consultar.



# Zehnder Kleo

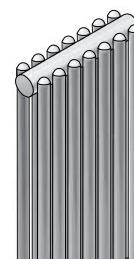
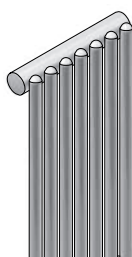
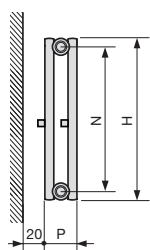

MODELO	KLV 080	KLVD 080
Altura H	800 mm	800 mm
Entre ejes N	762 mm	762 mm
Profundidad P	55 mm	72 mm
Exponente n	1,27	1,28

Recuerde pedir el Pack de Conexión

Longitud L		Emisión EN 442 75/65/20 ΔT 50K W	Emisión Caldera condens. ΔT 40K W	Emisión Bomba de calor ΔT 32,5K W	Blanco RAL 9016 PVP €	Emisión EN 442 75/65/20 ΔT 50K W	Emisión Caldera condens. ΔT 40K W	Emisión Bomba de calor ΔT 32,5K W	Blanco RAL 9016 PVP €
Elementos	mm								
7	231	236	178	136	239,81	366	275	211	424,58
8	264	270	203	156	251,69	418	314	241	448,30
9	297	303	228	175	263,57	471	354	271	472,02
10	330	337	254	195	275,45	523	393	301	495,74
11	363	371	279	214	287,33	575	432	331	519,46
12	396	404	305	234	299,21	628	472	362	543,18
13	429	438	330	253	311,09	680	511	392	566,90
14	462	472	355	273	322,97	732	550	422	590,62
15	495	506	381	292	334,85	785	590	452	614,34
16	528	539	406	312	346,73	837	629	482	638,06
17	561	573	432	331	358,61	889	668	512	661,78
18	594	607	457	351	370,49	941	708	542	685,50
19	627	640	482	370	382,37	994	747	573	709,22
20	660	674	508	390	394,25	1.046	786	603	732,94
21	693	708	533	409	406,13	1.098	825	633	756,66
22	726	741	558	429	418,01	1.151	865	663	780,38
23	759	775	584	448	429,89	1.203	904	693	804,10
24	792	809	609	468	441,77	1.255	943	723	827,82
25	825	843	635	487	453,65	1.308	983	753	851,54
26	858	876	660	507	465,53	1.360	1.022	783	875,26
27	891	910	685	526	477,41	1.412	1.061	814	898,98
28	924	944	711	546	489,29	1.464	1.101	844	922,70
29	957	977	736	565	501,17	1.517	1.140	874	946,42
30	990	1.011	762	585	513,05	1.569	1.179	904	970,14
31	1.023	1.045	787	604	524,93	1.621	1.218	934	993,86
32	1.056	1.078	812	624	536,81	1.674	1.258	964	1.017,58
33	1.089	1.112	838	643	548,69	1.726	1.297	994	1.041,30
34	1.122	1.146	863	663	560,57	1.778	1.336	1.024	1.065,02
35	1.155	1.180	888	682	572,45	1.831	1.376	1.055	1.088,74
36	1.188	1.213	914	702	584,33	1.883	1.415	1.085	1.112,46
37	1.221	1.247	939	721	596,21	1.935	1.454	1.115	1.136,18
38	1.254	1.281	965	741	608,09	1.987	1.494	1.145	1.159,90
39	1.287	1.314	990	760	619,97	2.040	1.533	1.175	1.183,62
40	1.320	1.348	1.015	780	631,85	2.092	1.572	1.205	1.207,34
41	1.353	1.382	1.041	799	643,73	2.144	1.612	1.235	1.231,06
42	1.386	1.415	1.066	819	655,61	2.197	1.651	1.266	1.254,78

Precios para color blanco estándar RAL 9016.

Precios para carta de colores Zehnder +25%. Otros colores, consultar.



# Zehnder Kleo

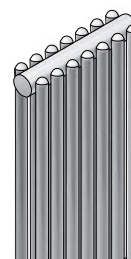
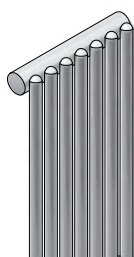
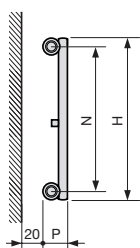

MODELO	KLV 090	KLVD 090
Altura H	900 mm	900 mm
Entre ejes N	862 mm	862 mm
Profundidad P	55 mm	72 mm
Exponente n	1,27	1,28

Recuerde pedir el Pack de Conexión

Elementos	Longitud L mm	Emisión EN 442 75/65/20 ΔT 50K W	Emisión Caldera condens. ΔT 40K W	Emisión Bomba de calor ΔT 32,5K W	Blanco RAL 9016 PVP €	Emisión EN 442 75/65/20 ΔT 50K W	Emisión Caldera condens. ΔT 40K W	Emisión Bomba de calor ΔT 32,5K W	Blanco RAL 9016 PVP €
7	231	262	197	151	249,07	407	306	234	443,63
8	264	299	225	173	262,27	465	349	268	470,07
9	297	337	254	195	275,47	523	393	301	496,51
10	330	374	282	216	288,67	581	437	335	522,95
11	363	411	310	238	301,87	639	480	368	549,39
12	396	449	338	260	315,07	697	524	402	575,83
13	429	486	366	281	328,27	755	568	435	602,27
14	462	524	394	303	341,47	813	611	469	628,71
15	495	561	423	325	354,67	872	655	502	655,15
16	528	598	451	346	367,87	930	699	536	681,59
17	561	636	479	368	381,07	988	742	569	708,03
18	594	673	507	390	394,27	1.046	786	603	734,47
19	627	711	535	411	407,47	1.104	830	636	760,91
20	660	748	563	433	420,67	1.162	873	669	787,35
21	693	785	592	454	433,87	1.220	917	703	813,79
22	726	823	620	476	447,07	1.278	961	736	840,23
23	759	860	648	498	460,27	1.336	1.004	770	866,67
24	792	898	676	519	473,47	1.394	1.048	803	893,11
25	825	935	704	541	486,67	1.453	1.092	837	919,55
26	858	972	732	563	499,87	1.511	1.135	870	945,99
27	891	1.010	761	584	513,07	1.569	1.179	904	972,43
28	924	1.047	789	606	526,27	1.627	1.223	937	998,87
29	957	1.085	817	628	539,47	1.685	1.266	971	1.025,31
30	990	1.122	845	649	552,67	1.743	1.310	1.004	1.051,75
31	1.023	1.159	873	671	565,87	1.801	1.354	1.038	1.078,19
32	1.056	1.197	901	693	579,07	1.859	1.397	1.071	1.104,63
33	1.089	1.234	930	714	592,27	1.917	1.441	1.105	1.131,07
34	1.122	1.272	958	736	605,47	1.975	1.485	1.138	1.157,51
35	1.155	1.309	986	757	618,67	2.034	1.528	1.172	1.183,95
36	1.188	1.346	1.014	779	631,87	2.092	1.572	1.205	1.210,39
37	1.221	1.384	1.042	801	645,07	2.150	1.616	1.239	1.236,83
38	1.254	1.421	1.070	822	658,27	2.208	1.659	1.272	1.263,27
39	1.287	1.459	1.099	844	671,47	2.266	1.703	1.305	1.289,71
40	1.320	1.496	1.127	866	684,67	2.324	1.747	1.339	1.316,15
41	1.353	1.533	1.155	887	697,87	2.382	1.790	1.372	1.342,59
42	1.386	1.571	1.183	909	711,07	2.440	1.834	1.406	1.369,03

Precios para color blanco estándar RAL 9016.

Precios para carta de colores Zehnder +25%. Otros colores, consultar.



# Zehnder Kleo

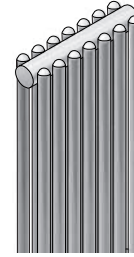
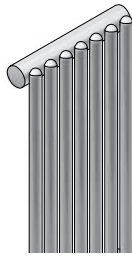
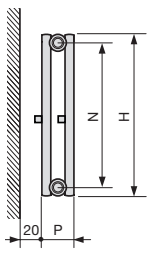

MODELO	KLV 100	KLVD 100
Altura H	1.000 mm	1.000 mm
Entre ejes N	962 mm	962 mm
Profundidad P	55 mm	72 mm
Exponente n	1,27	1,27

Recuerde pedir el Pack de Conexión

Longitud L		Emisión EN 442 75/65/20 ΔT 50K W	Emisión Caldera condens. ΔT 40K W	Emisión Bomba de calor ΔT 32,5K W	Blanco RAL 9016 PVP €	Emisión EN 442 75/65/20 ΔT 50K W	Emisión Caldera condens. ΔT 40K W	Emisión Bomba de calor ΔT 32,5K W	Blanco RAL 9016 PVP €
Elementos	mm								
7	231	288	217	166	254,81	447	336	258	454,92
8	264	329	248	190	268,83	510	384	295	482,97
9	297	370	279	214	282,85	574	433	332	511,02
10	330	411	310	238	296,87	638	481	369	539,07
11	363	452	341	262	310,89	702	529	406	567,12
12	396	493	371	285	324,91	766	577	443	595,17
13	429	534	402	309	338,93	829	625	480	623,22
14	462	575	433	333	352,95	893	673	517	651,27
15	495	617	464	357	366,97	957	721	554	679,32
16	528	658	495	381	380,99	1.021	769	591	707,37
17	561	699	526	404	395,01	1.085	817	628	735,42
18	594	740	557	428	409,03	1.148	865	664	763,47
19	627	781	588	452	423,05	1.212	913	701	791,52
20	660	822	619	476	437,07	1.276	961	738	819,57
21	693	863	650	499	451,09	1.340	1.009	775	847,62
22	726	904	681	523	465,11	1.404	1.057	812	875,67
23	759	945	712	547	479,13	1.467	1.105	849	903,72
24	792	986	743	571	493,15	1.531	1.153	886	931,77
25	825	1.028	774	595	507,17	1.595	1.201	923	959,82
26	858	1.069	805	618	521,19	1.659	1.249	960	987,87
27	891	1.110	836	642	535,21	1.723	1.298	997	1.015,92
28	924	1.151	867	666	549,23	1.786	1.346	1.034	1.043,97
29	957	1.192	898	690	563,25	1.850	1.394	1.071	1.072,02
30	990	1.233	929	713	577,27	1.914	1.442	1.107	1.100,07
31	1.023	1.274	960	737	591,29	1.978	1.490	1.144	1.128,12
32	1.056	1.315	991	761	605,31	2.042	1.538	1.181	1.156,17
33	1.089	1.356	1.022	785	619,33	2.105	1.586	1.218	1.184,22
34	1.122	1.397	1.053	809	633,35	2.169	1.634	1.255	1.212,27
35	1.155	1.439	1.084	832	647,37	2.233	1.682	1.292	1.240,32
36	1.188	1.480	1.114	856	661,39	2.297	1.730	1.329	1.268,37
37	1.221	1.521	1.145	880	675,41	2.361	1.778	1.366	1.296,42
38	1.254	1.562	1.176	904	689,43	2.424	1.826	1.403	1.324,47
39	1.287	1.603	1.207	927	703,45	2.488	1.874	1.440	1.352,52
40	1.320	1.644	1.238	951	717,47	2.552	1.922	1.477	1.380,57
41	1.353	1.685	1.269	975	731,49	2.616	1.970	1.514	1.408,62
42	1.386	1.726	1.300	999	745,51	2.680	2.018	1.550	1.436,67

Precios para color blanco estándar RAL 9016.  
Precios para carta de colores Zehnder +25%. Otros colores, consultar.



# Zehnder Kleo

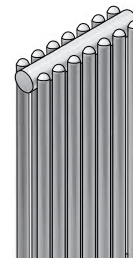
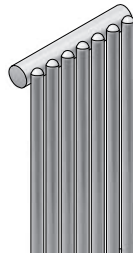
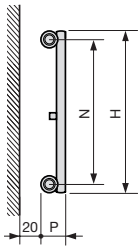

MODELO	KLV 120	KLVD 120
Altura H	1.200 mm	1.200 mm
Entre ejes N	1.162 mm	1.162 mm
Profundidad P	55 mm	72 mm
Exponente n	1,27	1,27

Recuerde pedir el Pack de Conexión

Elementos	Longitud L mm	Emisión EN 442 75/65/20 ΔT 50K	Emisión Caldera condens. ΔT 40K	Emisión Bomba de calor ΔT 32,5K	Blanco RAL 9016	Emisión EN 442 75/65/20 ΔT 50K	Emisión Caldera condens. ΔT 40K	Emisión Bomba de calor ΔT 32,5K	Blanco RAL 9016
		W	W	W	PVP €	W	W	W	PVP €
7	231	340	256	196	271,72	524	395	303	488,77
8	264	388	292	225	288,16	599	451	347	521,66
9	297	437	329	253	304,60	674	508	390	554,55
10	330	485	365	281	321,04	749	564	433	587,44
11	363	534	402	309	337,48	824	621	477	620,33
12	396	582	438	337	353,92	899	677	520	653,22
13	429	631	475	365	370,36	974	733	563	686,11
14	462	679	511	393	386,80	1.049	790	607	719,00
15	495	728	548	421	403,24	1.124	846	650	751,89
16	528	776	585	449	419,68	1.198	903	693	784,78
17	561	825	621	477	436,12	1.273	959	737	817,67
18	594	873	658	505	452,56	1.348	1.015	780	850,56
19	627	922	694	533	469,00	1.423	1.072	823	883,45
20	660	970	731	561	485,44	1.498	1.128	867	916,34
21	693	1.019	767	589	501,88	1.573	1.185	910	949,23
22	726	1.067	804	617	518,32	1.648	1.241	953	982,12
23	759	1.116	840	645	534,76	1.723	1.298	997	1.015,01
24	792	1.164	877	674	551,20	1.798	1.354	1.040	1.047,90
25	825	1.213	913	702	567,64	1.873	1.410	1.083	1.080,79
26	858	1.261	950	730	584,08	1.947	1.467	1.127	1.113,68
27	891	1.310	986	758	600,52	2.022	1.523	1.170	1.146,57
28	924	1.358	1.023	786	616,96	2.097	1.580	1.214	1.179,46
29	957	1.407	1.059	814	633,40	2.172	1.636	1.257	1.212,35
30	990	1.455	1.096	842	649,84	2.247	1.692	1.300	1.245,24
31	1.023	1.504	1.132	870	666,28	2.322	1.749	1.344	1.278,13
32	1.056	1.552	1.169	898	682,72	2.397	1.805	1.387	1.311,02
33	1.089	1.601	1.206	926	699,16	2.472	1.862	1.430	1.343,91
34	1.122	1.649	1.242	954	715,60	2.547	1.918	1.474	1.376,80
35	1.155	1.698	1.279	982	732,04	2.622	1.975	1.517	1.409,69
36	1.188	1.746	1.315	1.010	748,48	2.696	2.031	1.560	1.442,58
37	1.221	1.795	1.352	1.038	764,92	2.771	2.087	1.604	1.475,47
38	1.254	1.843	1.388	1.066	781,36	2.846	2.144	1.647	1.508,36
39	1.287	1.892	1.425	1.094	797,80	2.921	2.200	1.690	1.541,25
40	1.320	1.940	1.461	1.123	814,24	2.996	2.257	1.734	1.574,14
41	1.353	1.989	1.498	1.151	830,68	3.071	2.313	1.777	1.607,03
42	1.386	2.037	1.534	1.179	847,12	3.146	2.369	1.820	1.639,92

Precios para color blanco estándar RAL 9016.

Precios para carta de colores Zehnder +25%. Otros colores, consultar.



# Zehnder Kleo

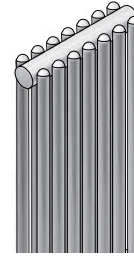
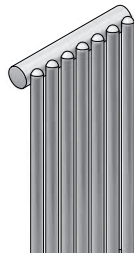
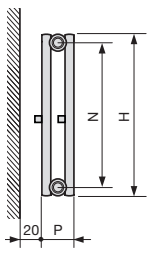

MODELO	KLV 150	KLVD 150
Altura H	1.500 mm	1.500 mm
Entre ejes N	1.462 mm	1.462 mm
Profundidad P	55 mm	72 mm
Exponente n	1,27	1,27

Recuerde pedir el Pack de Conexión

Elementos	Longitud L mm	Emisión EN 442 75/65/20 ΔT 50K	Emisión Caldera condens. ΔT 40K	Emisión Bomba de calor ΔT 32,5K	Blanco RAL 9016	Emisión EN 442 75/65/20 ΔT 50K	Emisión Caldera condens. ΔT 40K	Emisión Bomba de calor ΔT 32,5K	Blanco RAL 9016
		W	W	W	PVP €	W	W	W	PVP €
7	231	416	313	241	292,52	637	480	369	530,52
8	264	475	358	275	311,93	728	548	421	569,37
9	297	535	403	309	331,34	819	617	474	608,22
10	330	594	447	344	350,75	910	685	527	647,07
11	363	653	492	378	370,16	1.001	754	579	685,92
12	396	713	537	412	389,57	1.092	823	632	724,77
13	429	772	582	447	408,98	1.183	891	685	763,62
14	462	832	626	481	428,39	1.274	960	737	802,47
15	495	891	671	516	447,80	1.365	1.028	790	841,32
16	528	950	716	550	467,21	1.456	1.097	842	880,17
17	561	1.010	761	584	486,62	1.547	1.165	895	919,02
18	594	1.069	805	619	506,03	1.638	1.234	948	957,87
19	627	1.129	850	653	525,44	1.729	1.302	1.000	996,72
20	660	1.188	895	687	544,85	1.820	1.371	1.053	1.035,57
21	693	1.247	940	722	564,26	1.911	1.439	1.106	1.074,42
22	726	1.307	984	756	583,67	2.002	1.508	1.158	1.113,27
23	759	1.366	1.029	791	603,08	2.093	1.576	1.211	1.152,12
24	792	1.426	1.074	825	622,49	2.184	1.645	1.264	1.190,97
25	825	1.485	1.119	859	641,90	2.275	1.714	1.316	1.229,82
26	858	1.544	1.163	894	661,31	2.366	1.782	1.369	1.268,67
27	891	1.604	1.208	928	680,72	2.457	1.851	1.422	1.307,52
28	924	1.663	1.253	962	700,13	2.548	1.919	1.474	1.346,37
29	957	1.723	1.298	997	719,54	2.639	1.988	1.527	1.385,22
30	990	1.782	1.342	1.031	738,95	2.730	2.056	1.580	1.424,07
31	1.023	1.841	1.387	1.065	758,36	2.821	2.125	1.632	1.462,92
32	1.056	1.901	1.432	1.100	777,77	2.912	2.193	1.685	1.501,77
33	1.089	1.960	1.476	1.134	797,18	3.003	2.262	1.738	1.540,62
34	1.122	2.020	1.521	1.169	816,59	3.094	2.330	1.790	1.579,47
35	1.155	2.079	1.566	1.203	836,00	3.185	2.399	1.843	1.618,32
36	1.188	2.138	1.611	1.237	855,41	3.276	2.468	1.896	1.657,17
37	1.221	2.198	1.655	1.272	874,82	3.367	2.536	1.948	1.696,02
38	1.254	2.257	1.700	1.306	894,23	3.458	2.605	2.001	1.734,87
39	1.287	2.317	1.745	1.340	913,64	3.549	2.673	2.054	1.773,72
40	1.320	2.376	1.790	1.375	933,05	3.640	2.742	2.106	1.812,57
41	1.353	2.435	1.834	1.409	952,46	3.731	2.810	2.159	1.851,42
42	1.386	2.495	1.879	1.444	971,87	3.822	2.879	2.212	1.890,27

Precios para color blanco estándar RAL 9016.  
Precios para carta de colores Zehnder +25%. Otros colores, consultar.





# Zehnder Kleo

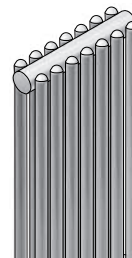
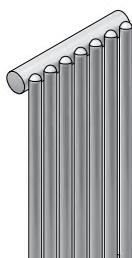
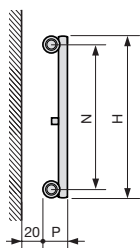

MODELO	KLV 180	KLVD 180
Altura H	1.800 mm	1.800 mm
Entre ejes N	1.762 mm	1.762 mm
Profundidad P	55 mm	72 mm
Exponente n	1,28	1,27

Recuerde pedir el Pack de Conexión

Elementos	Longitud L mm	Emisión EN 442 75/65/20 ΔT 50K W	Emisión Caldera condens. ΔT 40K W	Emisión Bomba de calor ΔT 32,5K W	Blanco RAL 9016 PVP €	Emisión EN 442 75/65/20 ΔT 50K W	Emisión Caldera condens. ΔT 40K W	Emisión Bomba de calor ΔT 32,5K W	Blanco RAL 9016 PVP €
7	231	491	369	283	276,44	742	559	429	535,09
8	264	562	422	324	298,81	848	639	491	579,85
9	297	632	475	364	321,18	954	719	552	624,61
10	330	702	528	404	343,55	1.060	798	613	669,37
11	363	772	580	445	365,92	1.166	878	675	714,13
12	396	842	633	485	388,29	1.272	958	736	758,89
13	429	913	686	526	410,66	1.378	1.038	797	803,65
14	462	983	739	566	433,03	1.484	1.118	859	848,41
15	495	1.053	791	607	455,40	1.590	1.198	920	893,17
16	528	1.123	844	647	477,77	1.696	1.277	981	937,93
17	561	1.193	897	688	500,14	1.802	1.357	1.043	982,69
18	594	1.264	950	728	522,51	1.908	1.437	1.104	1.027,45
19	627	1.334	1.002	768	544,88	2.014	1.517	1.165	1.072,21
20	660	1.404	1.055	809	567,25	2.120	1.597	1.227	1.116,97
21	693	1.474	1.108	849	589,62	2.226	1.677	1.288	1.161,73
22	726	1.544	1.161	890	611,99	2.332	1.757	1.349	1.206,49
23	759	1.615	1.213	930	634,36	2.438	1.836	1.411	1.251,25
24	792	1.685	1.266	971	656,73	2.544	1.916	1.472	1.296,01
25	825	1.755	1.319	1.011	679,10	2.650	1.996	1.533	1.340,77
26	858	1.825	1.372	1.052	701,47	2.756	2.076	1.595	1.385,53
27	891	1.895	1.424	1.092	723,84	2.862	2.156	1.656	1.430,29
28	924	1.966	1.477	1.132	746,21	2.968	2.236	1.717	1.475,05
29	957	2.036	1.530	1.173	768,58	3.074	2.315	1.779	1.519,81
30	990	2.106	1.583	1.213	790,95	3.180	2.395	1.840	1.564,57
31	1.023	2.176	1.636	1.254	813,32	3.286	2.475	1.901	1.609,33
32	1.056	2.246	1.688	1.294	835,69	3.392	2.555	1.963	1.654,09
33	1.089	2.317	1.741	1.335	858,06	3.498	2.635	2.024	1.698,85
34	1.122	2.387	1.794	1.375	880,43	3.604	2.715	2.085	1.743,61
35	1.155	2.457	1.847	1.416	902,80	3.710	2.794	2.147	1.788,37
36	1.188	2.527	1.899	1.456	925,17	3.816	2.874	2.208	1.833,13
37	1.221	2.597	1.952	1.496	947,54	3.922	2.954	2.269	1.877,89
38	1.254	2.668	2.005	1.537	969,91	4.028	3.034	2.331	1.922,65
39	1.287	2.738	2.058	1.577	992,28	4.134	3.114	2.392	1.967,41
40	1.320	2.808	2.110	1.618	1.014,65	4.240	3.194	2.453	2.012,17
41	1.353	2.878	2.163	1.658	1.037,02	4.346	3.274	2.515	2.056,93
42	1.386	2.948	2.216	1.699	1.059,39	4.452	3.353	2.576	2.101,69

Precios para color blanco estándar RAL 9016.

Precios para carta de colores Zehnder +25%. Otros colores, consultar.



# Zehnder Kleo

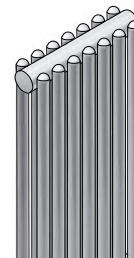
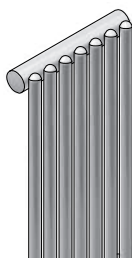
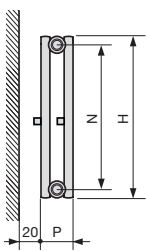

MODELO	KLV 200	KLVD 200
Altura H	2.000 mm	2.000 mm
Entre ejes N	1.962 mm	1.962 mm
Profundidad P	55 mm	72 mm
Exponente n	1,28	1,26

Recuerde pedir el Pack de Conexión

Elementos	Longitud L mm	Emisión EN 442 75/65/20 ΔT 50K W	Emisión Caldera condens. ΔT 40K W	Emisión Bomba de calor ΔT 32,5K W	Blanco RAL 9016 PVP €	Emisión EN 442 75/65/20 ΔT 50K W	Emisión Caldera condens. ΔT 40K W	Emisión Bomba de calor ΔT 32,5K W	Blanco RAL 9016 PVP €
7	231	543	408	313	291,57	812	613	472	565,31
8	264	620	466	357	316,10	928	701	539	614,39
9	297	698	524	402	340,63	1.044	788	607	663,47
10	330	775	582	447	365,16	1.160	876	674	712,55
11	363	853	641	491	389,69	1.276	963	742	761,63
12	396	930	699	536	414,22	1.392	1.051	809	810,71
13	429	1.008	757	580	438,75	1.508	1.138	876	859,79
14	462	1.085	815	625	463,28	1.624	1.226	944	908,87
15	495	1.163	874	670	487,81	1.740	1.314	1.011	957,95
16	528	1.240	932	714	512,34	1.856	1.401	1.079	1.007,03
17	561	1.318	990	759	536,87	1.972	1.489	1.146	1.056,11
18	594	1.395	1.048	804	561,40	2.088	1.576	1.213	1.105,19
19	627	1.473	1.107	848	585,93	2.204	1.664	1.281	1.154,27
20	660	1.550	1.165	893	610,46	2.320	1.751	1.348	1.203,35
21	693	1.628	1.223	938	634,99	2.436	1.839	1.416	1.252,43
22	726	1.705	1.281	982	659,52	2.552	1.927	1.483	1.301,51
23	759	1.783	1.340	1.027	684,05	2.668	2.014	1.550	1.350,59
24	792	1.860	1.398	1.072	708,58	2.784	2.102	1.618	1.399,67
25	825	1.938	1.456	1.116	733,11	2.900	2.189	1.685	1.448,75
26	858	2.015	1.514	1.161	757,64	3.016	2.277	1.753	1.497,83
27	891	2.093	1.573	1.206	782,17	3.132	2.364	1.820	1.546,91
28	924	2.170	1.631	1.250	806,70	3.248	2.452	1.887	1.595,99
29	957	2.248	1.689	1.295	831,23	3.364	2.540	1.955	1.645,07
30	990	2.325	1.747	1.340	855,76	3.480	2.627	2.022	1.694,15
31	1.023	2.403	1.806	1.384	880,29	3.596	2.715	2.090	1.743,23
32	1.056	2.480	1.864	1.429	904,82	3.712	2.802	2.157	1.792,31
33	1.089	2.558	1.922	1.473	929,35	3.828	2.890	2.225	1.841,39
34	1.122	2.635	1.980	1.518	953,88	3.944	2.977	2.292	1.890,47
35	1.155	2.713	2.039	1.563	978,41	4.060	3.065	2.359	1.939,55
36	1.188	2.790	2.097	1.607	1.002,94	4.176	3.152	2.427	1.988,63
37	1.221	2.868	2.155	1.652	1.027,47	4.292	3.240	2.494	2.037,71
38	1.254	2.945	2.213	1.697	1.052,00	4.408	3.328	2.562	2.086,79
39	1.287	3.023	2.272	1.741	1.076,53	4.524	3.415	2.629	2.135,87
40	1.320	3.100	2.330	1.786	1.101,06	4.640	3.503	2.696	2.184,95
41	1.353	3.178	2.388	1.831	1.125,59	4.756	3.590	2.764	2.234,03
42	1.386	3.255	2.446	1.875	1.150,12	4.872	3.678	2.831	2.283,11

Precios para color blanco estándar RAL 9016.

Precios para carta de colores Zehnder +25%. Otros colores, consultar.



# Zehnder Kleo

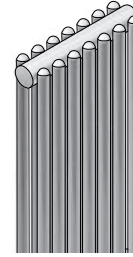
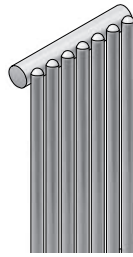
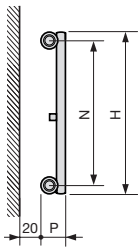

MODELO	KLV 220	KLVD 220
Altura H	2.200 mm	2.200 mm
Entre ejes N	2.162 mm	2.162 mm
Profundidad P	55 mm	72 mm
Exponente n	1,28	1,26

Recuerde pedir el Pack de Conexión

Elementos	Longitud L mm	Emisión EN 442 75/65/20 ΔT 50K W	Emisión Caldera condens. ΔT 40K W	Emisión Bomba de calor ΔT 32,5K W	Blanco RAL 9016 PVP €	Emisión EN 442 75/65/20 ΔT 50K W	Emisión Caldera condens. ΔT 40K W	Emisión Bomba de calor ΔT 32,5K W	Blanco RAL 9016 PVP €
7	231	593	446	342	341,73	882	666	513	628,50
8	264	678	509	390	368,17	1.008	761	586	681,35
9	297	762	573	439	394,61	1.134	856	659	734,20
10	330	847	637	488	421,05	1.260	951	732	787,05
11	363	932	700	537	447,49	1.386	1.046	805	839,90
12	396	1.016	764	586	473,93	1.512	1.141	879	892,75
13	429	1.101	828	634	500,37	1.638	1.237	952	945,60
14	462	1.186	891	683	526,81	1.764	1.332	1.025	998,45
15	495	1.271	955	732	553,25	1.890	1.427	1.098	1.051,30
16	528	1.355	1.018	781	579,69	2.016	1.522	1.172	1.104,15
17	561	1.440	1.082	830	606,13	2.142	1.617	1.245	1.157,00
18	594	1.525	1.146	878	632,57	2.268	1.712	1.318	1.209,85
19	627	1.609	1.209	927	659,01	2.394	1.807	1.391	1.262,70
20	660	1.694	1.273	976	685,45	2.520	1.902	1.464	1.315,55
21	693	1.779	1.337	1.025	711,89	2.646	1.997	1.538	1.368,40
22	726	1.863	1.400	1.074	738,33	2.772	2.093	1.611	1.421,25
23	759	1.948	1.464	1.122	764,77	2.898	2.188	1.684	1.474,10
24	792	2.033	1.528	1.171	791,21	3.024	2.283	1.757	1.526,95
25	825	2.118	1.591	1.220	817,65	3.150	2.378	1.831	1.579,80
26	858	2.202	1.655	1.269	844,09	3.276	2.473	1.904	1.632,65
27	891	2.287	1.719	1.318	870,53	3.402	2.568	1.977	1.685,50
28	924	2.372	1.782	1.366	896,97	3.528	2.663	2.050	1.738,35
29	957	2.456	1.846	1.415	923,41	3.654	2.758	2.123	1.791,20
30	990	2.541	1.910	1.464	949,85	3.780	2.854	2.197	1.844,05
31	1.023	2.626	1.973	1.513	976,29	3.906	2.949	2.270	1.896,90
32	1.056	2.710	2.037	1.562	1.002,73	4.032	3.044	2.343	1.949,75
33	1.089	2.795	2.101	1.610	1.029,17	4.158	3.139	2.416	2.002,60
34	1.122	2.880	2.164	1.659	1.055,61	4.284	3.234	2.490	2.055,45
35	1.155	2.965	2.228	1.708	1.082,05	4.410	3.329	2.563	2.108,30
36	1.188	3.049	2.292	1.757	1.108,49	4.536	3.424	2.636	2.161,15
37	1.221	3.134	2.355	1.806	1.134,93	4.662	3.519	2.709	2.214,00
38	1.254	3.219	2.419	1.854	1.161,37	4.788	3.614	2.782	2.266,85
39	1.287	3.303	2.483	1.903	1.187,81	4.914	3.710	2.856	2.319,70
40	1.320	3.388	2.546	1.952	1.214,25	5.040	3.805	2.929	2.372,55
41	1.353	3.473	2.610	2.001	1.240,69	5.166	3.900	3.002	2.425,40
42	1.386	3.557	2.674	2.050	1.267,13	5.292	3.995	3.075	2.478,25

Precios para color blanco estándar RAL 9016.

Precios para carta de colores Zehnder +25%. Otros colores, consultar.



# Zehnder Kleo

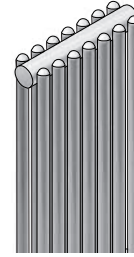
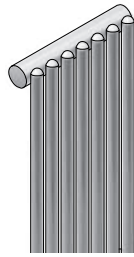
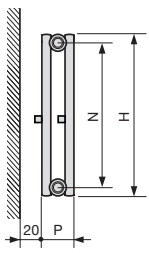

MODELO	KLV 250	KLVD 250
Altura H	2.500 mm	2.500 mm
Entre ejes N	2.462 mm	2.462 mm
Profundidad P	55 mm	72 mm
Exponente n	1,28	1,26

Recuerde pedir el Pack de Conexión

Longitud L		Emisión EN 442 75/65/20 ΔT 50K W	Emisión Caldera condens. ΔT 40K W	Emisión Bomba de calor ΔT 32,5K W	Blanco RAL 9016 PVP €	Emisión EN 442 75/65/20 ΔT 50K W	Emisión Caldera condens. ΔT 40K W	Emisión Bomba de calor ΔT 32,5K W	Blanco RAL 9016 PVP €
Elementos	mm								
7	231	669	503	386	370,08	980	740	570	685,26
8	264	765	575	441	400,57	1.120	845	651	746,22
9	297	860	647	496	431,06	1.260	951	732	807,18
10	330	956	718	551	461,55	1.400	1.057	814	868,14
11	363	1.052	790	606	492,04	1.540	1.163	895	929,10
12	396	1.147	862	661	522,53	1.680	1.268	976	990,06
13	429	1.243	934	716	553,02	1.820	1.374	1.058	1.051,02
14	462	1.338	1.006	771	583,51	1.960	1.480	1.139	1.111,98
15	495	1.434	1.078	826	614,00	2.100	1.585	1.220	1.172,94
16	528	1.530	1.150	881	644,49	2.240	1.691	1.302	1.233,90
17	561	1.625	1.221	936	674,98	2.380	1.797	1.383	1.294,86
18	594	1.721	1.293	991	705,47	2.520	1.902	1.464	1.355,82
19	627	1.816	1.365	1.047	735,96	2.660	2.008	1.546	1.416,78
20	660	1.912	1.437	1.102	766,45	2.800	2.114	1.627	1.477,74
21	693	2.008	1.509	1.157	796,94	2.940	2.219	1.709	1.538,70
22	726	2.103	1.581	1.212	827,43	3.080	2.325	1.790	1.599,66
23	759	2.199	1.652	1.267	857,92	3.220	2.431	1.871	1.660,62
24	792	2.294	1.724	1.322	888,41	3.360	2.536	1.953	1.721,58
25	825	2.390	1.796	1.377	918,90	3.500	2.642	2.034	1.782,54
26	858	2.486	1.868	1.432	949,39	3.640	2.748	2.115	1.843,50
27	891	2.581	1.940	1.487	979,88	3.780	2.854	2.197	1.904,46
28	924	2.677	2.012	1.542	1.010,37	3.920	2.959	2.278	1.965,42
29	957	2.772	2.084	1.597	1.040,86	4.060	3.065	2.359	2.026,38
30	990	2.868	2.155	1.652	1.071,35	4.200	3.171	2.441	2.087,34
31	1.023	2.964	2.227	1.707	1.101,84	4.340	3.276	2.522	2.148,30
32	1.056	3.059	2.299	1.763	1.132,33	4.480	3.382	2.603	2.209,26
33	1.089	3.155	2.371	1.818	1.162,82	4.620	3.488	2.685	2.270,22
34	1.122	3.250	2.443	1.873	1.193,31	4.760	3.593	2.766	2.331,18
35	1.155	3.346	2.515	1.928	1.223,80	4.900	3.699	2.848	2.392,14
36	1.188	3.442	2.587	1.983	1.254,29	5.040	3.805	2.929	2.453,10
37	1.221	3.537	2.658	2.038	1.284,78	5.180	3.910	3.010	2.514,06
38	1.254	3.633	2.730	2.093	1.315,27	5.320	4.016	3.092	2.575,02
39	1.287	3.728	2.802	2.148	1.345,76	5.460	4.122	3.173	2.635,98
40	1.320	3.824	2.874	2.203	1.376,25	5.600	4.227	3.254	2.696,94
41	1.353	3.920	2.946	2.258	1.406,74	5.740	4.333	3.336	2.757,90
42	1.386	4.015	3.018	2.313	1.437,23	5.880	4.439	3.417	2.818,86

Precios para color blanco estándar RAL 9016.  
Precios para carta de colores Zehnder +25%. Otros colores, consultar.



# Zehnder Kleo

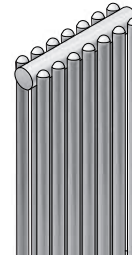
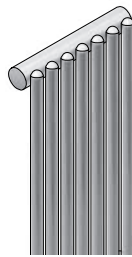
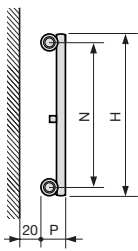

MODELO	KLV 280	KLVD 280
Altura H	2.800 mm	2.800 mm
Entre ejes N	2.762 mm	2.762 mm
Profundidad P	55 mm	72 mm
Exponente n	1,29	1,25

Recuerde pedir el Pack de Conexión

Elementos	Longitud L mm	Emisión EN 442 75/65/20 ΔT 50K	Emisión Caldera condens. ΔT 40K	Emisión Bomba de calor ΔT 32,5K	Blanco RAL 9016	Emisión EN 442 75/65/20 ΔT 50K	Emisión Caldera condens. ΔT 40K	Emisión Bomba de calor ΔT 32,5K	Blanco RAL 9016
		W	W	W	PVP €	W	W	W	PVP €
7	231	749	562	430	401,99	1.071	810	625	749,31
8	264	856	642	491	437,04	1.224	926	714	819,42
9	297	963	722	552	472,09	1.377	1.042	804	889,53
10	330	1.070	802	614	507,14	1.530	1.158	893	959,64
11	363	1.177	883	675	542,19	1.683	1.273	982	1.029,75
12	396	1.284	963	737	577,24	1.836	1.389	1.072	1.099,86
13	429	1.391	1.043	798	612,29	1.989	1.505	1.161	1.169,97
14	462	1.498	1.123	859	647,34	2.142	1.621	1.250	1.240,08
15	495	1.605	1.204	921	682,39	2.295	1.736	1.339	1.310,19
16	528	1.712	1.284	982	717,44	2.448	1.852	1.429	1.380,30
17	561	1.819	1.364	1.043	752,49	2.601	1.968	1.518	1.450,41
18	594	1.926	1.444	1.105	787,54	2.754	2.084	1.607	1.520,52
19	627	2.033	1.524	1.166	822,59	2.907	2.199	1.697	1.590,63
20	660	2.140	1.605	1.228	857,64	3.060	2.315	1.786	1.660,74
21	693	2.247	1.685	1.289	892,69	3.213	2.431	1.875	1.730,85
22	726	2.354	1.765	1.350	927,74	3.366	2.547	1.965	1.800,96
23	759	2.461	1.845	1.412	962,79	3.519	2.662	2.054	1.871,07
24	792	2.568	1.926	1.473	997,84	3.672	2.778	2.143	1.941,18
25	825	2.675	2.006	1.535	1.032,89	3.825	2.894	2.232	2.011,29
26	858	2.782	2.086	1.596	1.067,94	3.978	3.010	2.322	2.081,40
27	891	2.889	2.166	1.657	1.102,99	4.131	3.125	2.411	2.151,51
28	924	2.996	2.247	1.719	1.138,04	4.284	3.241	2.500	2.221,62
29	957	3.103	2.327	1.780	1.173,09	4.437	3.357	2.590	2.291,73
30	990	3.210	2.407	1.841	1.208,14	4.590	3.473	2.679	2.361,84
31	1.023	3.317	2.487	1.903	1.243,19	4.743	3.589	2.768	2.431,95
32	1.056	3.424	2.568	1.964	1.278,24	4.896	3.704	2.857	2.502,06
33	1.089	3.531	2.648	2.026	1.313,29	5.049	3.820	2.947	2.572,17
34	1.122	3.638	2.728	2.087	1.348,34	5.202	3.936	3.036	2.642,28
35	1.155	3.745	2.808	2.148	1.383,39	5.355	4.052	3.125	2.712,39
36	1.188	3.852	2.888	2.210	1.418,44	5.508	4.167	3.215	2.782,50
37	1.221	3.959	2.969	2.271	1.453,49	5.661	4.283	3.304	2.852,61
38	1.254	4.066	3.049	2.333	1.488,54	5.814	4.399	3.393	2.922,72
39	1.287	4.173	3.129	2.394	1.523,59	5.967	4.515	3.483	2.992,83
40	1.320	4.280	3.209	2.455	1.558,64	6.120	4.630	3.572	3.062,94
41	1.353	4.387	3.290	2.517	1.593,69	6.273	4.746	3.661	3.133,05
42	1.386	4.494	3.370	2.578	1.628,74	6.426	4.862	3.750	3.203,16

Precios para color blanco estándar RAL 9016.

Precios para carta de colores Zehnder +25%. Otros colores, consultar.



# Zehnder Kleo

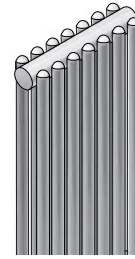
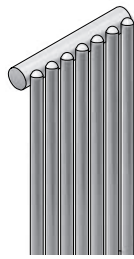
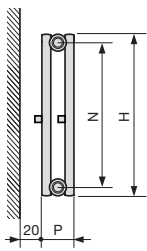

MODELO	KLV 300	KLVD 300
Altura H	3.000 mm	3.000 mm
Entre ejes N	2.962 mm	2.962 mm
Profundidad P	55 mm	72 mm
Exponente n	1,29	1,25

Recuerde pedir el Pack de Conexión

Elementos	Longitud L mm	Emisión EN 442 75/65/20 ΔT 50K	Emisión Caldera condens. ΔT 40K	Emisión Bomba de calor ΔT 32,5K	Blanco RAL 9016	Emisión EN 442 75/65/20 ΔT 50K	Emisión Caldera condens. ΔT 40K	Emisión Bomba de calor ΔT 32,5K	Blanco RAL 9016
		W	W	W	PVP €	W	W	W	PVP €
7	231	798	598	458	420,97	1.134	858	662	787,28
8	264	912	684	523	458,73	1.296	981	756	862,81
9	297	1.026	769	589	496,49	1.458	1.103	851	938,34
10	330	1.140	855	654	534,25	1.620	1.226	945	1.013,87
11	363	1.254	940	719	572,01	1.782	1.348	1.040	1.089,40
12	396	1.368	1.026	785	609,77	1.944	1.471	1.135	1.164,93
13	429	1.482	1.111	850	647,53	2.106	1.593	1.229	1.240,46
14	462	1.596	1.197	916	685,29	2.268	1.716	1.324	1.315,99
15	495	1.710	1.282	981	723,05	2.430	1.839	1.418	1.391,52
16	528	1.824	1.368	1.046	760,81	2.592	1.961	1.513	1.467,05
17	561	1.938	1.453	1.112	798,57	2.754	2.084	1.607	1.542,58
18	594	2.052	1.539	1.177	836,33	2.916	2.206	1.702	1.618,11
19	627	2.166	1.624	1.243	874,09	3.078	2.329	1.796	1.693,64
20	660	2.280	1.710	1.308	911,85	3.240	2.451	1.891	1.769,17
21	693	2.394	1.795	1.373	949,61	3.402	2.574	1.986	1.844,70
22	726	2.508	1.881	1.439	987,37	3.564	2.696	2.080	1.920,23
23	759	2.622	1.966	1.504	1.025,13	3.726	2.819	2.175	1.995,76
24	792	2.736	2.052	1.570	1.062,89	3.888	2.942	2.269	2.071,29
25	825	2.850	2.137	1.635	1.100,65	4.050	3.064	2.364	2.146,82
26	858	2.964	2.223	1.700	1.138,41	4.212	3.187	2.458	2.222,35
27	891	3.078	2.308	1.766	1.176,17	4.374	3.309	2.553	2.297,88
28	924	3.192	2.394	1.831	1.213,93	4.536	3.432	2.647	2.373,41
29	957	3.306	2.479	1.897	1.251,69	4.698	3.554	2.742	2.448,94
30	990	3.420	2.565	1.962	1.289,45	4.860	3.677	2.836	2.524,47
31	1.023	3.534	2.650	2.027	1.327,21	5.022	3.800	2.931	2.600,00
32	1.056	3.648	2.736	2.093	1.364,97	5.184	3.922	3.026	2.675,53
33	1.089	3.762	2.821	2.158	1.402,73	5.346	4.045	3.120	2.751,06
34	1.122	3.876	2.906	2.224	1.440,49	5.508	4.167	3.215	2.826,59
35	1.155	3.990	2.992	2.289	1.478,25	5.670	4.290	3.309	2.902,12
36	1.188	4.104	3.077	2.354	1.516,01	5.832	4.412	3.404	2.977,65
37	1.221	4.218	3.163	2.420	1.553,77	5.994	4.535	3.498	3.053,18
38	1.254	4.332	3.248	2.485	1.591,53	6.156	4.658	3.593	3.128,71
39	1.287	4.446	3.334	2.551	1.629,29	6.318	4.780	3.687	3.204,24
40	1.320	4.560	3.419	2.616	1.667,05	6.480	4.903	3.782	3.279,77
41	1.353	4.674	3.505	2.681	1.704,81	6.642	5.025	3.877	3.355,30
42	1.386	4.788	3.590	2.747	1.742,57	6.804	5.148	3.971	3.430,83

Precios para color blanco estándar RAL 9016.  
Precios para carta de colores Zehnder +25%. Otros colores, consultar.



# Zehnder Kleo

## FIGURAS DE CONEXIÓN

**Conexiones Bitubo normales.** Sin suplemento de precio.

Misma mano



Cruzados

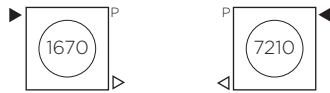

Lados opuestos

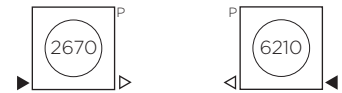

**Conexiones Bitubo especiales.** Con suplemento de precio **58,43 €.**

Desde abajo / hacia abajo



Desde arriba / hacia arriba



**Conexiones Mono-bitubo.** Con suplemento de precio **58,43 €.**

Para válvula Mono-Bitubo de 50 mm (Tipos P o Q).

Instalaciones Bitubo; *bypass* cerrado.

Instalaciones Monotubo; *bypass* abierto.

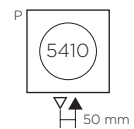
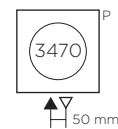
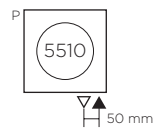
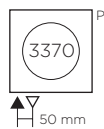

**Conexiones Monotubo.** Con suplemento de precio **58,43 €.**

### Radiadores de tubos verticales

La impulsión (entrada) debe ser por el exterior de la caña.

Válvula Tipo N. (Monotubo horizontal).

Las cañas deben ser lo más largas posibles.

Longitud máxima 26 elementos.

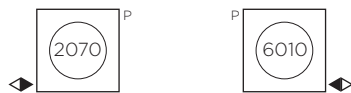

### Radiadores de tubos horizontales

La impulsión (entrada) debe ser por el interior de la caña.

Válvula Tipo K o M. (Monotubo vertical).

Las cañas deben ser lo más largas posibles.

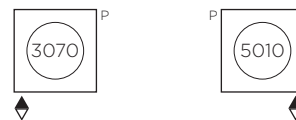

Para Monotubo, también es posible usar una conexión Mono-Bitubo con la válvula tipo P o Q con el *bypass* abierto.

## MEDIDAS DE RACORES

Otras posiciones de racores, por ejemplo desde arriba hacia arriba, hacia atrás o adelante, pueden suministrarse bajo pedido, con suplemento de precio a consultar.

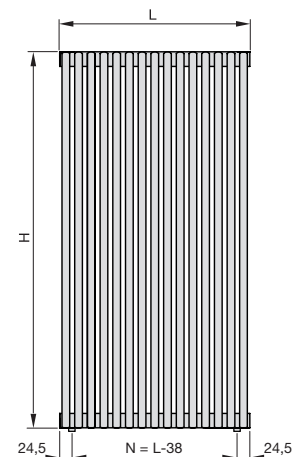
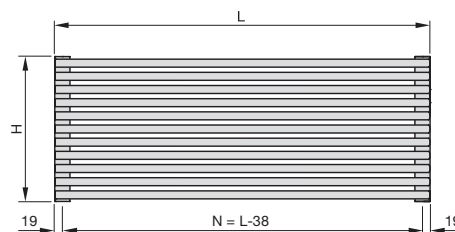

# Zehnder Kleo

## SOPORTES ESTÁNDAR

### Kit de soportes

Soportes a la pared incluidos en el embalaje. En el color del radiador solo con el pedido inicial.

Cada radiador lleva el Kit con su cantidad y tipo necesario de soportes murales. (A la pared).

### Kit de soportes adicional

Al pedir un Kit de soportes adicional hay que indicar para que radiador. Diferentes radiadores usan diferentes kits.

Blanco estándar (RAL 9016)

PVP **54,67 €**



## SOPORTES SOLDADOS

Soldados en fábrica. Solo con el pedido del radiador.

De altura regulable.

Hasta 0,75 m de altura total, incluyendo la distancia del radiador al suelo, es suficiente con soportes inferiores.

A partir de 0,75 m de altura total es necesario prever soportes en la parte superior del radiador.

El número y posición de los soportes se define en función de las medidas del radiador. Consultar.



FC

Dimensiones de la base: 100 x 50 mm.

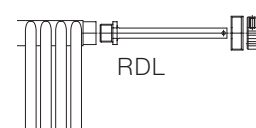

RDL

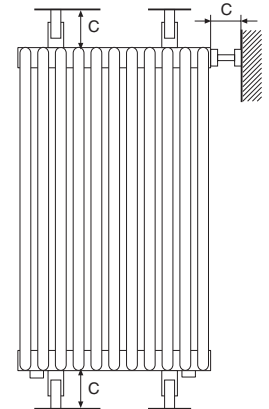
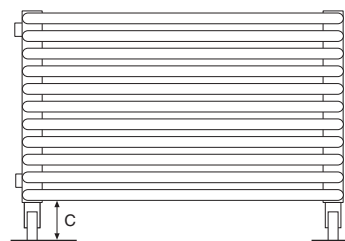

Tipo de soporte	Distancia al suelo/techo/pared		Referencia	PVP
	C mínimo mm	C máximo mm		
<b>Soportes de pie soldados</b>				
Altura regulable	150	200	FC200	<b>101,99</b>
	120	150	FC150	
A medida	A medida		FRCUS	<b>154,43</b>
<b>Soporte lateral atornillado</b>				
Regulable	60	170	RDL/RDR	<b>110,14</b>

Solo con conexiones laterales.



# Zehnder Nova

Un clásico renovado





El radiador a medida más versátil. Zehnder Nova se adapta a todas las necesidades de calor, espacio o estilo gracias a su amplia variedad de modelos y ejecuciones especiales. De diseño elegante y escasa profundidad, ofrece siempre la solución más adecuada. Clásica, contemporánea o vanguardista.



# Zehnder Nova



# Zehnder Nova

## VERSIONES Y ACABADOS

Disponible en versiones verticales y horizontales (ver páginas 206 y 207).

Se suministra en color blanco (RAL 9016).

Disponible en los colores de la carta Zehnder (ver página 10).

Para otros colores o acabados, consultar.

### Ejecuciones especiales:

Radiadores en ángulo: modelos NH, NHL, NV y NVL.

Radiadores curvos: modelos NH.

Longitudes o altura especiales.

Posición de racores especial y figuras de conexión distintas (ver página 236).

Alta presión.

Soportes de pie, de empotrar y soldados a consultar.

Todas las ejecuciones especiales deben ser consultadas para verificar disponibilidad y precio.

## SOPORTES

Soportes de pared incluidos en el embalaje. En el color del radiador solo con el pedido inicial.

Otros soportes de pie, de empotrar, soldados, disponibles bajo pedido.

### Kit de soportes adicional.

Blanco estándar (RAL 9016).

PVP **54,67 €**

## PACK DE CONEXIÓN

Incluye todas las piezas necesarias para la conexión (ver página 257).

### Bitubo. Modelos horizontales:

Para la conexión estándar  
Juego de Válvula + Detentor. Tipo B.



Tipo B

### Monotubo. Modelos horizontales:

Válvula Monotubo Horizontal. Tipo N.

Solo bajo pedido. Necesita que el radiador se fabrique especialmente.

Hay que indicar en el pedido si es derecha o izquierda. (Ver página 236).



Tipo N

### Bitubo y Monotubo. Modelos Verticales:

Válvula Mono-Bitubo de conexión inferior con entre ejes de 50 mm. Instalaciones Bitubo; *bypass* cerrado. Instalaciones Monotubo; *bypass* abierto.

Como estándar se suministra el tipo P (entrada por la derecha). El tipo Q bajo pedido.

La entrada derecha-izquierda no es relevante si la válvula no es termostática.



Tipo P



Tipo Q

Tipo de válvula	Acabado	Regulación manual PVP €	Regulación termostática PVP €
Todos los tipos de válvulas	Todos los acabados	<b>202,59</b>	<b>268,14</b>

# Zehnder Nova

## ESPECIFICACIONES TÉCNICAS

Versión horizontal

Modelos NH

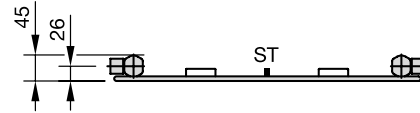
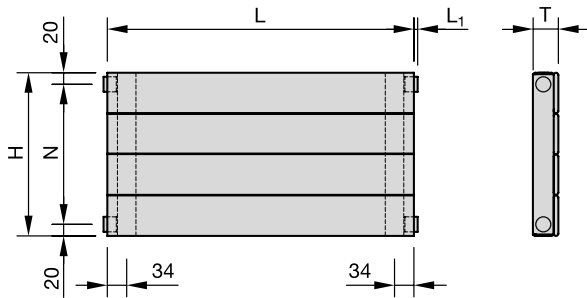

Modelos NHL

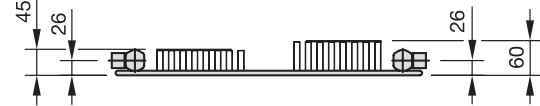
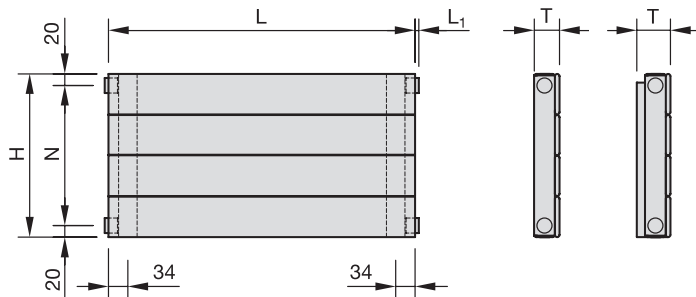

Modelos NHLH

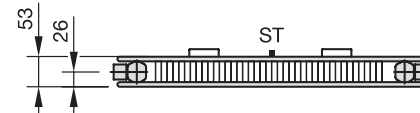
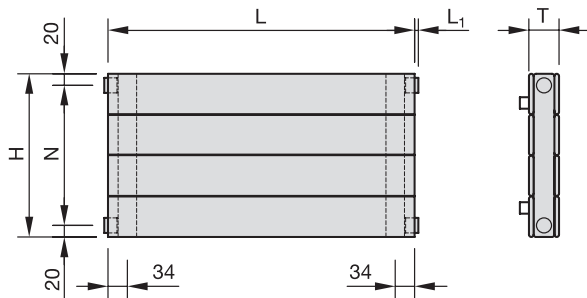

Modelos NHH

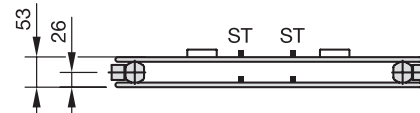
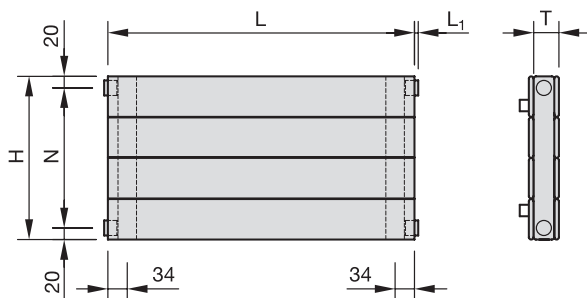

Modelos NLLH

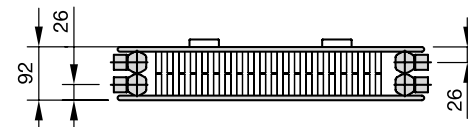
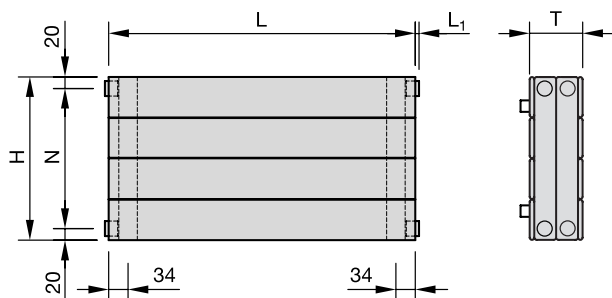

# Zehnder Nova

## ESPECIFICACIONES TÉCNICAS

### Versión vertical

#### Modelos NV

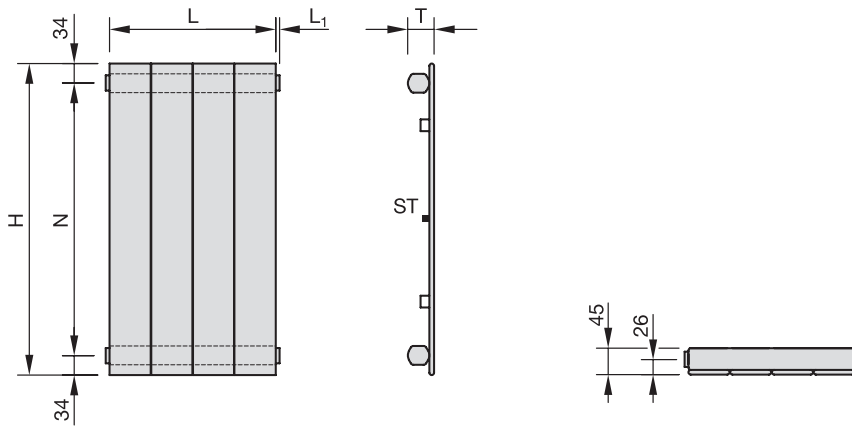

#### Modelos NVL

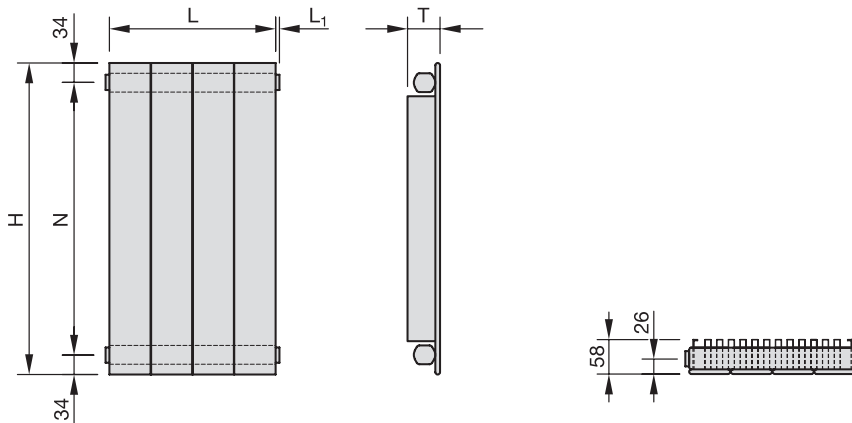

- Tubos ultraplano de acero de 70 x 8 mm. Distancia entre tubos: 1 mm
- Colectores: tubos hexagonales de acero de 37 x 32 mm.
- Aletas de plancha de acero de 0,5 mm para los modelos aleteados.
- Presión máxima de servicio 4,6 bar. Presión de prueba en fábrica 6 bar.

L = Longitud. H = Altura. N = Distancia entre ejes.

# Zehnder Nova

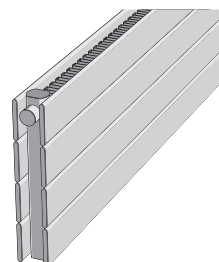
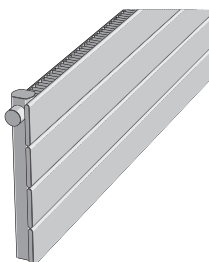
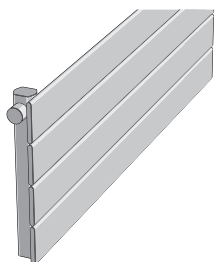
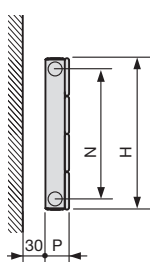

MODELO	NH 14	NHL14/14	NHLH 14/14
Altura H	141 mm	141 mm	141 mm
Entre ejes N	101 mm	101 mm	101 mm
Profundidad P	45 mm	45 mm	53 mm
Exponente n	1,24	1,23	1,25

Recuerde pedir el Pack de Conexión

Longitud L mm	Emisión EN 442 75/65/20 ΔT 50K	Emisión Caldera condens. ΔT 40K	Emisión Bomba de calor ΔT 32,5K	Blanco RAL 9016	Emisión EN 442 75/65/20 ΔT 50K	Emisión Caldera condens. ΔT 40K	Emisión Bomba de calor ΔT 32,5K	Blanco RAL 9016	Emisión EN 442 75/65/20 ΔT 50K	Emisión Caldera condens. ΔT 40K	Emisión Bomba de calor ΔT 32,5K	Blanco RAL 9016
	W	W	W	PVP €	W	W	W	PVP €	W	W	W	PVP €
500	91	69	53	185,27	170	129	100	278,88	221	167	129	395,92
600	109	83	64	191,82	203	155	120	290,01	265	201	155	416,89
700	127	97	75	198,38	237	180	140	301,15	309	234	181	437,86
800	146	110	85	204,93	271	206	160	312,29	354	268	206	458,83
900	164	124	96	211,49	305	232	180	323,42	398	301	232	479,80
1.000	182	138	107	218,04	339	258	200	334,56	442	334	258	500,77
1.100	200	152	117	224,59	373	283	220	345,70	486	368	284	521,74
1.200	218	166	128	231,15	407	309	239	356,83	530	401	310	542,71
1.300	237	179	139	237,70	441	335	259	367,97	575	435	335	563,68
1.400	255	193	149	244,26	475	361	279	379,11	619	468	361	584,65
1.500	273	207	160	250,81	509	386	299	390,25	663	502	387	605,63
1.600	291	221	171	257,36	542	412	319	401,38	707	535	413	626,60
1.700	309	235	181	263,92	576	438	339	412,52	751	569	439	647,57
1.800	328	248	192	270,47	610	464	359	423,66	796	602	464	668,54
1.900	346	262	203	277,03	644	490	379	434,79	840	635	490	689,51
2.000	364	276	213	283,58	678	515	399	445,93	884	669	516	710,48
2.200	400	304	235	296,69	746	567	439	468,20	972	736	568	752,42
2.400	437	331	256	309,80	814	618	479	490,48	1.061	803	619	794,36
2.600	473	359	277	322,90	881	670	519	512,75	1.149	869	671	836,31
2.800	510	386	299	336,01	949	721	559	535,03	1.238	936	722	878,25
3.000	546	414	320	349,12	1.017	773	599	557,30	1.326	1.003	774	920,19
3.200	582	442	341	362,23	1.085	824	639	579,57	1.414	1.070	825	962,13
3.400	619	469	363	375,34	1.153	876	679	601,85	1.503	1.137	877	1.004,07
3.600	655	497	384	388,44	1.220	927	718	624,12	1.591	1.204	929	1.046,02
3.800	692	524	405	401,55	1.288	979	758	646,40	1.680	1.271	980	1.087,96
4.000	728	552	427	414,66	1.356	1.031	798	668,67	1.768	1.338	1.032	1.129,90
4.200	764	580	448	427,77	1.424	1.082	838	690,94	1.856	1.405	1.083	1.171,84
4.400	801	607	469	440,88	1.492	1.134	878	713,22	1.945	1.471	1.135	1.213,78
4.600	837	635	491	453,98	1.559	1.185	918	735,49	2.033	1.538	1.187	1.255,73
4.800	874	662	512	467,09	1.627	1.237	958	757,77	2.122	1.605	1.238	1.297,67
5.000	910	690	533	480,20	1.695	1.288	998	780,04	2.210	1.672	1.290	1.339,61
5.200	946	718	555	493,31	1.763	1.340	1.038	802,31	2.298	1.739	1.341	1.381,55
5.400	983	745	576	506,42	1.831	1.391	1.078	824,59	2.387	1.806	1.393	1.423,49
5.600	1.019	773	597	519,52	1.898	1.443	1.118	846,86	2.475	1.873	1.445	1.465,44
5.800	1.056	800	619	532,63	1.966	1.494	1.157	869,14	2.564	1.940	1.496	1.507,38
6.000	1.092	828	640	545,74	2.034	1.546	1.197	891,41	2.652	2.006	1.548	1.549,32

Precios para color blanco estándar RAL 9016.

Precios para carta de colores Zehnder +25%. Otros colores, consultar.



# Zehnder Nova

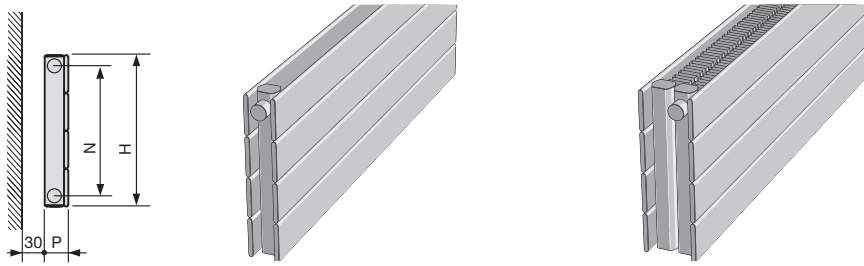

MODELO	NHH 14	NHLH 14/14
Altura H	141 mm	141 mm
Entre ejes N	101 mm	101 mm
Profundidad P	53 mm	92 mm
Exponente n	1,24	1,23

Recuerde pedir el Pack de Conexión

Longitud L mm	Emisión EN 442 75/65/20 ΔT 50K W	Emisión Caldera condens. ΔT 40K W	Emisión Bomba de calor ΔT 32,5K W	Blanco RAL 9016 PVP €	Emisión EN 442 75/65/20 ΔT 50K W	Emisión Caldera condens. ΔT 40K W	Emisión Bomba de calor ΔT 32,5K W	Blanco RAL 9016 PVP €
500	152	115	89	271,18	315	239	185	552,32
600	182	138	107	284,52	378	287	223	575,07
700	212	161	124	297,87	441	335	260	597,82
800	242	184	142	311,21	504	383	297	620,56
900	273	207	160	324,56	567	431	334	643,31
1.000	303	230	178	337,90	630	479	371	666,06
1.100	333	253	195	351,24	693	527	408	688,81
1.200	364	276	213	364,59	756	575	445	711,56
1.300	394	299	231	377,93	819	622	482	734,30
1.400	424	322	249	391,28	882	670	519	757,05
1.500	455	345	266	404,62	945	718	556	779,80
1.600	485	368	284	417,96	1.008	766	593	802,55
1.700	515	391	302	431,31	1.071	814	630	825,30
1.800	545	414	320	444,65	1.134	862	668	848,04
1.900	576	437	337	458,00	1.197	910	705	870,79
2.000	606	460	355	471,34	1.260	958	742	893,54
2.200	667	505	391	498,03	1.386	1.053	816	939,04
2.400	727	551	426	524,72	1.512	1.149	890	984,53
2.600	788	597	462	551,40	1.638	1.245	964	1.030,03
2.800	848	643	497	578,09	1.764	1.341	1.038	1.075,52
3.000	909	689	533	604,78	1.890	1.436	1.113	1.121,02
3.200	970	735	568	631,47	2.016	1.532	1.187	1.166,52
3.400	1.030	781	604	658,16	2.142	1.628	1.261	1.212,01
3.600	1.091	827	639	684,84	2.268	1.724	1.335	1.257,51
3.800	1.151	873	675	711,53	2.394	1.819	1.409	1.303,00
4.000	1.212	919	710	738,22	2.520	1.915	1.483	1.348,50
4.200	1.273	965	746	764,91	2.646	2.011	1.558	1.394,00
4.400	1.333	1.011	781	791,60	2.772	2.107	1.632	1.439,49
4.600	1.394	1.057	817	818,28	2.898	2.202	1.706	1.484,99
4.800	1.454	1.103	853	844,97	3.024	2.298	1.780	1.530,48
5.000	1.515	1.149	888	871,66	3.150	2.394	1.854	1.575,98
5.200	1.576	1.195	924	898,35	3.276	2.490	1.929	1.621,48
5.400	1.636	1.241	959	925,04	3.402	2.585	2.003	1.666,97
5.600	1.697	1.287	995	951,72	3.528	2.681	2.077	1.712,47
5.800	1.757	1.333	1.030	978,41	3.654	2.777	2.151	1.757,96
6.000	1.818	1.379	1.066	1.005,10	3.780	2.873	2.225	1.803,46

Precios para color blanco estándar RAL 9016.

Precios para carta de colores Zehnder +25%. Otros colores, consultar.





# Zehnder Nova

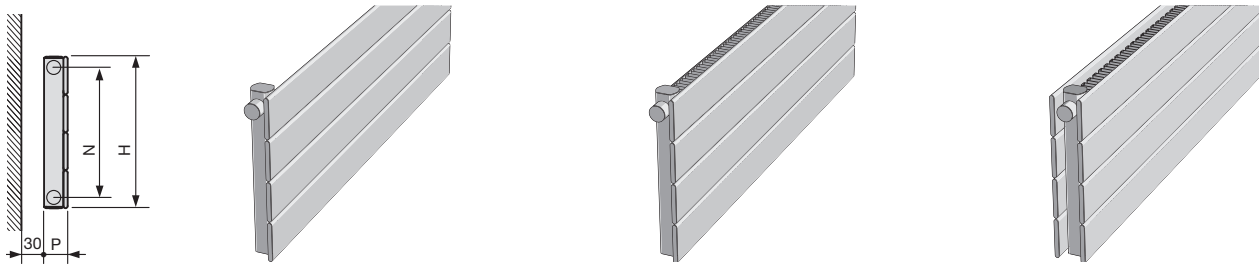

MODELO	NH 21	NHL 21/21	NHLH 21/21
Altura H	212 mm	212 mm	212 mm
Entre ejes N	172 mm	172 mm	172 mm
Profundidad P	45 mm	45 mm	53 mm
Exponente n	1,25	1,25	1,27

Recuerde pedir el Pack de Conexión

Longitud L mm	Emisión EN 442 75/65/20 ΔT 50K W	Emisión Caldera condens. ΔT 40K W	Emisión Bomba de calor ΔT 32,5K W	Blanco RAL 9016 PVP €	Emisión EN 442 75/65/20 ΔT 50K W	Emisión Caldera condens. ΔT 40K W	Emisión Bomba de calor ΔT 32,5K W	Blanco RAL 9016 PVP €	Emisión EN 442 75/65/20 ΔT 50K W	Emisión Caldera condens. ΔT 40K W	Emisión Bomba de calor ΔT 32,5K W	Blanco RAL 9016 PVP €
500	127	96	74	217,21	228	173	133	313,78	298	224	172	471,73
600	152	115	89	226,21	274	207	160	328,15	357	269	207	498,50
700	178	135	104	235,22	319	242	186	342,53	417	314	241	525,28
800	203	154	119	244,23	365	276	213	356,90	476	359	275	552,05
900	229	173	133	253,23	410	311	240	371,28	536	403	310	578,83
1.000	254	192	148	262,24	456	345	266	385,65	595	448	344	605,60
1.100	279	211	163	271,25	502	380	293	400,02	655	493	379	632,38
1.200	305	231	178	280,25	547	414	319	414,40	714	538	413	659,15
1.300	330	250	193	289,26	593	449	346	428,77	774	583	448	685,93
1.400	356	269	208	298,27	638	483	373	443,15	833	627	482	712,70
1.500	381	288	222	307,28	684	518	399	457,52	893	672	516	739,48
1.600	406	307	237	316,28	730	552	426	471,89	952	717	551	766,25
1.700	432	327	252	325,29	775	587	452	486,27	1.012	762	585	793,03
1.800	457	346	267	334,30	821	621	479	500,64	1.071	807	620	819,80
1.900	483	365	282	343,30	866	656	506	515,02	1.131	852	654	846,58
2.000	508	384	296	352,31	912	690	532	529,39	1.190	896	689	873,35
2.200	559	423	326	370,32	1.003	759	586	558,14	1.309	986	757	926,90
2.400	610	461	356	388,34	1.094	828	639	586,89	1.428	1.076	826	980,45
2.600	660	500	385	406,35	1.186	897	692	615,63	1.547	1.165	895	1.034,00
2.800	711	538	415	424,37	1.277	966	745	644,38	1.666	1.255	964	1.087,55
3.000	762	577	445	442,38	1.368	1.035	798	673,13	1.785	1.345	1.033	1.141,10
3.200	813	615	474	460,39	1.459	1.104	852	701,88	1.904	1.434	1.102	1.194,65
3.400	864	653	504	478,41	1.550	1.173	905	730,63	2.023	1.524	1.171	1.248,20
3.600	914	692	534	496,42	1.642	1.242	958	759,37	2.142	1.613	1.239	1.301,75
3.800	965	730	563	514,44	1.733	1.311	1.011	788,12	2.261	1.703	1.308	1.355,30
4.000	1.016	769	593	532,45	1.824	1.380	1.065	816,87	2.380	1.793	1.377	1.408,85
4.200	1.067	807	623	550,46	1.915	1.449	1.118	845,62	2.499	1.882	1.446	1.462,40
4.400	1.118	846	652	568,48	2.006	1.518	1.171	874,37	2.618	1.972	1.515	1.515,95
4.600	1.168	884	682	586,49	2.098	1.587	1.224	903,11	2.737	2.062	1.584	1.569,50
4.800	1.219	922	712	604,51	2.189	1.656	1.277	931,86	2.856	2.151	1.653	1.623,05
5.000	1.270	961	741	622,52	2.280	1.725	1.331	960,61	2.975	2.241	1.721	1.676,60
5.200	1.321	999	771	640,53	2.371	1.794	1.384	989,36	3.094	2.330	1.790	1.730,15
5.400	1.372	1.038	801	658,55	2.462	1.863	1.437	1.018,11	3.213	2.420	1.859	1.783,70
5.600	1.422	1.076	830	676,56	2.554	1.932	1.490	1.046,85	3.332	2.510	1.928	1.837,25
5.800	1.473	1.115	860	694,58	2.645	2.001	1.544	1.075,60	3.451	2.599	1.997	1.890,80
6.000	1.524	1.153	889	712,59	2.736	2.070	1.597	1.104,35	3.570	2.689	2.066	1.944,35

Precios para color blanco estándar RAL 9016.

Precios para carta de colores Zehnder +25%. Otros colores, consultar.



# Zehnder Nova

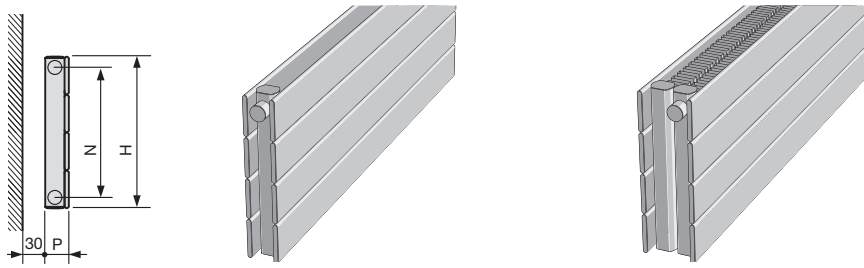

MODELO	NHH 21	NHLLH 21/21
Altura H	212 mm	212 mm
Entre ejes N	172 mm	172 mm
Profundidad P	53 mm	92 mm
Exponente n	1,23	1,25

Recuerde pedir el Pack de Conexión

Longitud L mm	Emisión EN 442 75/65/20 ΔT 50K W	Emisión Caldera condens. ΔT 40K W	Emisión Bomba de calor ΔT 32,5K W	Blanco RAL 9016 PVP €	Emisión EN 442 75/65/20 ΔT 50K W	Emisión Caldera condens. ΔT 40K W	Emisión Bomba de calor ΔT 32,5K W	Blanco RAL 9016 PVP €
500	208	158	122	335,58	429	324	250	625,49
600	249	189	147	353,84	514	389	300	654,93
700	291	221	171	372,10	600	454	350	684,37
800	332	252	195	390,36	686	519	400	713,82
900	374	284	220	408,62	771	584	450	743,26
1.000	415	315	244	426,88	857	648	500	772,70
1.100	457	347	269	445,14	943	713	550	802,14
1.200	498	378	293	463,40	1.028	778	600	831,58
1.300	540	410	318	481,66	1.114	843	650	861,03
1.400	581	442	342	499,92	1.200	908	700	890,47
1.500	623	473	366	518,19	1.286	973	750	919,91
1.600	664	505	391	536,45	1.371	1.037	800	949,35
1.700	706	536	415	554,71	1.457	1.102	850	978,79
1.800	747	568	440	572,97	1.543	1.167	900	1.008,24
1.900	789	599	464	591,23	1.628	1.232	950	1.037,68
2.000	830	631	489	609,49	1.714	1.297	1.000	1.067,12
2.200	913	694	537	646,01	1.885	1.426	1.100	1.126,00
2.400	996	757	586	682,53	2.057	1.556	1.200	1.184,89
2.600	1.079	820	635	719,06	2.228	1.686	1.300	1.243,77
2.800	1.162	883	684	755,58	2.400	1.816	1.400	1.302,66
3.000	1.245	946	733	792,10	2.571	1.945	1.501	1.361,54
3.200	1.328	1.009	782	828,62	2.742	2.075	1.601	1.420,42
3.400	1.411	1.072	831	865,14	2.914	2.205	1.701	1.479,31
3.600	1.494	1.135	879	901,67	3.085	2.334	1.801	1.538,19
3.800	1.577	1.198	928	938,19	3.257	2.464	1.901	1.597,08
4.000	1.660	1.262	977	974,71	3.428	2.594	2.001	1.655,96
4.200	1.743	1.325	1.026	1.011,23	3.599	2.723	2.101	1.714,84
4.400	1.826	1.388	1.075	1.047,75	3.771	2.853	2.201	1.773,73
4.600	1.909	1.451	1.124	1.084,28	3.942	2.983	2.301	1.832,61
4.800	1.992	1.514	1.173	1.120,80	4.114	3.112	2.401	1.891,50
5.000	2.075	1.577	1.222	1.157,32	4.285	3.242	2.501	1.950,38
5.200	2.158	1.640	1.270	1.193,84	4.456	3.372	2.601	2.009,26
5.400	2.241	1.703	1.319	1.230,36	4.628	3.501	2.701	2.068,15
5.600	2.324	1.766	1.368	1.266,89	4.799	3.631	2.801	2.127,03
5.800	2.407	1.829	1.417	1.303,41	4.971	3.761	2.901	2.185,92
6.000	2.490	1.892	1.466	1.339,93	5.142	3.890	3.001	2.244,80

Precios para color blanco estándar RAL 9016.  
Precios para carta de colores Zehnder +25%. Otros colores, consultar.

# Zehnder Nova

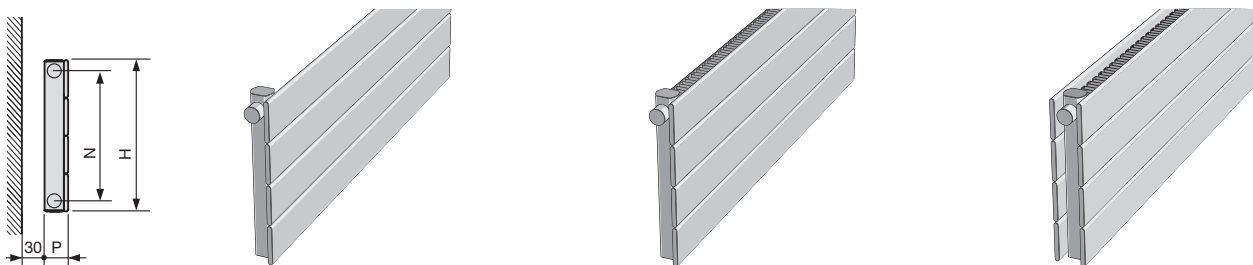

MODELO	NH 28	NHL 28/28	NHLH 28/28
Altura H	283 mm	283 mm	283 mm
Entre ejes N	243 mm	243 mm	243 mm
Profundidad P	45 mm	45 mm	53 mm
Exponente n	1,24	1,26	1,29

Recuerde pedir el Pack de Conexión

Longitud L mm	NH 28				NHL 28/28				NHLH 28/28			
	Emisión EN 442 75/65/20 ΔT 50K W	Emisión Caldera condens. ΔT 40K W	Emisión Bomba de calor ΔT 32,5K W	Blanco RAL 9016 PVP €	Emisión EN 442 75/65/20 ΔT 50K W	Emisión Caldera condens. ΔT 40K W	Emisión Bomba de calor ΔT 32,5K W	Blanco RAL 9016 PVP €	Emisión EN 442 75/65/20 ΔT 50K W	Emisión Caldera condens. ΔT 40K W	Emisión Bomba de calor ΔT 32,5K W	Blanco RAL 9016 PVP €
500	162	122	95	249,15	273	206	158	348,66	365	274	209	547,60
600	194	147	114	260,62	327	247	190	366,26	438	328	251	580,18
700	226	171	133	272,09	382	288	222	383,86	511	383	293	612,76
800	258	196	151	283,56	436	329	253	401,46	584	438	335	645,35
900	291	220	170	295,03	491	370	285	419,06	657	493	377	677,93
1.000	323	245	189	306,50	545	411	317	436,66	730	547	419	710,51
1.100	355	269	208	317,97	600	453	348	454,26	803	602	461	743,09
1.200	388	294	227	329,44	654	494	380	471,86	876	657	503	775,67
1.300	420	318	246	340,91	709	535	412	489,46	949	712	544	808,26
1.400	452	343	265	352,38	763	576	443	507,06	1.022	766	586	840,84
1.500	485	367	284	363,86	818	617	475	524,66	1.095	821	628	873,42
1.600	517	392	303	375,33	872	658	507	542,26	1.168	876	670	906,00
1.700	549	416	322	386,80	927	699	538	559,86	1.241	931	712	938,58
1.800	581	441	341	398,27	981	741	570	577,46	1.314	985	754	971,17
1.900	614	465	360	409,74	1.036	782	602	595,06	1.387	1.040	796	1.003,75
2.000	646	490	379	421,21	1.090	823	633	612,66	1.460	1.095	838	1.036,33
2.200	711	539	417	444,15	1.199	905	697	647,86	1.606	1.204	921	1.101,49
2.400	775	588	454	467,09	1.308	987	760	683,06	1.752	1.314	1.005	1.166,66
2.600	840	637	492	490,04	1.417	1.070	823	718,26	1.898	1.423	1.089	1.231,82
2.800	904	686	530	512,98	1.526	1.152	887	753,46	2.044	1.533	1.173	1.296,99
3.000	969	735	568	535,92	1.635	1.234	950	788,66	2.190	1.642	1.256	1.362,15
3.200	1.034	784	606	558,86	1.744	1.317	1.013	823,86	2.336	1.752	1.340	1.427,31
3.400	1.098	833	644	581,80	1.853	1.399	1.077	859,06	2.482	1.861	1.424	1.492,48
3.600	1.163	882	682	604,75	1.962	1.481	1.140	894,26	2.628	1.971	1.508	1.557,64
3.800	1.227	931	719	627,69	2.071	1.563	1.204	929,46	2.774	2.080	1.591	1.622,81
4.000	1.292	980	757	650,63	2.180	1.646	1.267	964,66	2.920	2.190	1.675	1.687,97
4.200	1.357	1.029	795	673,57	2.289	1.728	1.330	999,86	3.066	2.299	1.759	1.753,13
4.400	1.421	1.078	833	696,51	2.398	1.810	1.394	1.035,06	3.212	2.409	1.843	1.818,30
4.600	1.486	1.127	871	719,46	2.507	1.893	1.457	1.070,26	3.358	2.518	1.926	1.883,46
4.800	1.550	1.176	909	742,40	2.616	1.975	1.520	1.105,46	3.504	2.628	2.010	1.948,63
5.000	1.615	1.225	947	765,34	2.725	2.057	1.584	1.140,66	3.650	2.737	2.094	2.013,79
5.200	1.680	1.274	985	788,28	2.834	2.139	1.647	1.175,86	3.796	2.847	2.178	2.078,95
5.400	1.744	1.323	1.022	811,22	2.943	2.222	1.710	1.211,06	3.942	2.956	2.261	2.144,12
5.600	1.809	1.372	1.060	834,17	3.052	2.304	1.774	1.246,26	4.088	3.065	2.345	2.209,28
5.800	1.873	1.421	1.098	857,11	3.161	2.386	1.837	1.281,46	4.234	3.175	2.429	2.274,45
6.000	1.938	1.470	1.136	880,05	3.270	2.469	1.900	1.316,66	4.380	3.284	2.513	2.339,61

Precios para color blanco estándar RAL 9016.

Precios para carta de colores Zehnder +25%. Otros colores, consultar.



# Zehnder Nova

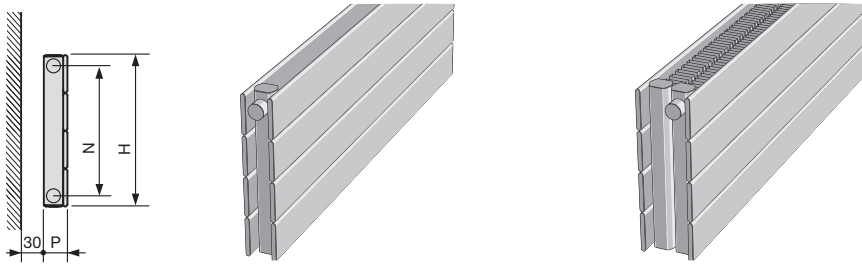

MODELO	NHH 28	NHLH 28/28
Altura H	283 mm	283 mm
Entre ejes N	243 mm	243 mm
Profundidad P	53 mm	92 mm
Exponente n	1,24	1,28

Recuerde pedir el Pack de Conexión

Longitud L mm	Emisión EN 442 75/65/20 ΔT 50K W	Emisión Caldera condens. ΔT 40K W	Emisión Bomba de calor ΔT 32,5K W	Blanco RAL 9016 PVP €	Emisión EN 442 75/65/20 ΔT 50K W	Emisión Caldera condens. ΔT 40K W	Emisión Bomba de calor ΔT 32,5K W	Blanco RAL 9016 PVP €
500	261	198	153	399,94	531	399	306	698,83
600	313	237	184	423,11	637	479	367	734,96
700	365	277	214	446,28	743	559	428	771,10
800	418	317	245	469,45	850	639	489	807,24
900	470	356	275	492,62	956	718	551	843,38
1.000	522	396	306	515,79	1.062	798	612	879,52
1.100	574	435	337	538,96	1.168	878	673	915,66
1.200	626	475	367	562,13	1.274	958	734	951,80
1.300	679	515	398	585,30	1.381	1.038	795	987,94
1.400	731	554	428	608,47	1.487	1.117	857	1.024,08
1.500	783	594	459	631,65	1.593	1.197	918	1.060,22
1.600	835	633	490	654,82	1.699	1.277	979	1.096,35
1.700	887	673	520	677,99	1.805	1.357	1.040	1.132,49
1.800	940	712	551	701,16	1.912	1.437	1.101	1.168,63
1.900	992	752	581	724,33	2.018	1.516	1.163	1.204,77
2.000	1.044	792	612	747,50	2.124	1.596	1.224	1.240,91
2.200	1.148	871	673	793,84	2.336	1.756	1.346	1.313,19
2.400	1.253	950	734	840,18	2.549	1.916	1.468	1.385,47
2.600	1.357	1.029	796	886,53	2.761	2.075	1.591	1.457,74
2.800	1.462	1.108	857	932,87	2.974	2.235	1.713	1.530,02
3.000	1.566	1.187	918	979,21	3.186	2.394	1.836	1.602,30
3.200	1.670	1.267	979	1.025,55	3.398	2.554	1.958	1.674,58
3.400	1.775	1.346	1.040	1.071,89	3.611	2.714	2.080	1.746,86
3.600	1.879	1.425	1.102	1.118,24	3.823	2.873	2.203	1.819,13
3.800	1.984	1.504	1.163	1.164,58	4.036	3.033	2.325	1.891,41
4.000	2.088	1.583	1.224	1.210,92	4.248	3.193	2.447	1.963,69
4.200	2.192	1.662	1.285	1.257,26	4.460	3.352	2.570	2.035,97
4.400	2.297	1.742	1.346	1.303,60	4.673	3.512	2.692	2.108,25
4.600	2.401	1.821	1.407	1.349,95	4.885	3.671	2.815	2.180,52
4.800	2.506	1.900	1.469	1.396,29	5.098	3.831	2.937	2.252,80
5.000	2.610	1.979	1.530	1.442,63	5.310	3.991	3.059	2.325,08
5.200	2.714	2.058	1.591	1.488,97	5.522	4.150	3.182	2.397,36
5.400	2.819	2.137	1.652	1.535,31	5.735	4.310	3.304	2.469,64
5.600	2.923	2.217	1.713	1.581,66	5.947	4.470	3.426	2.541,91
5.800	3.028	2.296	1.775	1.628,00	6.160	4.629	3.549	2.614,19
6.000	3.132	2.375	1.836	1.674,34	6.372	4.789	3.671	2.686,47

Precios para color blanco estándar RAL 9016.  
Precios para carta de colores Zehnder +25%. Otros colores, consultar.

# Zehnder Nova

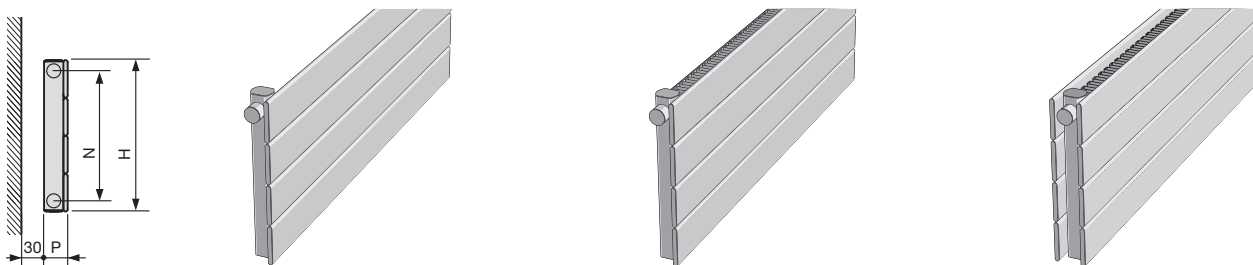

MODELO	NH 35	NHL 35/35	NHLH 35/35
Altura H	354 mm	354 mm	354 mm
Entre ejes N	314 mm	314 mm	314 mm
Profundidad P	45 mm	60 mm	53 mm
Exponente n	1,24	1,27	1,30

Recuerde pedir el Pack de Conexión

Longitud L mm	Emisión EN 442 75/65/20 ΔT 50K W	Emisión Caldera condens. ΔT 40K W	Emisión Bomba de calor ΔT 32,5K W	Blanco RAL 9016 PVP €	Emisión EN 442 75/65/20 ΔT 50K W	Emisión Caldera condens. ΔT 40K W	Emisión Bomba de calor ΔT 32,5K W	Blanco RAL 9016 PVP €	Emisión EN 442 75/65/20 ΔT 50K W	Emisión Caldera condens. ΔT 40K W	Emisión Bomba de calor ΔT 32,5K W	Blanco RAL 9016 PVP €
	500	196	148	115	281,14	355	267	205	383,53	425	318	243
600	235	178	138	295,07	426	321	246	404,36	510	382	291	661,84
700	274	208	160	309,00	497	374	288	425,19	595	445	340	700,23
800	313	237	183	322,92	568	428	329	446,02	680	509	388	738,62
900	352	267	206	336,85	639	481	370	466,85	765	572	437	777,01
1.000	391	296	229	350,78	710	535	411	487,68	850	636	486	815,40
1.100	430	326	252	364,71	781	588	452	508,51	935	700	534	853,79
1.200	469	356	275	378,64	852	642	493	529,34	1.020	763	583	892,18
1.300	508	385	298	392,56	923	695	534	550,17	1.105	827	631	930,57
1.400	547	415	321	406,49	994	749	575	571,00	1.190	890	680	968,96
1.500	587	445	344	420,42	1.065	802	616	591,84	1.275	954	728	1.007,35
1.600	626	474	367	434,35	1.136	856	657	612,67	1.360	1.018	777	1.045,74
1.700	665	504	390	448,28	1.207	909	698	633,50	1.445	1.081	825	1.084,13
1.800	704	534	413	462,20	1.278	963	739	654,33	1.530	1.145	874	1.122,52
1.900	743	563	435	476,13	1.349	1.016	781	675,16	1.615	1.208	922	1.160,91
2.000	782	593	458	490,06	1.420	1.070	822	695,99	1.700	1.272	971	1.199,30
2.200	860	652	504	517,92	1.562	1.177	904	737,65	1.870	1.399	1.068	1.276,08
2.400	938	712	550	545,77	1.704	1.283	986	779,31	2.040	1.526	1.165	1.352,86
2.600	1.017	771	596	573,63	1.846	1.390	1.068	820,98	2.210	1.654	1.262	1.429,64
2.800	1.095	830	642	601,48	1.988	1.497	1.150	862,64	2.380	1.781	1.359	1.506,42
3.000	1.173	889	688	629,34	2.130	1.604	1.232	904,30	2.550	1.908	1.457	1.583,20
3.200	1.251	949	733	657,20	2.272	1.711	1.315	945,96	2.720	2.035	1.554	1.659,98
3.400	1.329	1.008	779	685,05	2.414	1.818	1.397	987,62	2.890	2.162	1.651	1.736,76
3.600	1.408	1.067	825	712,91	2.556	1.925	1.479	1.029,29	3.060	2.289	1.748	1.813,54
3.800	1.486	1.127	871	740,76	2.698	2.032	1.561	1.070,95	3.230	2.417	1.845	1.890,32
4.000	1.564	1.186	917	768,62	2.840	2.139	1.643	1.112,61	3.400	2.544	1.942	1.967,10
4.200	1.642	1.245	963	796,48	2.982	2.246	1.725	1.154,27	3.570	2.671	2.039	2.043,88
4.400	1.720	1.305	1.008	824,33	3.124	2.353	1.808	1.195,93	3.740	2.798	2.136	2.120,66
4.600	1.799	1.364	1.054	852,19	3.266	2.460	1.890	1.237,60	3.910	2.925	2.233	2.197,44
4.800	1.877	1.423	1.100	880,04	3.408	2.567	1.972	1.279,26	4.080	3.053	2.330	2.274,22
5.000	1.955	1.482	1.146	907,90	3.550	2.674	2.054	1.320,92	4.250	3.180	2.428	2.351,00
5.200	2.033	1.542	1.192	935,76	3.692	2.781	2.136	1.362,58	4.420	3.307	2.525	2.427,78
5.400	2.111	1.601	1.238	963,61	3.834	2.888	2.218	1.404,24	4.590	3.434	2.622	2.504,56
5.600	2.190	1.660	1.283	991,47	3.976	2.995	2.301	1.445,91	4.760	3.561	2.719	2.581,34
5.800	2.268	1.720	1.329	1.019,32	4.118	3.102	2.383	1.487,57	4.930	3.689	2.816	2.658,12
6.000	2.346	1.779	1.375	1.047,18	4.260	3.209	2.465	1.529,23	5.100	3.816	2.913	2.734,90

Precios para color blanco estándar RAL 9016.

Precios para carta de colores Zehnder +25%. Otros colores, consultar.



# Zehnder Nova

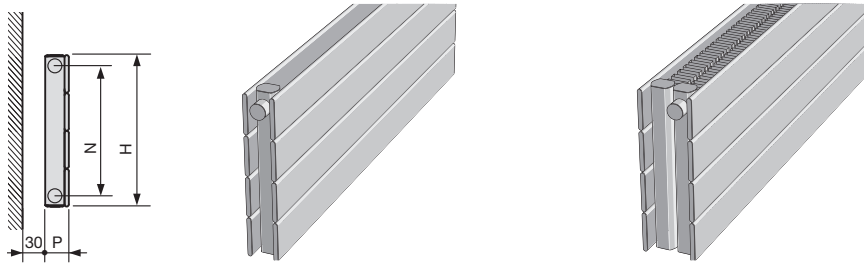

MODELO	NHH 35	NHLH 35/35
Altura H	354 mm	354 mm
Entre ejes N	314 mm	314 mm
Profundidad P	53 mm	92 mm
Exponente n	1,26	1,30

Recuerde pedir el Pack de Conexión

Longitud L mm	Emisión EN 442 75/65/20 ΔT 50K W	Emisión Caldera condens. ΔT 40K W	Emisión Bomba de calor ΔT 32,5K W	Blanco RAL 9016 PVP €	Emisión EN 442 75/65/20 ΔT 50K W	Emisión Caldera condens. ΔT 40K W	Emisión Bomba de calor ΔT 32,5K W	Blanco RAL 9016 PVP €
500	313	236	182	464,28	625	468	357	772,09
600	376	284	218	492,36	750	561	428	814,93
700	438	331	255	520,45	875	655	500	857,76
800	501	378	291	548,54	1.000	748	571	900,60
900	563	425	327	576,63	1.125	842	643	943,43
1.000	626	473	364	604,72	1.250	935	714	986,27
1.100	689	520	400	632,81	1.375	1.029	785	1.029,11
1.200	751	567	437	660,90	1.500	1.122	857	1.071,94
1.300	814	614	473	688,99	1.625	1.216	928	1.114,78
1.400	876	662	509	717,08	1.750	1.309	1.000	1.157,61
1.500	939	709	546	745,17	1.875	1.403	1.071	1.200,45
1.600	1.002	756	582	773,25	2.000	1.496	1.142	1.243,29
1.700	1.064	803	618	801,34	2.125	1.590	1.214	1.286,12
1.800	1.127	851	655	829,43	2.250	1.683	1.285	1.328,96
1.900	1.189	898	691	857,52	2.375	1.777	1.357	1.371,79
2.000	1.252	945	728	885,61	2.500	1.870	1.428	1.414,63
2.200	1.377	1.040	800	941,79	2.750	2.058	1.571	1.500,30
2.400	1.502	1.134	873	997,97	3.000	2.245	1.714	1.585,97
2.600	1.628	1.229	946	1.054,14	3.250	2.432	1.856	1.671,65
2.800	1.753	1.323	1.019	1.110,32	3.500	2.619	1.999	1.757,32
3.000	1.878	1.418	1.091	1.166,50	3.750	2.806	2.142	1.842,99
3.200	2.003	1.512	1.164	1.222,68	4.000	2.993	2.285	1.928,66
3.400	2.128	1.607	1.237	1.278,86	4.250	3.180	2.428	2.014,33
3.600	2.254	1.701	1.310	1.335,03	4.500	3.367	2.570	2.100,01
3.800	2.379	1.796	1.382	1.391,21	4.750	3.554	2.713	2.185,68
4.000	2.504	1.890	1.455	1.447,39	5.000	3.741	2.856	2.271,35
4.200	2.629	1.985	1.528	1.503,57	5.250	3.928	2.999	2.357,02
4.400	2.754	2.079	1.601	1.559,75	5.500	4.115	3.142	2.442,69
4.600	2.880	2.174	1.673	1.615,92	5.750	4.302	3.284	2.528,37
4.800	3.005	2.268	1.746	1.672,10	6.000	4.489	3.427	2.614,04
5.000	3.130	2.363	1.819	1.728,28	6.250	4.676	3.570	2.699,71
5.200	3.255	2.457	1.892	1.784,46	6.500	4.863	3.713	2.785,38
5.400	3.380	2.552	1.964	1.840,64	6.750	5.050	3.856	2.871,05
5.600	3.506	2.646	2.037	1.896,81	7.000	5.237	3.998	2.956,73
5.800	3.631	2.741	2.110	1.952,99	7.250	5.424	4.141	3.042,40
6.000	3.756	2.835	2.183	2.009,17	7.500	5.611	4.284	3.128,07

Precios para color blanco estándar RAL 9016.

Precios para carta de colores Zehnder +25%. Otros colores, consultar.



# Zehnder Nova

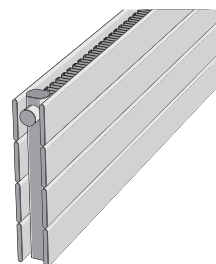
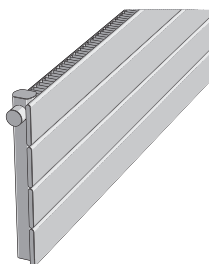
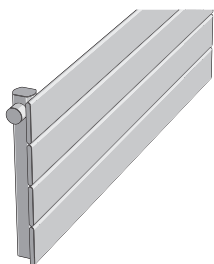
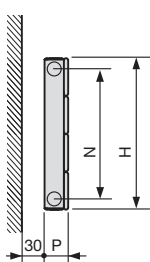

MODELO	NH 42	NHL 42/42	NHLH 42/42
Altura H	425 mm	425 mm	425 mm
Entre ejes N	385 mm	385 mm	385 mm
Profundidad P	45 mm	60 mm	53 mm
Exponente n	1,24	1,27	1,32

Recuerde pedir el Pack de Conexión

Longitud L mm	Emisión EN 442 75/65/20 ΔT 50K W	Emisión Caldera condens. ΔT 40K W	Emisión Bomba de calor ΔT 32,5K W	Blanco RAL 9016 PVP €	Emisión EN 442 75/65/20 ΔT 50K W	Emisión Caldera condens. ΔT 40K W	Emisión Bomba de calor ΔT 32,5K W	Blanco RAL 9016 PVP €	Emisión EN 442 75/65/20 ΔT 50K W	Emisión Caldera condens. ΔT 40K W	Emisión Bomba de calor ΔT 32,5K W	Blanco RAL 9016 PVP €
500	230	174	135	295,98	407	307	236	418,42	481	358	272	682,12
600	275	209	161	313,67	488	368	283	442,48	577	430	327	727,62
700	321	244	188	331,37	570	429	330	466,54	673	502	381	773,13
800	367	278	215	349,07	651	490	377	490,60	770	573	436	818,64
900	413	313	242	366,76	733	552	424	514,67	866	645	490	864,14
1.000	459	348	269	384,46	814	613	471	538,73	962	717	545	909,65
1.100	505	383	296	402,16	895	674	518	562,79	1.058	788	599	955,16
1.200	551	418	323	419,85	977	736	565	586,86	1.154	860	654	1.000,66
1.300	597	452	350	437,55	1.058	797	612	610,92	1.251	932	708	1.046,17
1.400	643	487	377	455,25	1.140	858	659	634,98	1.347	1.003	763	1.091,68
1.500	689	522	404	472,95	1.221	920	707	659,05	1.443	1.075	817	1.137,19
1.600	734	557	430	490,64	1.302	981	754	683,11	1.539	1.146	872	1.182,69
1.700	780	592	457	508,34	1.384	1.042	801	707,17	1.635	1.218	926	1.228,20
1.800	826	626	484	526,04	1.465	1.104	848	731,23	1.732	1.290	981	1.273,71
1.900	872	661	511	543,73	1.547	1.165	895	755,30	1.828	1.361	1.035	1.319,21
2.000	918	696	538	561,43	1.628	1.226	942	779,36	1.924	1.433	1.090	1.364,72
2.200	1.010	766	592	596,82	1.791	1.349	1.036	827,49	2.116	1.576	1.199	1.455,73
2.400	1.102	835	646	632,22	1.954	1.471	1.130	875,61	2.309	1.720	1.307	1.546,75
2.600	1.193	905	700	667,61	2.116	1.594	1.225	923,74	2.501	1.863	1.416	1.637,76
2.800	1.285	975	753	703,01	2.279	1.717	1.319	971,86	2.694	2.006	1.525	1.728,78
3.000	1.377	1.044	807	738,40	2.442	1.839	1.413	1.019,99	2.886	2.150	1.634	1.819,79
3.200	1.469	1.114	861	773,79	2.605	1.962	1.507	1.068,12	3.078	2.293	1.743	1.910,80
3.400	1.561	1.183	915	809,19	2.768	2.085	1.601	1.116,24	3.271	2.436	1.852	2.001,82
3.600	1.652	1.253	969	844,58	2.930	2.207	1.696	1.164,37	3.463	2.580	1.961	2.092,83
3.800	1.744	1.323	1.022	879,98	3.093	2.330	1.790	1.212,49	3.656	2.723	2.070	2.183,85
4.000	1.836	1.392	1.076	915,37	3.256	2.452	1.884	1.260,62	3.848	2.866	2.179	2.274,86
4.200	1.928	1.462	1.130	950,76	3.419	2.575	1.978	1.308,75	4.040	3.010	2.288	2.365,87
4.400	2.020	1.531	1.184	986,16	3.582	2.698	2.072	1.356,87	4.233	3.153	2.397	2.456,89
4.600	2.111	1.601	1.238	1.021,55	3.744	2.820	2.167	1.405,00	4.425	3.296	2.506	2.547,90
4.800	2.203	1.671	1.291	1.056,95	3.907	2.943	2.261	1.453,12	4.618	3.439	2.615	2.638,92
5.000	2.295	1.740	1.345	1.092,34	4.070	3.066	2.355	1.501,25	4.810	3.583	2.724	2.729,93
5.200	2.387	1.810	1.399	1.127,73	4.233	3.188	2.449	1.549,38	5.002	3.726	2.833	2.820,94
5.400	2.479	1.879	1.453	1.163,13	4.396	3.311	2.543	1.597,50	5.195	3.869	2.942	2.911,96
5.600	2.570	1.949	1.507	1.198,52	4.558	3.433	2.638	1.645,63	5.387	4.013	3.051	3.002,97
5.800	2.662	2.019	1.560	1.233,92	4.721	3.556	2.732	1.693,75	5.580	4.156	3.160	3.093,99
6.000	2.754	2.088	1.614	1.269,31	4.884	3.679	2.826	1.741,88	5.772	4.299	3.269	3.185,00

Precios para color blanco estándar RAL 9016.

Precios para carta de colores Zehnder +25%. Otros colores, consultar.



# Zehnder Nova

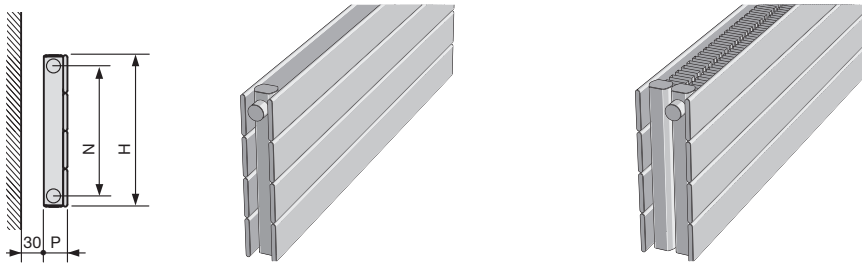

MODELO	NHH 42	NHLH 42/42
Altura H	425 mm	425 mm
Entre ejes N	385 mm	385 mm
Profundidad P	53 mm	92 mm
Exponente n	1,26	1,31

Recuerde pedir el Pack de Conexión

Longitud L mm	Emisión EN 442 75/65/20 ΔT 50K W	Emisión Caldera condens. ΔT 40K W	Emisión Bomba de calor ΔT 32,5K W	Blanco RAL 9016 PVP €	Emisión EN 442 75/65/20 ΔT 50K W	Emisión Caldera condens. ΔT 40K W	Emisión Bomba de calor ΔT 32,5K W	Blanco RAL 9016 PVP €
500	365	275	212	528,62	712	532	405	845,31
600	437	330	254	561,62	854	638	486	894,83
700	510	385	297	594,62	997	744	567	944,36
800	583	440	339	627,62	1.139	850	648	993,88
900	656	495	381	660,62	1.282	957	729	1.043,41
1.000	729	550	424	693,62	1.424	1.063	810	1.092,93
1.100	802	605	466	726,62	1.566	1.169	891	1.142,45
1.200	875	660	508	759,62	1.709	1.276	972	1.191,98
1.300	948	715	551	792,62	1.851	1.382	1.053	1.241,50
1.400	1.021	770	593	825,62	1.994	1.488	1.134	1.291,03
1.500	1.094	825	635	858,63	2.136	1.595	1.215	1.340,55
1.600	1.166	881	678	891,63	2.278	1.701	1.296	1.390,07
1.700	1.239	936	720	924,63	2.421	1.807	1.377	1.439,60
1.800	1.312	991	763	957,63	2.563	1.914	1.458	1.489,12
1.900	1.385	1.046	805	990,63	2.706	2.020	1.539	1.538,65
2.000	1.458	1.101	847	1.023,63	2.848	2.126	1.620	1.588,17
2.200	1.604	1.211	932	1.089,63	3.133	2.339	1.782	1.687,22
2.400	1.750	1.321	1.017	1.155,63	3.418	2.551	1.944	1.786,27
2.600	1.895	1.431	1.101	1.221,64	3.702	2.764	2.106	1.885,31
2.800	2.041	1.541	1.186	1.287,64	3.987	2.977	2.268	1.984,36
3.000	2.187	1.651	1.271	1.353,64	4.272	3.189	2.430	2.083,41
3.200	2.333	1.761	1.356	1.419,64	4.557	3.402	2.592	2.182,46
3.400	2.479	1.871	1.440	1.485,64	4.842	3.614	2.754	2.281,51
3.600	2.624	1.981	1.525	1.551,65	5.126	3.827	2.916	2.380,55
3.800	2.770	2.091	1.610	1.617,65	5.411	4.040	3.078	2.479,60
4.000	2.916	2.201	1.695	1.683,65	5.696	4.252	3.240	2.578,65
4.200	3.062	2.311	1.779	1.749,65	5.981	4.465	3.402	2.677,70
4.400	3.208	2.421	1.864	1.815,65	6.266	4.677	3.564	2.776,75
4.600	3.353	2.532	1.949	1.881,66	6.550	4.890	3.725	2.875,79
4.800	3.499	2.642	2.033	1.947,66	6.835	5.103	3.887	2.974,84
5.000	3.645	2.752	2.118	2.013,66	7.120	5.315	4.049	3.073,89
5.200	3.791	2.862	2.203	2.079,66	7.405	5.528	4.211	3.172,94
5.400	3.937	2.972	2.288	2.145,66	7.690	5.741	4.373	3.271,99
5.600	4.082	3.082	2.372	2.211,67	7.974	5.953	4.535	3.371,03
5.800	4.228	3.192	2.457	2.277,67	8.259	6.166	4.697	3.470,08
6.000	4.374	3.302	2.542	2.343,67	8.544	6.378	4.859	3.569,13

Precios para color blanco estándar RAL 9016.

Precios para carta de colores Zehnder +25%. Otros colores, consultar.





# Zehnder Nova

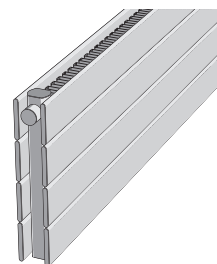
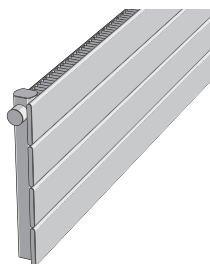
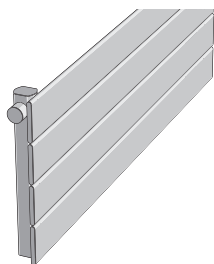
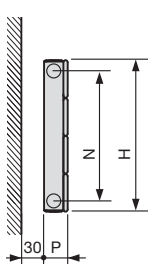

MODELO	NH 49	NHL 49/49	NHLH 49/49
Altura H	496 mm	496 mm	496 mm
Entre ejes N	456 mm	456 mm	456 mm
Profundidad P	45 mm	60 mm	53 mm
Exponente n	1,24	1,28	1,33

Recuerde pedir el Pack de Conexión

Longitud L mm	Emisión EN 442 75/65/20 ΔT 50K W	Emisión Caldera condens. ΔT 40K W	Emisión Bomba de calor ΔT 32,5K W	Blanco RAL 9016 PVP €	Emisión EN 442 75/65/20 ΔT 50K W	Emisión Caldera condens. ΔT 40K W	Emisión Bomba de calor ΔT 32,5K W	Blanco RAL 9016 PVP €	Emisión EN 442 75/65/20 ΔT 50K W	Emisión Caldera condens. ΔT 40K W	Emisión Bomba de calor ΔT 32,5K W	Blanco RAL 9016 PVP €
500	264	200	154	345,00	459	345	264	453,33	536	398	302	775,16
600	316	240	185	363,84	550	414	317	480,62	643	478	363	825,16
700	369	280	216	382,68	642	482	370	507,91	750	558	423	875,15
800	422	320	247	401,51	734	551	423	535,20	858	637	484	925,15
900	474	360	278	420,35	825	620	475	562,49	965	717	544	975,14
1.000	527	400	309	439,19	917	689	528	589,78	1.072	797	604	1.025,14
1.100	580	440	340	458,03	1.009	758	581	617,07	1.179	876	665	1.075,14
1.200	632	480	371	476,87	1.100	827	634	644,36	1.286	956	725	1.125,13
1.300	685	519	402	495,70	1.192	896	687	671,65	1.394	1.036	786	1.175,13
1.400	738	559	432	514,54	1.284	965	740	698,94	1.501	1.115	846	1.225,12
1.500	791	599	463	533,38	1.376	1.034	792	726,24	1.608	1.195	907	1.275,12
1.600	843	639	494	552,22	1.467	1.103	845	753,53	1.715	1.275	967	1.325,12
1.700	896	679	525	571,06	1.559	1.172	898	780,82	1.822	1.354	1.028	1.375,11
1.800	949	719	556	589,89	1.651	1.241	951	808,11	1.930	1.434	1.088	1.425,11
1.900	1.001	759	587	608,73	1.742	1.309	1.004	835,40	2.037	1.514	1.148	1.475,10
2.000	1.054	799	618	627,57	1.834	1.378	1.057	862,69	2.144	1.593	1.209	1.525,10
2.200	1.159	879	680	665,25	2.017	1.516	1.162	917,27	2.358	1.753	1.330	1.625,09
2.400	1.265	959	741	702,92	2.201	1.654	1.268	971,85	2.573	1.912	1.451	1.725,08
2.600	1.370	1.039	803	740,60	2.384	1.792	1.374	1.026,44	2.787	2.071	1.572	1.825,08
2.800	1.476	1.119	865	778,27	2.568	1.930	1.479	1.081,02	3.002	2.231	1.692	1.925,07
3.000	1.581	1.199	927	815,95	2.751	2.068	1.585	1.135,60	3.216	2.390	1.813	2.025,06
3.200	1.686	1.279	988	853,63	2.934	2.205	1.691	1.190,18	3.430	2.549	1.934	2.125,05
3.400	1.792	1.359	1.050	891,30	3.118	2.343	1.796	1.244,76	3.645	2.709	2.055	2.225,04
3.600	1.897	1.439	1.112	928,98	3.301	2.481	1.902	1.299,35	3.859	2.868	2.176	2.325,04
3.800	2.003	1.519	1.174	966,65	3.485	2.619	2.008	1.353,93	4.074	3.028	2.297	2.425,03
4.000	2.108	1.598	1.236	1.004,33	3.668	2.757	2.113	1.408,51	4.288	3.187	2.418	2.525,02
4.200	2.213	1.678	1.297	1.042,01	3.851	2.895	2.219	1.463,09	4.502	3.346	2.539	2.625,01
4.400	2.319	1.758	1.359	1.079,68	4.035	3.032	2.325	1.517,67	4.717	3.506	2.660	2.725,00
4.600	2.424	1.838	1.421	1.117,36	4.218	3.170	2.430	1.572,26	4.931	3.665	2.781	2.825,00
4.800	2.530	1.918	1.483	1.155,03	4.402	3.308	2.536	1.626,84	5.146	3.824	2.901	2.924,99
5.000	2.635	1.998	1.545	1.192,71	4.585	3.446	2.642	1.681,42	5.360	3.984	3.022	3.024,98
5.200	2.740	2.078	1.606	1.230,39	4.768	3.584	2.747	1.736,00	5.574	4.143	3.143	3.124,97
5.400	2.846	2.158	1.668	1.268,06	4.952	3.722	2.853	1.790,58	5.789	4.302	3.264	3.224,96
5.600	2.951	2.238	1.730	1.305,74	5.135	3.859	2.959	1.845,17	6.003	4.462	3.385	3.324,96
5.800	3.057	2.318	1.792	1.343,41	5.319	3.997	3.064	1.899,75	6.218	4.621	3.506	3.424,95
6.000	3.162	2.398	1.853	1.381,09	5.502	4.135	3.170	1.954,33	6.432	4.780	3.627	3.524,94

Precios para color blanco estándar RAL 9016.

Precios para carta de colores Zehnder +25%. Otros colores, consultar.



# Zehnder Nova

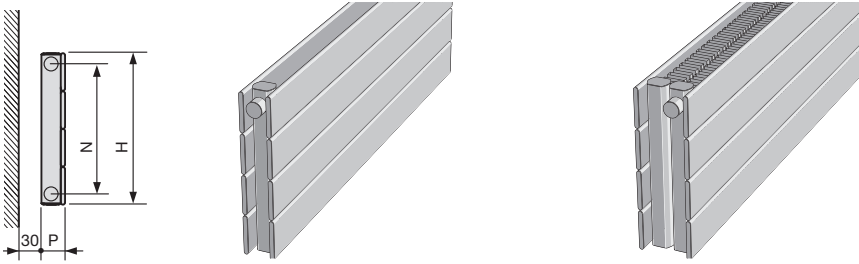

MODELO	NHH 49	NHLH 49/49
Altura H	496 mm	496 mm
Entre ejes N	456 mm	456 mm
Profundidad P	53 mm	92 mm
Exponente n	1,27	1,33

Recuerde pedir el Pack de Conexión

Longitud L mm	Emisión EN 442 75/65/20 ΔT 50K W	Emisión Caldera condens. ΔT 40K W	Emisión Bomba de calor ΔT 32,5K W	Blanco RAL 9016 PVP €	Emisión EN 442 75/65/20 ΔT 50K W	Emisión Caldera condens. ΔT 40K W	Emisión Bomba de calor ΔT 32,5K W	Blanco RAL 9016 PVP €
500	416	313	241	593,01	795	591	448	918,56
600	499	376	289	630,93	954	709	538	974,77
700	582	439	337	668,85	1.113	827	628	1.030,99
800	666	501	385	706,76	1.272	945	717	1.087,21
900	749	564	433	744,68	1.431	1.064	807	1.143,42
1.000	832	627	481	782,60	1.590	1.182	897	1.199,64
1.100	915	689	530	820,52	1.749	1.300	986	1.255,86
1.200	998	752	578	858,44	1.908	1.418	1.076	1.312,07
1.300	1.082	815	626	896,35	2.067	1.536	1.166	1.368,29
1.400	1.165	877	674	934,27	2.226	1.654	1.255	1.424,51
1.500	1.248	940	722	972,19	2.385	1.773	1.345	1.480,73
1.600	1.331	1.003	770	1.010,11	2.544	1.891	1.434	1.536,94
1.700	1.414	1.065	818	1.048,03	2.703	2.009	1.524	1.593,16
1.800	1.498	1.128	867	1.085,94	2.862	2.127	1.614	1.649,38
1.900	1.581	1.191	915	1.123,86	3.021	2.245	1.703	1.705,59
2.000	1.664	1.253	963	1.161,78	3.180	2.363	1.793	1.761,81
2.200	1.830	1.379	1.059	1.237,62	3.498	2.600	1.972	1.874,24
2.400	1.997	1.504	1.155	1.313,45	3.816	2.836	2.152	1.986,68
2.600	2.163	1.629	1.252	1.389,29	4.134	3.072	2.331	2.099,11
2.800	2.330	1.755	1.348	1.465,12	4.452	3.309	2.510	2.211,55
3.000	2.496	1.880	1.444	1.540,96	4.770	3.545	2.690	2.323,98
3.200	2.662	2.005	1.541	1.616,80	5.088	3.781	2.869	2.436,41
3.400	2.829	2.131	1.637	1.692,63	5.406	4.018	3.048	2.548,85
3.600	2.995	2.256	1.733	1.768,47	5.724	4.254	3.228	2.661,28
3.800	3.162	2.381	1.829	1.844,30	6.042	4.490	3.407	2.773,72
4.000	3.328	2.507	1.926	1.920,14	6.360	4.727	3.586	2.886,15
4.200	3.494	2.632	2.022	1.995,98	6.678	4.963	3.765	2.998,58
4.400	3.661	2.757	2.118	2.071,81	6.996	5.199	3.945	3.111,02
4.600	3.827	2.883	2.215	2.147,65	7.314	5.436	4.124	3.223,45
4.800	3.994	3.008	2.311	2.223,48	7.632	5.672	4.303	3.335,89
5.000	4.160	3.133	2.407	2.299,32	7.950	5.908	4.483	3.448,32
5.200	4.326	3.259	2.503	2.375,16	8.268	6.145	4.662	3.560,75
5.400	4.493	3.384	2.600	2.450,99	8.586	6.381	4.841	3.673,19
5.600	4.659	3.509	2.696	2.526,83	8.904	6.618	5.021	3.785,62
5.800	4.826	3.635	2.792	2.602,66	9.222	6.854	5.200	3.898,06
6.000	4.992	3.760	2.889	2.678,50	9.540	7.090	5.379	4.010,49

Precios para color blanco estándar RAL 9016.

Precios para carta de colores Zehnder +25%. Otros colores, consultar.



# Zehnder Nova

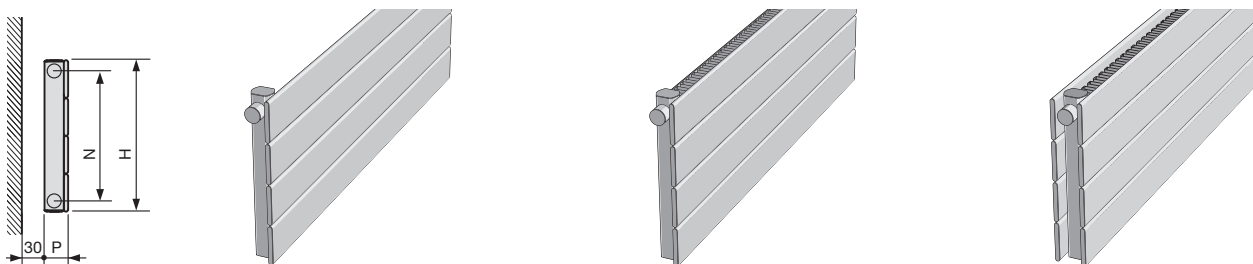

MODELO	NH 56	NHL 56/56	NHLH 56/56
Altura H	567 mm	567 mm	567 mm
Entre ejes N	527 mm	527 mm	527 mm
Profundidad P	45 mm	60 mm	53 mm
Exponente n	1,25	1,29	1,34

Recuerde pedir el Pack de Conexión

Longitud L mm	Emisión EN 442 75/65/20 ΔT 50K W	Emisión Caldera condens. ΔT 40K W	Emisión Bomba de calor ΔT 32,5K W	Blanco RAL 9016 PVP €	Emisión EN 442 75/65/20 ΔT 50K W	Emisión Caldera condens. ΔT 40K W	Emisión Bomba de calor ΔT 32,5K W	Blanco RAL 9016 PVP €	Emisión EN 442 75/65/20 ΔT 50K W	Emisión Caldera condens. ΔT 40K W	Emisión Bomba de calor ΔT 32,5K W	Blanco RAL 9016 PVP €
500	298	225	174	359,85	512	384	294	488,17	593	439	333	833,85
600	358	271	209	382,46	614	461	352	518,69	711	527	399	890,96
700	417	316	243	405,08	717	538	411	549,22	830	615	466	948,08
800	477	361	278	427,69	819	614	470	579,74	948	703	532	1.005,20
900	536	406	313	450,31	922	691	529	610,27	1.067	791	599	1.062,31
1.000	596	451	348	472,92	1.024	768	587	640,79	1.185	879	665	1.119,43
1.100	656	496	383	495,53	1.126	845	646	671,32	1.304	967	732	1.176,55
1.200	715	541	417	518,15	1.229	921	705	701,84	1.422	1.054	798	1.233,66
1.300	775	586	452	540,76	1.331	998	764	732,37	1.541	1.142	865	1.290,78
1.400	834	631	487	563,38	1.434	1.075	822	762,89	1.659	1.230	931	1.347,90
1.500	894	676	522	585,99	1.536	1.152	881	793,42	1.778	1.318	998	1.405,02
1.600	954	721	557	608,60	1.638	1.229	940	823,94	1.896	1.406	1.064	1.462,13
1.700	1.013	767	591	631,22	1.741	1.305	999	854,47	2.015	1.494	1.131	1.519,25
1.800	1.073	812	626	653,83	1.843	1.382	1.057	884,99	2.133	1.582	1.198	1.576,37
1.900	1.132	857	661	676,45	1.946	1.459	1.116	915,52	2.252	1.670	1.264	1.633,48
2.000	1.192	902	696	699,06	2.048	1.536	1.175	946,04	2.370	1.757	1.331	1.690,60
2.200	1.311	992	765	744,29	2.253	1.689	1.292	1.007,09	2.607	1.933	1.464	1.804,83
2.400	1.430	1.082	835	789,52	2.458	1.843	1.410	1.068,14	2.844	2.109	1.597	1.919,07
2.600	1.550	1.172	904	834,74	2.662	1.996	1.527	1.129,19	3.081	2.285	1.730	2.033,30
2.800	1.669	1.263	974	879,97	2.867	2.150	1.645	1.190,24	3.318	2.460	1.863	2.147,54
3.000	1.788	1.353	1.044	925,20	3.072	2.304	1.762	1.251,29	3.555	2.636	1.996	2.261,77
3.200	1.907	1.443	1.113	970,43	3.277	2.457	1.880	1.312,34	3.792	2.812	2.129	2.376,00
3.400	2.026	1.533	1.183	1.015,66	3.482	2.611	1.997	1.373,39	4.029	2.988	2.262	2.490,24
3.600	2.146	1.623	1.252	1.060,88	3.686	2.764	2.115	1.434,44	4.266	3.163	2.395	2.604,47
3.800	2.265	1.714	1.322	1.106,11	3.891	2.918	2.232	1.495,49	4.503	3.339	2.528	2.718,71
4.000	2.384	1.804	1.391	1.151,34	4.096	3.071	2.350	1.556,54	4.740	3.515	2.661	2.832,94
4.200	2.503	1.894	1.461	1.196,57	4.301	3.225	2.467	1.617,59	4.977	3.691	2.794	2.947,17
4.400	2.622	1.984	1.531	1.241,80	4.506	3.379	2.585	1.678,64	5.214	3.866	2.927	3.061,41
4.600	2.742	2.074	1.600	1.287,02	4.710	3.532	2.702	1.739,69	5.451	4.042	3.060	3.175,64
4.800	2.861	2.164	1.670	1.332,25	4.915	3.686	2.820	1.800,74	5.688	4.218	3.193	3.289,88
5.000	2.980	2.255	1.739	1.377,48	5.120	3.839	2.937	1.861,79	5.925	4.394	3.327	3.404,11
5.200	3.099	2.345	1.809	1.422,71	5.325	3.993	3.055	1.922,84	6.162	4.569	3.460	3.518,34
5.400	3.218	2.435	1.878	1.467,94	5.530	4.146	3.172	1.983,89	6.399	4.745	3.593	3.632,58
5.600	3.338	2.525	1.948	1.513,16	5.734	4.300	3.290	2.044,94	6.636	4.921	3.726	3.746,81
5.800	3.457	2.615	2.018	1.558,39	5.939	4.454	3.407	2.105,99	6.873	5.097	3.859	3.861,05
6.000	3.576	2.706	2.087	1.603,62	6.144	4.607	3.525	2.167,04	7.110	5.272	3.992	3.975,28

Precios para color blanco estándar RAL 9016.

Precios para carta de colores Zehnder +25%. Otros colores, consultar.



# Zehnder Nova

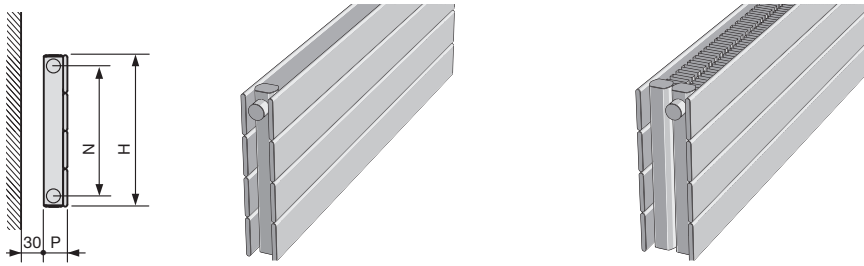

MODELO	NHH 56	NHLH 56/56
Altura H	567 mm	567 mm
Entre ejes N	527 mm	527 mm
Profundidad P	53 mm	92 mm
Exponente n	1,27	1,34

Recuerde pedir el Pack de Conexión

Longitud L mm	Emisión EN 442 75/65/20 ΔT 50K W	Emisión Caldera condens. ΔT 40K W	Emisión Bomba de calor ΔT 32,5K W	Blanco RAL 9016 PVP €	Emisión EN 442 75/65/20 ΔT 50K W	Emisión Caldera condens. ΔT 40K W	Emisión Bomba de calor ΔT 32,5K W	Blanco RAL 9016 PVP €
500	468	353	271	657,41	875	649	491	991,87
600	562	423	325	700,25	1.050	779	590	1.054,79
700	655	494	379	743,08	1.225	908	688	1.117,71
800	749	564	433	785,92	1.400	1.038	786	1.180,62
900	842	635	487	828,75	1.575	1.168	884	1.243,54
1.000	936	705	542	871,59	1.750	1.298	983	1.306,46
1.100	1.030	776	596	914,43	1.925	1.427	1.081	1.369,38
1.200	1.123	846	650	957,26	2.100	1.557	1.179	1.432,30
1.300	1.217	917	704	1.000,10	2.275	1.687	1.277	1.495,21
1.400	1.310	987	758	1.042,93	2.450	1.817	1.376	1.558,13
1.500	1.404	1.058	812	1.085,77	2.625	1.947	1.474	1.621,05
1.600	1.498	1.128	867	1.128,61	2.800	2.076	1.572	1.683,97
1.700	1.591	1.199	921	1.171,44	2.975	2.206	1.670	1.746,89
1.800	1.685	1.269	975	1.214,28	3.150	2.336	1.769	1.809,80
1.900	1.778	1.340	1.029	1.257,11	3.325	2.466	1.867	1.872,72
2.000	1.872	1.410	1.083	1.299,95	3.500	2.595	1.965	1.935,64
2.200	2.059	1.551	1.192	1.385,62	3.850	2.855	2.162	2.061,48
2.400	2.246	1.692	1.300	1.471,29	4.200	3.115	2.358	2.187,31
2.600	2.434	1.833	1.408	1.556,97	4.550	3.374	2.555	2.313,15
2.800	2.621	1.974	1.516	1.642,64	4.900	3.634	2.751	2.438,98
3.000	2.808	2.115	1.625	1.728,31	5.250	3.893	2.948	2.564,82
3.200	2.995	2.256	1.733	1.813,98	5.600	4.153	3.144	2.690,66
3.400	3.182	2.397	1.841	1.899,65	5.950	4.412	3.341	2.816,49
3.600	3.370	2.538	1.950	1.985,33	6.300	4.672	3.537	2.942,33
3.800	3.557	2.679	2.058	2.071,00	6.650	4.931	3.734	3.068,16
4.000	3.744	2.820	2.166	2.156,67	7.000	5.191	3.930	3.194,00
4.200	3.931	2.961	2.275	2.242,34	7.350	5.450	4.127	3.319,84
4.400	4.118	3.102	2.383	2.328,01	7.700	5.710	4.323	3.445,67
4.600	4.306	3.243	2.491	2.413,69	8.050	5.969	4.520	3.571,51
4.800	4.493	3.384	2.600	2.499,36	8.400	6.229	4.716	3.697,34
5.000	4.680	3.525	2.708	2.585,03	8.750	6.489	4.913	3.823,18
5.200	4.867	3.666	2.816	2.670,70	9.100	6.748	5.109	3.949,02
5.400	5.054	3.807	2.925	2.756,37	9.450	7.008	5.306	4.074,85
5.600	5.242	3.948	3.033	2.842,05	9.800	7.267	5.502	4.200,69
5.800	5.429	4.089	3.141	2.927,72	10.150	7.527	5.699	4.326,52
6.000	5.616	4.230	3.250	3.013,39	10.500	7.786	5.895	4.452,36

Precios para color blanco estándar RAL 9016.

Precios para carta de colores Zehnder +25%. Otros colores, consultar.



# Zehnder Nova

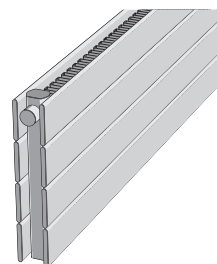
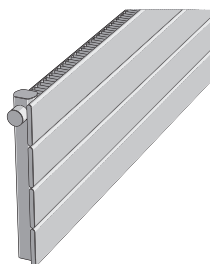
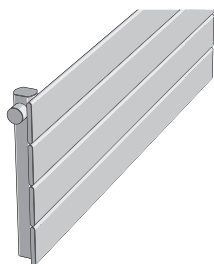
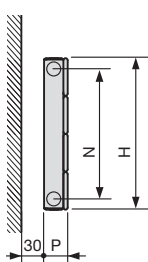

MODELO	NH 63	NHL 63/56	NHLH 63/56
Altura H	638 mm	638 mm	638 mm
Entre ejes N	598 mm	598 mm	598 mm
Profundidad P	45 mm	60 mm	53 mm
Exponente n	1,25	1,29	1,34

Recuerde pedir el Pack de Conexión

Longitud L mm	Emisión EN 442 75/65/20 ΔT 50K W	Emisión Caldera condens. ΔT 40K W	Emisión Bomba de calor ΔT 32,5K W	Blanco RAL 9016 PVP €	Emisión EN 442 75/65/20 ΔT 50K W	Emisión Caldera condens. ΔT 40K W	Emisión Bomba de calor ΔT 32,5K W	Blanco RAL 9016 PVP €	Emisión EN 442 75/65/20 ΔT 50K W	Emisión Caldera condens. ΔT 40K W	Emisión Bomba de calor ΔT 32,5K W	Blanco RAL 9016 PVP €
500	333	252	194	482,64	543	407	312	518,59	633	469	355	922,32
600	400	302	233	521,14	652	489	374	551,46	759	563	426	983,04
700	466	353	272	559,64	760	570	436	584,32	886	657	497	1.043,75
800	533	403	311	598,14	869	651	498	617,19	1.012	750	568	1.104,47
900	599	454	350	636,64	977	733	561	650,05	1.139	844	639	1.165,18
1.000	666	504	389	675,14	1.086	814	623	682,92	1.265	938	710	1.225,90
1.100	733	554	428	713,64	1.195	896	685	715,79	1.392	1.032	781	1.286,62
1.200	799	605	466	752,14	1.303	977	748	748,65	1.518	1.126	852	1.347,33
1.300	866	655	505	790,64	1.412	1.059	810	781,52	1.645	1.219	923	1.408,05
1.400	932	705	544	829,14	1.520	1.140	872	814,38	1.771	1.313	994	1.468,76
1.500	999	756	583	867,65	1.629	1.222	935	847,25	1.898	1.407	1.065	1.529,48
1.600	1.066	806	622	906,15	1.738	1.303	997	880,12	2.024	1.501	1.136	1.590,20
1.700	1.132	857	661	944,65	1.846	1.384	1.059	912,98	2.151	1.595	1.207	1.650,91
1.800	1.199	907	700	983,15	1.955	1.466	1.121	945,85	2.277	1.689	1.278	1.711,63
1.900	1.265	957	739	1.021,65	2.063	1.547	1.184	978,71	2.404	1.782	1.349	1.772,34
2.000	1.332	1.008	777	1.060,15	2.172	1.629	1.246	1.011,58	2.530	1.876	1.420	1.833,06
2.200	1.465	1.109	855	1.137,15	2.389	1.792	1.371	1.077,31	2.783	2.064	1.562	1.954,49
2.400	1.598	1.209	933	1.214,15	2.606	1.954	1.495	1.143,04	3.036	2.251	1.705	2.075,92
2.600	1.732	1.310	1.011	1.291,16	2.824	2.117	1.620	1.208,78	3.289	2.439	1.847	2.197,36
2.800	1.865	1.411	1.088	1.368,16	3.041	2.280	1.744	1.274,51	3.542	2.627	1.989	2.318,79
3.000	1.998	1.512	1.166	1.445,16	3.258	2.443	1.869	1.340,24	3.795	2.814	2.131	2.440,22
3.200	2.131	1.612	1.244	1.522,16	3.475	2.606	1.994	1.405,97	4.048	3.002	2.273	2.561,65
3.400	2.264	1.713	1.322	1.599,16	3.692	2.769	2.118	1.471,70	4.301	3.189	2.415	2.683,08
3.600	2.398	1.814	1.399	1.676,17	3.910	2.932	2.243	1.537,44	4.554	3.377	2.557	2.804,52
3.800	2.531	1.915	1.477	1.753,17	4.127	3.095	2.367	1.603,17	4.807	3.565	2.699	2.925,95
4.000	2.664	2.016	1.555	1.830,17	4.344	3.257	2.492	1.668,90	5.060	3.752	2.841	3.047,38
4.200	2.797	2.116	1.633	1.907,17	4.561	3.420	2.617	1.734,63	5.313	3.940	2.983	3.168,81
4.400	2.930	2.217	1.710	1.984,17	4.778	3.583	2.741	1.800,36	5.566	4.127	3.125	3.290,24
4.600	3.064	2.318	1.788	2.061,18	4.996	3.746	2.866	1.866,10	5.819	4.315	3.267	3.411,68
4.800	3.197	2.419	1.866	2.138,18	5.213	3.909	2.990	1.931,83	6.072	4.503	3.409	3.533,11
5.000	3.330	2.519	1.944	2.215,18	5.430	4.072	3.115	1.997,56	6.325	4.690	3.551	3.654,54
5.200	3.463	2.620	2.021	2.292,18	5.647	4.235	3.240	2.063,29	6.578	4.878	3.693	3.775,97
5.400	3.596	2.721	2.099	2.369,18	5.864	4.398	3.364	2.129,02	6.831	5.066	3.835	3.897,40
5.600	3.730	2.822	2.177	2.446,19	6.082	4.560	3.489	2.194,76	7.084	5.253	3.977	4.018,84
5.800	3.863	2.923	2.254	2.523,19	6.299	4.723	3.613	2.260,49	7.337	5.441	4.119	4.140,27
6.000	3.996	3.023	2.332	2.600,19	6.516	4.886	3.738	2.326,22	7.590	5.628	4.261	4.261,70

Precios para color blanco estándar RAL 9016.

Precios para carta de colores Zehnder +25%. Otros colores, consultar.



# Zehnder Nova

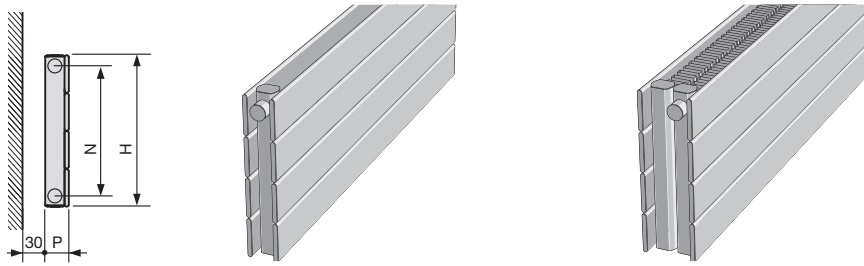

MODELO	NHH 63	NHLH 63/56
Altura H	638 mm	638 mm
Entre ejes N	598 mm	598 mm
Profundidad P	53 mm	92 mm
Exponente n	1,28	1,34

Recuerde pedir el Pack de Conexión

Longitud L mm	Emisión EN 442 75/65/20 ΔT 50K W	Emisión Caldera condens. ΔT 40K W	Emisión Bomba de calor ΔT 32,5K W	Blanco RAL 9016 PVP €	Emisión EN 442 75/65/20 ΔT 50K W	Emisión Caldera condens. ΔT 40K W	Emisión Bomba de calor ΔT 32,5K W	Blanco RAL 9016 PVP €
500	520	391	300	721,79	922	683	517	1.056,23
600	624	469	360	769,53	1.106	820	621	1.124,06
700	728	547	419	817,28	1.290	957	724	1.191,89
800	832	625	479	865,03	1.474	1.093	828	1.259,72
900	936	703	539	912,78	1.659	1.230	931	1.327,56
1.000	1.040	782	599	960,53	1.843	1.367	1.035	1.395,39
1.100	1.144	860	659	1.008,28	2.027	1.503	1.138	1.463,22
1.200	1.248	938	719	1.056,03	2.212	1.640	1.242	1.531,06
1.300	1.352	1.016	779	1.103,78	2.396	1.777	1.345	1.598,89
1.400	1.456	1.094	839	1.151,53	2.580	1.913	1.449	1.666,72
1.500	1.560	1.172	899	1.199,28	2.765	2.050	1.552	1.734,56
1.600	1.664	1.251	959	1.247,02	2.949	2.187	1.656	1.802,39
1.700	1.768	1.329	1.019	1.294,77	3.133	2.323	1.759	1.870,22
1.800	1.872	1.407	1.079	1.342,52	3.317	2.460	1.863	1.938,05
1.900	1.976	1.485	1.138	1.390,27	3.502	2.597	1.966	2.005,89
2.000	2.080	1.563	1.198	1.438,02	3.686	2.733	2.069	2.073,72
2.200	2.288	1.720	1.318	1.533,52	4.055	3.007	2.276	2.209,39
2.400	2.496	1.876	1.438	1.629,02	4.423	3.280	2.483	2.345,05
2.600	2.704	2.032	1.558	1.724,51	4.792	3.553	2.690	2.480,72
2.800	2.912	2.189	1.678	1.820,01	5.160	3.827	2.897	2.616,38
3.000	3.120	2.345	1.798	1.915,51	5.529	4.100	3.104	2.752,05
3.200	3.328	2.501	1.917	2.011,01	5.898	4.373	3.311	2.887,72
3.400	3.536	2.657	2.037	2.106,51	6.266	4.647	3.518	3.023,38
3.600	3.744	2.814	2.157	2.202,00	6.635	4.920	3.725	3.159,05
3.800	3.952	2.970	2.277	2.297,50	7.003	5.193	3.932	3.294,71
4.000	4.160	3.126	2.397	2.393,00	7.372	5.467	4.139	3.430,38
4.200	4.368	3.283	2.517	2.488,50	7.741	5.740	4.346	3.566,05
4.400	4.576	3.439	2.636	2.584,00	8.109	6.013	4.553	3.701,71
4.600	4.784	3.595	2.756	2.679,49	8.478	6.287	4.760	3.837,38
4.800	4.992	3.752	2.876	2.774,99	8.846	6.560	4.967	3.973,04
5.000	5.200	3.908	2.996	2.870,49	9.215	6.833	5.174	4.108,71
5.200	5.408	4.064	3.116	2.965,99	9.584	7.107	5.381	4.244,38
5.400	5.616	4.221	3.236	3.061,49	9.952	7.380	5.588	4.380,04
5.600	5.824	4.377	3.355	3.156,98	10.321	7.653	5.795	4.515,71
5.800	6.032	4.533	3.475	3.252,48	10.689	7.927	6.001	4.651,37
6.000	6.240	4.690	3.595	3.347,98	11.058	8.200	6.208	4.787,04

Precios para color blanco estándar RAL 9016.

Precios para carta de colores Zehnder +25%. Otros colores, consultar.



# Zehnder Nova

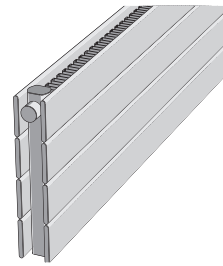
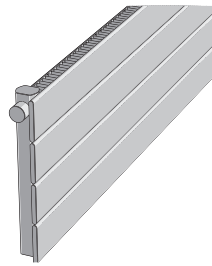
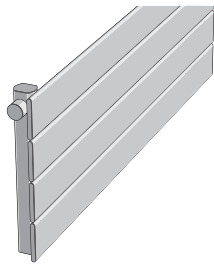
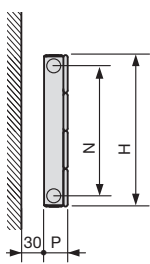

MODELO	NH 70	NHL 70/56	NHLH 70/56
Altura H	709 mm	709 mm	709 mm
Entre ejes N	669 mm	669 mm	669 mm
Profundidad P	45 mm	60 mm	53 mm
Exponente n	1,25	1,29	1,33

Recuerde pedir el Pack de Conexión

Longitud L mm	NH 70				NHL 70/56				NHLH 70/56			
	Emisión EN 442 75/65/20 ΔT 50K W	Emisión Caldera condens. ΔT 40K W	Emisión Bomba de calor ΔT 32,5K W	Blanco RAL 9016 PVP €	Emisión EN 442 75/65/20 ΔT 50K W	Emisión Caldera condens. ΔT 40K W	Emisión Bomba de calor ΔT 32,5K W	Blanco RAL 9016 PVP €	Emisión EN 442 75/65/20 ΔT 50K W	Emisión Caldera condens. ΔT 40K W	Emisión Bomba de calor ΔT 32,5K W	Blanco RAL 9016 PVP €
500	368	278	215	514,60	575	431	330	549,06	672	499	379	993,74
600	442	334	258	555,56	689	517	395	584,26	806	599	455	1.059,37
700	515	390	301	596,52	804	603	461	619,46	941	699	530	1.125,00
800	589	445	344	637,49	919	689	527	654,66	1.075	799	606	1.190,63
900	662	501	387	678,45	1.034	775	593	689,87	1.210	899	682	1.256,27
1.000	736	557	430	719,41	1.149	862	659	725,07	1.344	999	758	1.321,90
1.100	810	613	473	760,37	1.264	948	725	760,27	1.478	1.099	834	1.387,53
1.200	883	668	515	801,33	1.379	1.034	791	795,48	1.613	1.199	909	1.453,17
1.300	957	724	558	842,30	1.494	1.120	857	830,68	1.747	1.299	985	1.518,80
1.400	1.030	780	601	883,26	1.609	1.206	923	865,88	1.882	1.398	1.061	1.584,43
1.500	1.104	835	644	924,22	1.724	1.292	989	901,09	2.016	1.498	1.137	1.650,07
1.600	1.178	891	687	965,18	1.838	1.379	1.055	936,29	2.150	1.598	1.213	1.715,70
1.700	1.251	947	730	1.006,14	1.953	1.465	1.121	971,49	2.285	1.698	1.288	1.781,33
1.800	1.325	1.002	773	1.047,11	2.068	1.551	1.186	1.006,69	2.419	1.798	1.364	1.846,96
1.900	1.398	1.058	816	1.088,07	2.183	1.637	1.252	1.041,90	2.554	1.898	1.440	1.912,60
2.000	1.472	1.114	859	1.129,03	2.298	1.723	1.318	1.077,10	2.688	1.998	1.516	1.978,23
2.200	1.619	1.225	945	1.210,95	2.528	1.896	1.450	1.147,51	2.957	2.198	1.667	2.109,50
2.400	1.766	1.336	1.031	1.292,88	2.758	2.068	1.582	1.217,91	3.226	2.397	1.819	2.240,76
2.600	1.914	1.448	1.117	1.374,80	2.987	2.240	1.714	1.288,32	3.494	2.597	1.970	2.372,03
2.800	2.061	1.559	1.203	1.456,73	3.217	2.412	1.846	1.358,72	3.763	2.797	2.122	2.503,29
3.000	2.208	1.671	1.289	1.538,65	3.447	2.585	1.977	1.429,13	4.032	2.997	2.274	2.634,56
3.200	2.355	1.782	1.375	1.620,57	3.677	2.757	2.109	1.499,54	4.301	3.196	2.425	2.765,83
3.400	2.502	1.893	1.460	1.702,50	3.907	2.929	2.241	1.569,94	4.570	3.396	2.577	2.897,09
3.600	2.650	2.005	1.546	1.784,42	4.136	3.102	2.373	1.640,35	4.838	3.596	2.728	3.028,36
3.800	2.797	2.116	1.632	1.866,35	4.366	3.274	2.505	1.710,75	5.107	3.796	2.880	3.159,62
4.000	2.944	2.227	1.718	1.948,27	4.596	3.446	2.637	1.781,16	5.376	3.995	3.031	3.290,89
4.200	3.091	2.339	1.804	2.030,19	4.826	3.619	2.768	1.851,57	5.645	4.195	3.183	3.422,16
4.400	3.238	2.450	1.890	2.112,12	5.056	3.791	2.900	1.921,97	5.914	4.395	3.334	3.553,42
4.600	3.386	2.562	1.976	2.194,04	5.285	3.963	3.032	1.992,38	6.182	4.595	3.486	3.684,69
4.800	3.533	2.673	2.062	2.275,97	5.515	4.136	3.164	2.062,78	6.451	4.795	3.638	3.815,95
5.000	3.680	2.784	2.148	2.357,89	5.745	4.308	3.296	2.133,19	6.720	4.994	3.789	3.947,22
5.200	3.827	2.896	2.234	2.439,81	5.975	4.480	3.428	2.203,60	6.989	5.194	3.941	4.078,49
5.400	3.974	3.007	2.320	2.521,74	6.205	4.653	3.559	2.274,00	7.258	5.394	4.092	4.209,75
5.600	4.122	3.118	2.406	2.603,66	6.434	4.825	3.691	2.344,41	7.526	5.594	4.244	4.341,02
5.800	4.269	3.230	2.491	2.685,59	6.664	4.997	3.823	2.414,81	7.795	5.793	4.395	4.472,28
6.000	4.416	3.341	2.577	2.767,51	6.894	5.170	3.955	2.485,22	8.064	5.993	4.547	4.603,55

Precios para color blanco estándar RAL 9016.

Precios para carta de colores Zehnder +25%. Otros colores, consultar.



# Zehnder Nova

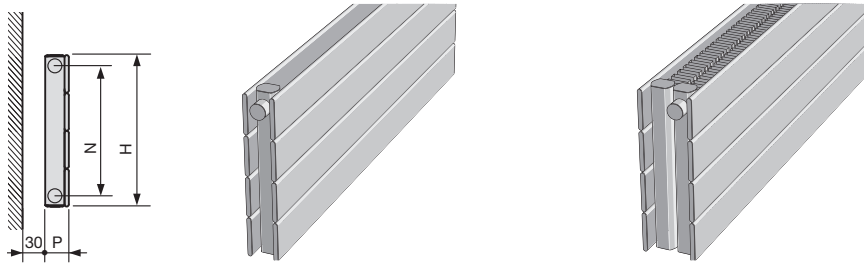

MODELO	NHH 70	NLLH 70/56
Altura H	709 mm	709 mm
Entre ejes N	669 mm	669 mm
Profundidad P	53 mm	92 mm
Exponente n	1,28	1,34

Recuerde pedir el Pack de Conexión

Longitud L mm	Emisión EN 442 75/65/20 ΔT 50K W	Emisión Caldera condens. ΔT 40K W	Emisión Bomba de calor ΔT 32,5K W	Blanco RAL 9016 PVP €	Emisión EN 442 75/65/20 ΔT 50K W	Emisión Caldera condens. ΔT 40K W	Emisión Bomba de calor ΔT 32,5K W	Blanco RAL 9016 PVP €
500	573	431	330	786,12	968	718	543	1.120,58
600	688	517	396	838,78	1.162	861	652	1.193,32
700	802	603	462	891,44	1.355	1.005	761	1.266,07
800	917	689	528	944,10	1.549	1.149	870	1.338,81
900	1.031	775	594	996,76	1.742	1.292	978	1.411,56
1.000	1.146	861	660	1.049,42	1.936	1.436	1.087	1.484,30
1.100	1.261	947	726	1.102,08	2.130	1.579	1.196	1.557,04
1.200	1.375	1.034	792	1.154,74	2.323	1.723	1.304	1.629,79
1.300	1.490	1.120	858	1.207,40	2.517	1.866	1.413	1.702,53
1.400	1.604	1.206	924	1.260,06	2.710	2.010	1.522	1.775,28
1.500	1.719	1.292	990	1.312,72	2.904	2.153	1.630	1.848,02
1.600	1.834	1.378	1.056	1.365,38	3.098	2.297	1.739	1.920,76
1.700	1.948	1.464	1.122	1.418,04	3.291	2.441	1.848	1.993,51
1.800	2.063	1.550	1.188	1.470,70	3.485	2.584	1.957	2.066,25
1.900	2.177	1.636	1.254	1.523,36	3.678	2.728	2.065	2.139,00
2.000	2.292	1.723	1.321	1.576,02	3.872	2.871	2.174	2.211,74
2.200	2.521	1.895	1.453	1.681,34	4.259	3.158	2.391	2.357,23
2.400	2.750	2.067	1.585	1.786,66	4.646	3.446	2.609	2.502,72
2.600	2.980	2.239	1.717	1.891,98	5.034	3.733	2.826	2.648,20
2.800	3.209	2.412	1.849	1.997,30	5.421	4.020	3.043	2.793,69
3.000	3.438	2.584	1.981	2.102,62	5.808	4.307	3.261	2.939,18
3.200	3.667	2.756	2.113	2.207,94	6.195	4.594	3.478	3.084,67
3.400	3.896	2.928	2.245	2.313,26	6.582	4.881	3.696	3.230,16
3.600	4.126	3.101	2.377	2.418,58	6.970	5.168	3.913	3.375,64
3.800	4.355	3.273	2.509	2.523,90	7.357	5.455	4.130	3.521,13
4.000	4.584	3.445	2.641	2.629,22	7.744	5.743	4.348	3.666,62
4.200	4.813	3.617	2.773	2.734,54	8.131	6.030	4.565	3.812,11
4.400	5.042	3.790	2.905	2.839,86	8.518	6.317	4.783	3.957,60
4.600	5.272	3.962	3.037	2.945,18	8.906	6.604	5.000	4.103,08
4.800	5.501	4.134	3.169	3.050,50	9.293	6.891	5.217	4.248,57
5.000	5.730	4.306	3.301	3.155,82	9.680	7.178	5.435	4.394,06
5.200	5.959	4.479	3.433	3.261,14	10.067	7.465	5.652	4.539,55
5.400	6.188	4.651	3.565	3.366,46	10.454	7.752	5.870	4.685,04
5.600	6.418	4.823	3.697	3.471,78	10.842	8.040	6.087	4.830,52
5.800	6.647	4.995	3.829	3.577,10	11.229	8.327	6.304	4.976,01
6.000	6.876	5.168	3.962	3.682,42	11.616	8.614	6.522	5.121,50

Precios para color blanco estándar RAL 9016.  
Precios para carta de colores Zehnder +25%. Otros colores, consultar.



# Zehnder Nova

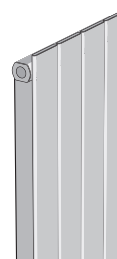
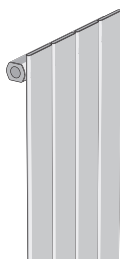
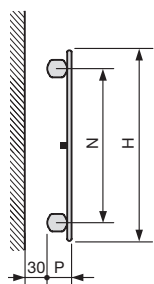

MODELO	NV 60	NVL 60
Altura H	600 mm	600 mm
Entre ejes N	532 mm	532 mm
Profundidad P	45 mm	58 mm
Exponente n	1,27	1,28

Recuerde pedir el Pack de Conexión

Elementos	Longitud L		Emisión EN 442 75/65/20 ΔT 50K W	Emisión Caldera condens. ΔT 40K W	Emisión Bomba de calor ΔT 32,5K W	Blanco RAL 9016 PVP €	Emisión EN 442 75/65/20 ΔT 50K W	Emisión Caldera condens. ΔT 40K W	Emisión Bomba de calor ΔT 32,5K W	Blanco RAL 9016 PVP €
	Nominal mm	Real mm								
2	140	141	92	69	53	192,75	142	107	82	337,89
3	210	212	138	104	80	227,86	213	160	123	372,08
4	280	283	184	139	106	262,97	284	213	164	406,27
5	350	354	230	173	133	298,08	355	267	205	440,46
6	420	425	276	208	160	333,19	426	320	245	474,65
7	490	496	322	243	186	368,30	497	374	286	508,84
8	560	567	368	277	213	403,41	568	427	327	543,03
9	630	638	414	312	240	438,52	639	480	368	577,22
10	700	709	460	346	266	473,63	710	534	409	611,41
11	770	780	506	381	293	508,74	781	587	450	645,60
12	840	851	552	416	319	543,85	852	640	491	679,79
13	910	922	598	450	346	578,96	923	694	532	713,98
14	980	993	644	485	373	614,07	994	747	573	748,17
15	1.050	1.064	690	520	399	649,18	1.065	800	614	782,36
16	1.120	1.135	736	554	426	684,29	1.136	854	654	816,55
17	1.190	1.206	782	589	452	719,40	1.207	907	695	850,74
18	1.260	1.277	828	624	479	754,51	1.278	960	736	884,93
19	1.330	1.348	874	658	506	789,62	1.349	1.014	777	919,12
20	1.400	1.419	920	693	532	824,73	1.420	1.067	818	953,31
21	1.470	1.490	966	728	559	859,84	1.491	1.121	859	987,50
22	1.540	1.561	1.012	762	586	894,95	1.562	1.174	900	1.021,69
23	1.610	1.632	1.058	797	612	930,06	1.633	1.227	941	1.055,88
24	1.680	1.703	1.104	832	639	965,17	1.704	1.281	982	1.090,07

Precios para color blanco estándar RAL 9016.

Precios para carta de colores Zehnder +25%. Otros colores, consultar.



# Zehnder Nova

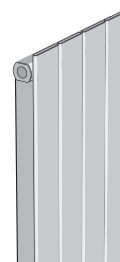
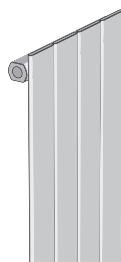
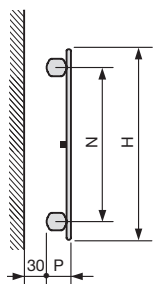

MODELO	NV 80	NVL 80
Altura H	800 mm	800 mm
Entre ejes N	732 mm	732 mm
Profundidad P	45 mm	58 mm
Exponente n	1,27	1,29

Recuerde pedir el Pack de Conexión

Elementos	Longitud L		Emisión EN 442 75/65/20 ΔT 50K W	Emisión Caldera condens. ΔT 40K W	Emisión Bomba de calor ΔT 32,5K W	Blanco RAL 9016 PVP €	Emisión EN 442 75/65/20 ΔT 50K W	Emisión Caldera condens. ΔT 40K W	Emisión Bomba de calor ΔT 32,5K W	Blanco RAL 9016 PVP €
	Nominal mm	Real mm								
2	140	141	120	90	69	206,27	176	132	101	376,21
3	210	212	180	136	104	246,53	264	198	151	415,55
4	280	283	240	181	139	286,79	352	264	202	454,89
5	350	354	300	226	174	327,05	440	330	252	494,23
6	420	425	360	271	208	367,31	528	396	303	533,57
7	490	496	420	316	243	407,57	616	462	353	572,91
8	560	567	480	362	278	447,83	704	528	404	612,25
9	630	638	540	407	312	488,09	792	594	454	651,59
10	700	709	600	452	347	528,35	880	660	505	690,93
11	770	780	660	497	382	568,61	968	726	555	730,27
12	840	851	720	542	417	608,87	1.056	792	606	769,61
13	910	922	780	588	451	649,13	1.144	858	656	808,95
14	980	993	840	633	486	689,39	1.232	924	707	848,29
15	1.050	1.064	900	678	521	729,65	1.320	990	757	887,63
16	1.120	1.135	960	723	555	769,91	1.408	1.056	808	926,97
17	1.190	1.206	1.020	768	590	810,17	1.496	1.122	858	966,31
18	1.260	1.277	1.080	813	625	850,43	1.584	1.188	909	1.005,65
19	1.330	1.348	1.140	859	660	890,69	1.672	1.254	959	1.044,99
20	1.400	1.419	1.200	904	694	930,95	1.760	1.320	1.010	1.084,33
21	1.470	1.490	1.260	949	729	971,21	1.848	1.386	1.060	1.123,67
22	1.540	1.561	1.320	994	764	1.011,47	1.936	1.452	1.111	1.163,01
23	1.610	1.632	1.380	1.039	799	1.051,73	2.024	1.518	1.161	1.202,35
24	1.680	1.703	1.440	1.085	833	1.091,99	2.112	1.584	1.212	1.241,69

Precios para color blanco estándar RAL 9016.

Precios para carta de colores Zehnder +25%. Otros colores, consultar.



# Zehnder Nova

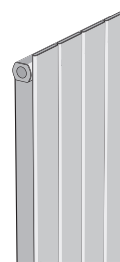
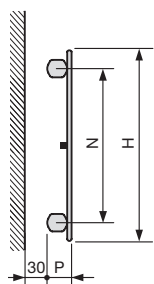

MODELO	NV 100	NVL 100
Altura H	1.000 mm	1.000 mm
Entre ejes N	932 mm	932 mm
Profundidad P	45 mm	58 mm
Exponente n	1,27	1,29

Recuerde pedir el Pack de Conexión

Elementos	Longitud L		Emisión EN 442 75/65/20 ΔT 50K W	Emisión Caldera condens. ΔT 40K W	Emisión Bomba de calor ΔT 32,5K W	Blanco RAL 9016 PVP €	Emisión EN 442 75/65/20 ΔT 50K W	Emisión Caldera condens. ΔT 40K W	Emisión Bomba de calor ΔT 32,5K W	Blanco RAL 9016 PVP €
	Nominal mm	Real mm								
2	140	141	148	111	86	219,71	210	157	120	414,50
3	210	212	222	167	128	265,12	315	236	181	458,98
4	280	283	296	223	171	310,53	420	315	241	503,46
5	350	354	370	279	214	355,94	525	394	301	547,94
6	420	425	444	334	257	401,35	630	472	361	592,42
7	490	496	518	390	300	446,76	735	551	422	636,90
8	560	567	592	446	343	492,17	840	630	482	681,38
9	630	638	666	502	385	537,58	945	709	542	725,86
10	700	709	740	557	428	582,99	1.050	787	602	770,34
11	770	780	814	613	471	628,40	1.155	866	663	814,82
12	840	851	888	669	514	673,81	1.260	945	723	859,30
13	910	922	962	725	557	719,22	1.365	1.024	783	903,78
14	980	993	1.036	780	599	764,63	1.470	1.102	843	948,26
15	1.050	1.064	1.110	836	642	810,04	1.575	1.181	904	992,74
16	1.120	1.135	1.184	892	685	855,45	1.680	1.260	964	1.037,22
17	1.190	1.206	1.258	948	728	900,86	1.785	1.339	1.024	1.081,70
18	1.260	1.277	1.332	1.003	771	946,27	1.890	1.417	1.084	1.126,18
19	1.330	1.348	1.406	1.059	814	991,68	1.995	1.496	1.144	1.170,66
20	1.400	1.419	1.480	1.115	856	1.037,09	2.100	1.575	1.205	1.215,14
21	1.470	1.490	1.554	1.171	899	1.082,50	2.205	1.653	1.265	1.259,62
22	1.540	1.561	1.628	1.226	942	1.127,91	2.310	1.732	1.325	1.304,10
23	1.610	1.632	1.702	1.282	985	1.173,32	2.415	1.811	1.385	1.348,58
24	1.680	1.703	1.776	1.338	1.028	1.218,73	2.520	1.890	1.446	1.393,06

Precios para color blanco estándar RAL 9016.

Precios para carta de colores Zehnder +25%. Otros colores, consultar.



# Zehnder Nova

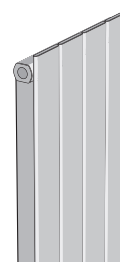
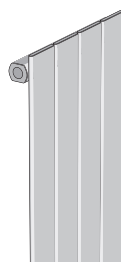
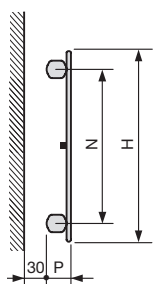

MODELO	NV 120	NVL 120
Altura H	1.200 mm	1.200 mm
Entre ejes N	1.132 mm	1.132 mm
Profundidad P	45 mm	58 mm
Exponente n	1,28	1,30

Recuerde pedir el Pack de Conexión

Elementos	Longitud L		Emisión EN 442 75/65/20 ΔT 50K W	Emisión Caldera condens. ΔT 40K W	Emisión Bomba de calor ΔT 32,5K W	Blanco RAL 9016 PVP €	Emisión EN 442 75/65/20 ΔT 50K W	Emisión Caldera condens. ΔT 40K W	Emisión Bomba de calor ΔT 32,5K W	Blanco RAL 9016 PVP €
	Nominal mm	Real mm								
2	140	141	176	132	101	233,27	242	181	138	452,82
3	210	212	264	198	152	283,82	363	272	207	502,45
4	280	283	352	265	203	334,37	484	362	276	552,08
5	350	354	440	331	254	384,92	605	453	346	601,71
6	420	425	528	397	304	435,47	726	543	415	651,34
7	490	496	616	463	355	486,02	847	634	484	700,97
8	560	567	704	529	406	536,57	968	724	553	750,60
9	630	638	792	595	456	587,12	1.089	815	622	800,23
10	700	709	880	661	507	637,67	1.210	905	691	849,86
11	770	780	968	727	558	688,22	1.331	996	760	899,49
12	840	851	1.056	794	608	738,77	1.452	1.086	829	949,12
13	910	922	1.144	860	659	789,32	1.573	1.177	898	998,75
14	980	993	1.232	926	710	839,87	1.694	1.267	968	1.048,38
15	1.050	1.064	1.320	992	761	890,42	1.815	1.358	1.037	1.098,01
16	1.120	1.135	1.408	1.058	811	940,97	1.936	1.449	1.106	1.147,64
17	1.190	1.206	1.496	1.124	862	991,52	2.057	1.539	1.175	1.197,27
18	1.260	1.277	1.584	1.190	913	1.042,07	2.178	1.630	1.244	1.246,90
19	1.330	1.348	1.672	1.257	963	1.092,62	2.299	1.720	1.313	1.296,53
20	1.400	1.419	1.760	1.323	1.014	1.143,17	2.420	1.811	1.382	1.346,16
21	1.470	1.490	1.848	1.389	1.065	1.193,72	2.541	1.901	1.451	1.395,79
22	1.540	1.561	1.936	1.455	1.115	1.244,27	2.662	1.992	1.521	1.445,42
23	1.610	1.632	2.024	1.521	1.166	1.294,82	2.783	2.082	1.590	1.495,05
24	1.680	1.703	2.112	1.587	1.217	1.345,37	2.904	2.173	1.659	1.544,68

Precios para color blanco estándar RAL 9016.

Precios para carta de colores Zehnder +25%. Otros colores, consultar.



# Zehnder Nova

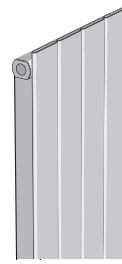
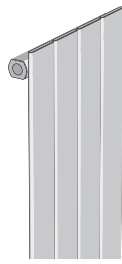
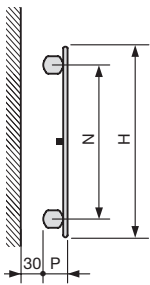

MODELO	NV 140	NVL 140
Altura H	1.400 mm	1.400 mm
Entre ejes N	1.332 mm	1.332 mm
Profundidad P	45 mm	58 mm
Exponente n	1,29	1,31

Recuerde pedir el Pack de Conexión

Elementos	Longitud L		Emisión EN 442 75/65/20 ΔT 50K W	Emisión Caldera condens. ΔT 40K W	Emisión Bomba de calor ΔT 32,5K W	Blanco RAL 9016 PVP €	Emisión EN 442 75/65/20 ΔT 50K W	Emisión Caldera condens. ΔT 40K W	Emisión Bomba de calor ΔT 32,5K W	Blanco RAL 9016 PVP €
	Nominal mm	Real mm								
2	140	141	204	153	117	246,79	274	205	156	491,17
3	210	212	306	229	176	302,50	411	307	234	545,97
4	280	283	408	306	234	358,21	548	409	312	600,77
5	350	354	510	382	293	413,92	685	511	390	655,57
6	420	425	612	459	351	469,63	822	614	468	710,37
7	490	496	714	535	410	525,34	959	716	545	765,17
8	560	567	816	612	468	581,05	1.096	818	623	819,97
9	630	638	918	688	527	636,76	1.233	920	701	874,77
10	700	709	1.020	765	585	692,47	1.370	1.023	779	929,57
11	770	780	1.122	841	644	748,18	1.507	1.125	857	984,37
12	840	851	1.224	918	702	803,89	1.644	1.227	935	1.039,17
13	910	922	1.326	994	761	859,60	1.781	1.330	1.013	1.093,97
14	980	993	1.428	1.071	819	915,31	1.918	1.432	1.091	1.148,77
15	1.050	1.064	1.530	1.147	878	971,02	2.055	1.534	1.169	1.203,57
16	1.120	1.135	1.632	1.224	936	1.026,73	2.192	1.636	1.247	1.258,37
17	1.190	1.206	1.734	1.300	995	1.082,44	2.329	1.739	1.325	1.313,17
18	1.260	1.277	1.836	1.377	1.053	1.138,15	2.466	1.841	1.403	1.367,97
19	1.330	1.348	1.938	1.453	1.112	1.193,86	2.603	1.943	1.480	1.422,77
20	1.400	1.419	2.040	1.530	1.170	1.249,57	2.740	2.045	1.558	1.477,57
21	1.470	1.490	2.142	1.606	1.229	1.305,28	2.877	2.148	1.636	1.532,37
22	1.540	1.561	2.244	1.683	1.287	1.360,99	3.014	2.250	1.714	1.587,17
23	1.610	1.632	2.346	1.759	1.346	1.416,70	3.151	2.352	1.792	1.641,97
24	1.680	1.703	2.448	1.836	1.404	1.472,41	3.288	2.455	1.870	1.696,77

Precios para color blanco estándar RAL 9016.

Precios para carta de colores Zehnder +25%. Otros colores, consultar.



# Zehnder Nova

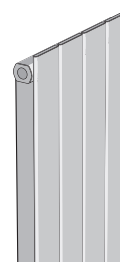
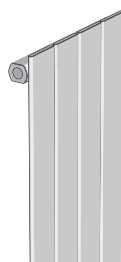
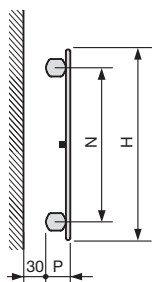

MODELO	NV 160	NVL 160
Altura H	1.600 mm	1.600 mm
Entre ejes N	1.532 mm	1.532 mm
Profundidad P	45 mm	58 mm
Exponente n	1,30	1,32

Recuerde pedir el Pack de Conexión

Elementos	Longitud L		Emisión EN 442 75/65/20 ΔT 50K W	Emisión Caldera condens. ΔT 40K W	Emisión Bomba de calor ΔT 32,5K W	Blanco RAL 9016 PVP €	Emisión EN 442 75/65/20 ΔT 50K W	Emisión Caldera condens. ΔT 40K W	Emisión Bomba de calor ΔT 32,5K W	Blanco RAL 9016 PVP €
	Nominal mm	Real mm								
2	140	141	232	174	133	260,24	306	228	173	529,44
3	210	212	348	260	199	321,10	459	342	260	589,36
4	280	283	464	347	265	381,96	612	456	347	649,28
5	350	354	580	434	331	442,82	765	570	433	709,20
6	420	425	696	521	398	503,68	918	684	520	769,12
7	490	496	812	608	464	564,54	1.071	798	607	829,04
8	560	567	928	694	530	625,40	1.224	912	693	888,96
9	630	638	1.044	781	596	686,26	1.377	1.026	780	948,88
10	700	709	1.160	868	663	747,12	1.530	1.140	866	1.008,80
11	770	780	1.276	955	729	807,98	1.683	1.254	953	1.068,72
12	840	851	1.392	1.041	795	868,84	1.836	1.368	1.040	1.128,64
13	910	922	1.508	1.128	861	929,70	1.989	1.482	1.126	1.188,56
14	980	993	1.624	1.215	928	990,56	2.142	1.596	1.213	1.248,48
15	1.050	1.064	1.740	1.302	994	1.051,42	2.295	1.709	1.300	1.308,40
16	1.120	1.135	1.856	1.389	1.060	1.112,28	2.448	1.823	1.386	1.368,32
17	1.190	1.206	1.972	1.475	1.126	1.173,14	2.601	1.937	1.473	1.428,24
18	1.260	1.277	2.088	1.562	1.193	1.234,00	2.754	2.051	1.560	1.488,16
19	1.330	1.348	2.204	1.649	1.259	1.294,86	2.907	2.165	1.646	1.548,08
20	1.400	1.419	2.320	1.736	1.325	1.355,72	3.060	2.279	1.733	1.608,00
21	1.470	1.490	2.436	1.823	1.391	1.416,58	3.213	2.393	1.820	1.667,92
22	1.540	1.561	2.552	1.909	1.458	1.477,44	3.366	2.507	1.906	1.727,84
23	1.610	1.632	2.668	1.996	1.524	1.538,30	3.519	2.621	1.993	1.787,76
24	1.680	1.703	2.784	2.083	1.590	1.599,16	3.672	2.735	2.079	1.847,68

Precios para color blanco estándar RAL 9016.  
Precios para carta de colores Zehnder +25%. Otros colores, consultar.



# Zehnder Nova

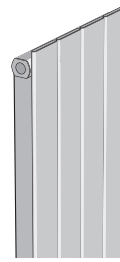
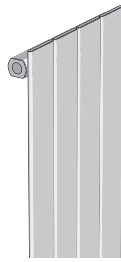
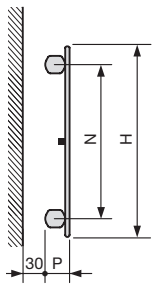

MODELO	NV 180	NVL 180
Altura H	1.800 mm	1.800 mm
Entre ejes N	1.732 mm	1.732 mm
Profundidad P	45 mm	58 mm
Exponente n	1,31	1,33

Recuerde pedir el Pack de Conexión

Elementos	Longitud L		Emisión EN 442 75/65/20 ΔT 50K W	Emisión Caldera condens. ΔT 40K W	Emisión Bomba de calor ΔT 32,5K W	Blanco RAL 9016 PVP €	Emisión EN 442 75/65/20 ΔT 50K W	Emisión Caldera condens. ΔT 40K W	Emisión Bomba de calor ΔT 32,5K W	Blanco RAL 9016 PVP €
	Nominal mm	Real mm								
2	140	141	260	194	148	273,73	338	251	191	554,61
3	210	212	390	291	222	339,72	507	377	286	619,68
4	280	283	520	388	296	405,71	676	502	381	684,75
5	350	354	650	485	370	471,70	845	628	476	749,82
6	420	425	780	582	444	537,69	1.014	754	572	814,89
7	490	496	910	679	518	603,68	1.183	879	667	879,96
8	560	567	1.040	776	591	669,67	1.352	1.005	762	945,03
9	630	638	1.170	873	665	735,66	1.521	1.130	858	1.010,10
10	700	709	1.300	970	739	801,65	1.690	1.256	953	1.075,17
11	770	780	1.430	1.068	813	867,64	1.859	1.382	1.048	1.140,24
12	840	851	1.560	1.165	887	933,63	2.028	1.507	1.144	1.205,31
13	910	922	1.690	1.262	961	999,62	2.197	1.633	1.239	1.270,38
14	980	993	1.820	1.359	1.035	1.065,61	2.366	1.758	1.334	1.335,45
15	1.050	1.064	1.950	1.456	1.109	1.131,60	2.535	1.884	1.429	1.400,52
16	1.120	1.135	2.080	1.553	1.183	1.197,59	2.704	2.010	1.525	1.465,59
17	1.190	1.206	2.210	1.650	1.257	1.263,58	2.873	2.135	1.620	1.530,66
18	1.260	1.277	2.340	1.747	1.331	1.329,57	3.042	2.261	1.715	1.595,73
19	1.330	1.348	2.470	1.844	1.405	1.395,56	3.211	2.386	1.811	1.660,80
20	1.400	1.419	2.600	1.941	1.479	1.461,55	3.380	2.512	1.906	1.725,87
21	1.470	1.490	2.730	2.038	1.553	1.527,54	3.549	2.638	2.001	1.790,94
22	1.540	1.561	2.860	2.135	1.627	1.593,53	3.718	2.763	2.096	1.856,01
23	1.610	1.632	2.990	2.232	1.701	1.659,52	3.887	2.889	2.192	1.921,08
24	1.680	1.703	3.120	2.329	1.774	1.725,51	4.056	3.014	2.287	1.986,15

Precios para color blanco estándar RAL 9016.

Precios para carta de colores Zehnder +25%. Otros colores, consultar.



# Zehnder Nova

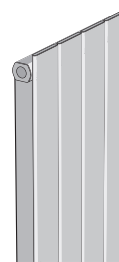
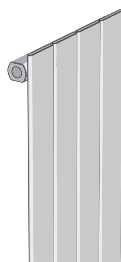
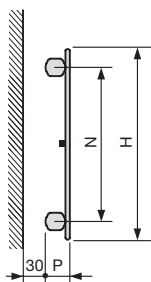

MODELO	NV 200	NVL 200
Altura H	2.000 mm	2.000 mm
Entre ejes N	1.932 mm	1.932 mm
Profundidad P	45 mm	58 mm
Exponente n	1,31	1,32

Recuerde pedir el Pack de Conexión

Elementos	Longitud L		Emisión EN 442 75/65/20 ΔT 50K W	Emisión Caldera condens. ΔT 40K W	Emisión Bomba de calor ΔT 32,5K W	Blanco RAL 9016 PVP €	Emisión EN 442 75/65/20 ΔT 50K W	Emisión Caldera condens. ΔT 40K W	Emisión Bomba de calor ΔT 32,5K W	Blanco RAL 9016 PVP €
	Nominal mm	Real mm								
2	140	141	290	216	165	287,27	370	276	210	586,57
3	210	212	435	325	247	358,42	555	413	314	663,15
4	280	283	580	433	330	429,57	740	551	419	739,73
5	350	354	725	541	412	500,72	925	689	524	816,31
6	420	425	870	649	495	571,87	1.110	827	629	892,89
7	490	496	1.015	758	577	643,02	1.295	965	733	969,47
8	560	567	1.160	866	660	714,17	1.480	1.102	838	1.046,05
9	630	638	1.305	974	742	785,32	1.665	1.240	943	1.122,63
10	700	709	1.450	1.082	825	856,47	1.850	1.378	1.048	1.199,21
11	770	780	1.595	1.191	907	927,62	2.035	1.516	1.152	1.275,79
12	840	851	1.740	1.299	990	998,77	2.220	1.654	1.257	1.352,37
13	910	922	1.885	1.407	1.072	1.069,92	2.405	1.791	1.362	1.428,95
14	980	993	2.030	1.515	1.155	1.141,07	2.590	1.929	1.467	1.505,53
15	1.050	1.064	2.175	1.624	1.237	1.212,22	2.775	2.067	1.571	1.582,11
16	1.120	1.135	2.320	1.732	1.319	1.283,37	2.960	2.205	1.676	1.658,69
17	1.190	1.206	2.465	1.840	1.402	1.354,52	3.145	2.343	1.781	1.735,27
18	1.260	1.277	2.610	1.948	1.484	1.425,67	3.330	2.480	1.886	1.811,85
19	1.330	1.348	2.755	2.057	1.567	1.496,82	3.515	2.618	1.991	1.888,43
20	1.400	1.419	2.900	2.165	1.649	1.567,97	3.700	2.756	2.095	1.965,01
21	1.470	1.490	3.045	2.273	1.732	1.639,12	3.885	2.894	2.200	2.041,59
22	1.540	1.561	3.190	2.381	1.814	1.710,27	4.070	3.032	2.305	2.118,17
23	1.610	1.632	3.335	2.490	1.897	1.781,42	4.255	3.169	2.410	2.194,75
24	1.680	1.703	3.480	2.598	1.979	1.852,57	4.440	3.307	2.514	2.271,33

Precios para color blanco estándar RAL 9016.  
Precios para carta de colores Zehnder +25%. Otros colores, consultar.





# Zehnder Nova

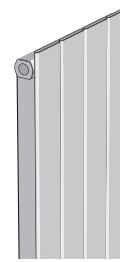
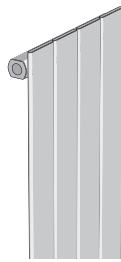
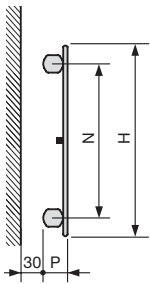

MODELO	NV 220	NVL 220
Altura H	2.200 mm	2.200 mm
Entre ejes N	2.132 mm	2.132 mm
Profundidad P	45 mm	58 mm
Exponente n	1,31	1,31

Recuerde pedir el Pack de Conexión

Elementos	Longitud L		Emisión EN 442 75/65/20 ΔT 50K W	Emisión Caldera condens. ΔT 40K W	Emisión Bomba de calor ΔT 32,5K W	Blanco RAL 9016 PVP €	Emisión EN 442 75/65/20 ΔT 50K W	Emisión Caldera condens. ΔT 40K W	Emisión Bomba de calor ΔT 32,5K W	Blanco RAL 9016 PVP €
	Nominal mm	Real mm								
2	140	141	320	239	182	300,77	402	300	229	644,37
3	210	212	480	358	273	377,08	603	450	343	719,74
4	280	283	640	478	364	453,39	804	600	457	795,11
5	350	354	800	597	455	529,70	1.005	750	572	870,48
6	420	425	960	717	546	606,01	1.206	900	686	945,85
7	490	496	1.120	836	637	682,32	1.407	1.050	800	1.021,22
8	560	567	1.280	956	728	758,63	1.608	1.200	915	1.096,59
9	630	638	1.440	1.075	819	834,94	1.809	1.350	1.029	1.171,96
10	700	709	1.600	1.194	910	911,25	2.010	1.501	1.143	1.247,33
11	770	780	1.760	1.314	1.001	987,56	2.211	1.651	1.257	1.322,70
12	840	851	1.920	1.433	1.092	1.063,87	2.412	1.801	1.372	1.398,07
13	910	922	2.080	1.553	1.183	1.140,18	2.613	1.951	1.486	1.473,44
14	980	993	2.240	1.672	1.274	1.216,49	2.814	2.101	1.600	1.548,81
15	1.050	1.064	2.400	1.792	1.365	1.292,80	3.015	2.251	1.715	1.624,18
16	1.120	1.135	2.560	1.911	1.456	1.369,11	3.216	2.401	1.829	1.699,55
17	1.190	1.206	2.720	2.031	1.547	1.445,42	3.417	2.551	1.943	1.774,92
18	1.260	1.277	2.880	2.150	1.638	1.521,73	3.618	2.701	2.058	1.850,29
19	1.330	1.348	3.040	2.269	1.729	1.598,04	3.819	2.851	2.172	1.925,66
20	1.400	1.419	3.200	2.389	1.820	1.674,35	4.020	3.001	2.286	2.001,03
21	1.470	1.490	3.360	2.508	1.911	1.750,66	4.221	3.151	2.401	2.076,40
22	1.540	1.561	3.520	2.628	2.002	1.826,97	4.422	3.301	2.515	2.151,77
23	1.610	1.632	3.680	2.747	2.093	1.903,28	4.623	3.451	2.629	2.227,14
24	1.680	1.703	3.840	2.867	2.184	1.979,59	4.824	3.601	2.744	2.302,51

Precios para color blanco estándar RAL 9016.

Precios para carta de colores Zehnder +25%. Otros colores, consultar.



# Zehnder Nova

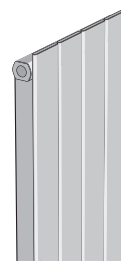
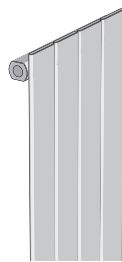
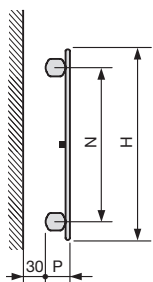

MODELO	NV 240	NVL 240
Altura H	2.400 mm	2.400 mm
Entre ejes N	2.332 mm	2.332 mm
Profundidad P	45 mm	58 mm
Exponente n	1,31	1,30

Recuerde pedir el Pack de Conexión

Elementos	Longitud L		Emisión EN 442 75/65/20 $\Delta T$ 50K W	Emisión Caldera condens. $\Delta T$ 40K W	Emisión Bomba de calor $\Delta T$ 32,5K W	Blanco RAL 9016 PVP €	Emisión EN 442 75/65/20 $\Delta T$ 50K W	Emisión Caldera condens. $\Delta T$ 40K W	Emisión Bomba de calor $\Delta T$ 32,5K W	Blanco RAL 9016 PVP €
	Nominal mm	Real mm								
2	140	141	352	263	200	314,25	434	325	248	682,73
3	210	212	528	394	300	395,70	651	487	372	763,26
4	280	283	704	526	400	477,15	868	649	496	843,79
5	350	354	880	657	500	558,60	1.085	812	620	924,32
6	420	425	1.056	788	601	640,05	1.302	974	744	1.004,85
7	490	496	1.232	920	701	721,50	1.519	1.137	868	1.085,38
8	560	567	1.408	1.051	801	802,95	1.736	1.299	992	1.165,91
9	630	638	1.584	1.183	901	884,40	1.953	1.461	1.116	1.246,44
10	700	709	1.760	1.314	1.001	965,85	2.170	1.624	1.240	1.326,97
11	770	780	1.936	1.445	1.101	1.047,30	2.387	1.786	1.363	1.407,50
12	840	851	2.112	1.577	1.201	1.128,75	2.604	1.948	1.487	1.488,03
13	910	922	2.288	1.708	1.301	1.210,20	2.821	2.111	1.611	1.568,56
14	980	993	2.464	1.839	1.401	1.291,65	3.038	2.273	1.735	1.649,09
15	1.050	1.064	2.640	1.971	1.501	1.373,10	3.255	2.435	1.859	1.729,62
16	1.120	1.135	2.816	2.102	1.602	1.454,55	3.472	2.598	1.983	1.810,15
17	1.190	1.206	2.992	2.234	1.702	1.536,00	3.689	2.760	2.107	1.890,68
18	1.260	1.277	3.168	2.365	1.802	1.617,45	3.906	2.922	2.231	1.971,21
19	1.330	1.348	3.344	2.496	1.902	1.698,90	4.123	3.085	2.355	2.051,74
20	1.400	1.419	3.520	2.628	2.002	1.780,35	4.340	3.247	2.479	2.132,27
21	1.470	1.490	3.696	2.759	2.102	1.861,80	4.557	3.410	2.603	2.212,80
22	1.540	1.561	3.872	2.891	2.202	1.943,25	4.774	3.572	2.727	2.293,33
23	1.610	1.632	4.048	3.022	2.302	2.024,70	4.991	3.734	2.851	2.373,86
24	1.680	1.703	4.224	3.153	2.402	2.106,15	5.208	3.897	2.975	2.454,39

Precios para color blanco estándar RAL 9016.

Precios para carta de colores Zehnder +25%. Otros colores, consultar.



# Zehnder Nova

## FIGURAS DE CONEXIÓN

**Conexiones Bitubo normales.** Sin suplemento de precio.

Misma mano

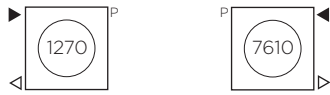

Cruzados

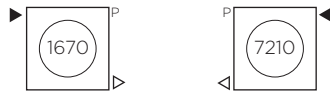

Lados opuestos

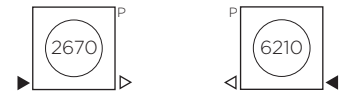

**Conexiones Bitubo especiales.** Con suplemento de precio **58,43 €.**

Desde abajo / hacia abajo

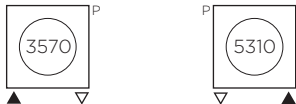

Desde arriba / hacia arriba



**Conexiones Mono-bitubo especiales.** Con suplemento de price **58,43 €.**

Racores juntos abajo\*  
Modelos horizontales

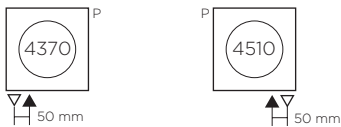

Racores juntos abajo\*\*  
Modelos verticales

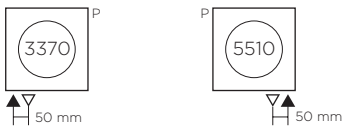

Desde abajo / hacia  
abajo

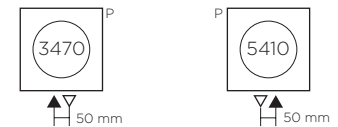

\*En los modelos horizontales la impulsión se hace por el racor interior del radiador.

\*\*En los modelos verticales la impulsión se hace por el racor exterior del radiador.

**Conexiones Monotubo.** Con suplemento de precio **58,43 €.**

Atención: respetar longitudes de las cañas.

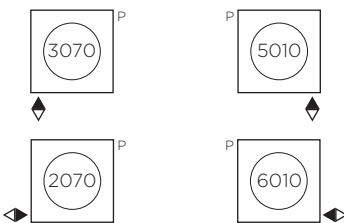

P = Purga V = Vaciado

Longitud de la caña	Radiadores verticales	Radiadores horizontales
Figuras 3070 y 5010 entrada de agua por el interior de la caña	L = 47 mm	L = 150 mm
Figuras 2070 y 6010 entrada de agua por el exterior de la caña	L = 150 mm	L = 47 mm

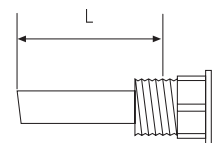

## MEDIDAS DE RACORES

Otras posiciones de racores, por ejemplo desde arriba hacia arriba, hacia atrás o adelante, pueden suministrarse bajo pedido, con suplemento de precio a consultar.

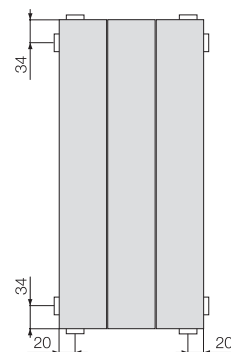
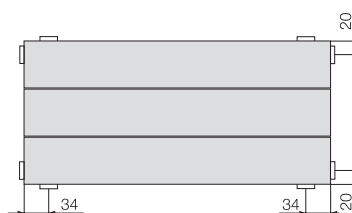

# Zehnder Nova

## SOPORTES ESTÁNDAR

### Kit de soportes

Soportes a la pared incluidos en el embalaje. En el color del radiador solo con el pedido inicial.

Cada radiador lleva el Kit con su cantidad y tipo necesario de soportes murales. (A la pared).

### Kit de soportes adicional

Al pedir un Kit de soportes adicional hay que indicar para que radiador. Diferentes radiadores usan diferentes kits.

Blanco estándar (RAL 9016)

PVP **54,67 €**

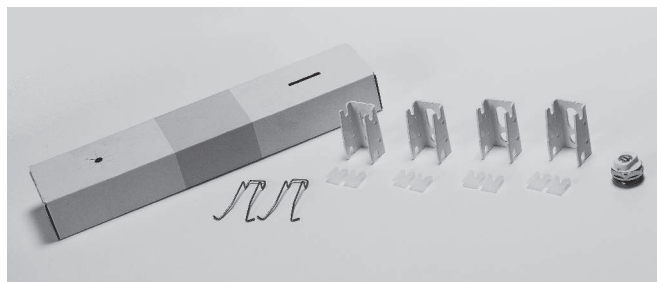

## SOPORTES SOLDADOS

Soldados en fábrica. Solo con el pedido del radiador.

Hasta modelos de 366 mm de altura sin pie, no es preciso soporte mural.

A partir de 440 mm de altura sin pie, se prevé soporte mural en la parte superior.

En el caso de pedirse soportes a medida, hay que definir las cotas A, B y C.

Recomendamos usar soportes fijos al suelo y soportes variables al techo.

El número y posición de los soportes se define en función de las medidas del radiador. Consultar.



FC

Dimensiones de la base: 100 x 50 mm.

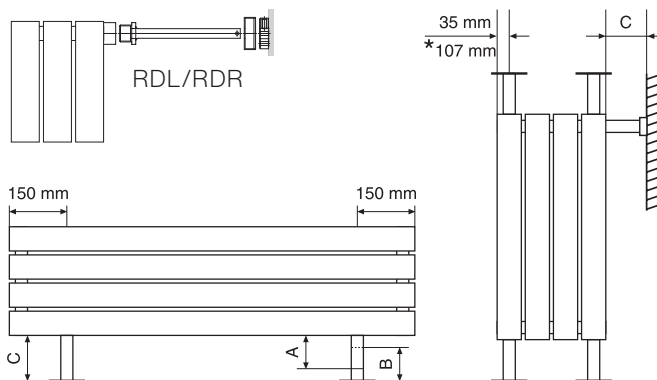

Tipo de soporte	Distancia al suelo/techo/pared		Referencia	PVP
	C mínimo mm	C máximo mm		
<b>Soportes de pie soldados</b>				
Altura regulable	150	200	FC200	<b>101,99</b>
	120	150	FC150	
A medida	A medida		FRCUS	<b>154,43</b>
<b>Soporte lateral atornillado</b>				
Regulable	60	170	RDL/RDR	<b>110,14</b>

\*A partir de 5 elementos.

# Zehnder Radiavector

El convector de diseño compacto





La mayor potencia térmica en el mínimo espacio. Zehnder Radiavector es el convector de diseño compacto creado para grandes superficies y altas exigencias de calor, como fachadas de cristal, invernaderos, pasillos amplios... Muy versátil, permite, incluso, montajes con canales disimulados en el suelo. Y se adapta a todos los ambientes.



# Zehnder Radiavector

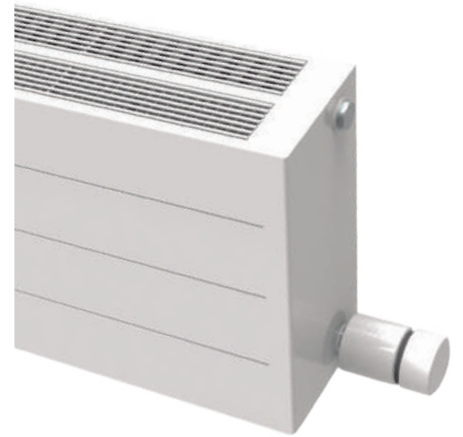

# Zehnder Radiavector

## VERSIONES Y ACABADOS

Radiador horizontal disponible en 4 alturas y 4 profundidades. (Ver página 243).

Se suministra en blanco como estándar (RAL 9016).

Disponible en los colores de la carta del Radiavector con 25% de suplemento.

Otros colores a medida pueden ser posibles. Consultar disponibilidad y precio

### Ejecuciones especiales posibles:

Las ejecuciones especiales deben ser consultadas siempre para verificar disponibilidad y precio.

Radiadores en ángulo.

Longitudes especiales.

Posición especial de racores y Figuras de Conexión distintas. (Ver página 252).

Alta presión.

Soportes de pie, de empotrar, soldados. A consultar.

## SOPORTES

Pies FMORV incluidos en el embalaje. En el color del radiador solo con el pedido inicial.

Otros soportes mural o atornillados a consultar.

### Kit de soportes FMORV adicional:

Blanco estándar (RAL 9016).

PVP **54,67 €**

## PACK DE CONEXIÓN

Incluye todas las piezas necesarias para la conexión (ver página 257).

### Bitubo:

Para la conexión estándar.

Juego de Válvula + Detentor. Tipo B.



Tipo B

### Mono-bitubo:

Válvula Mono-bitubo. Tipo O.

Solo bajo pedido. Hay que indicarlo en el pedido inicial. (Ver página 252).



Tipo O

Tipo de válvula	Acabado	Regulación manual PVP €	Regulación termostática PVP €
Todos los tipos de válvulas	Todos los acabados	<b>202,90</b>	<b>268,14</b>



# Zehnder Radiavector



# Zehnder Radiavector

## ESPECIFICACIONES TÉCNICAS

### Modelos 211-214

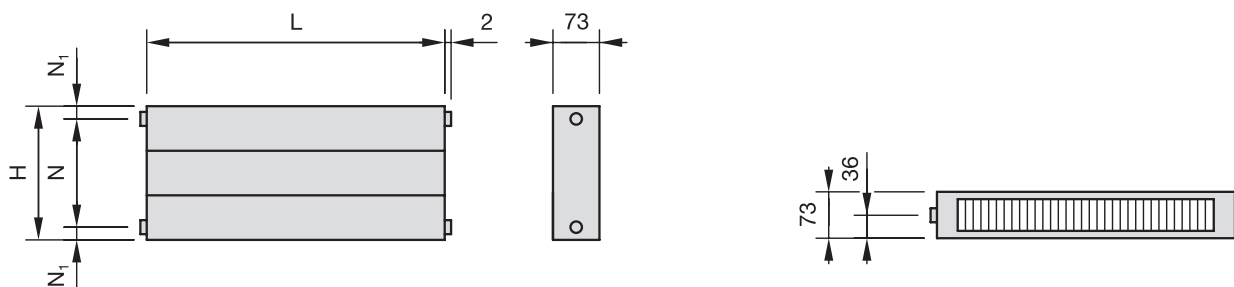

### Modelos 321-324

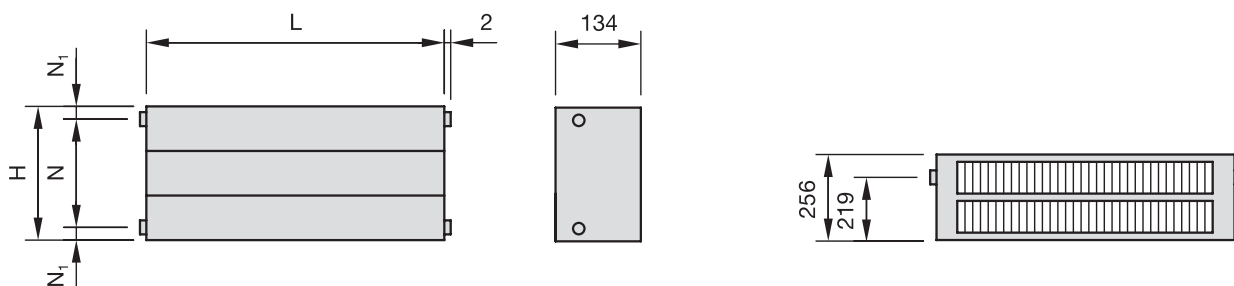

### Modelos 431-434

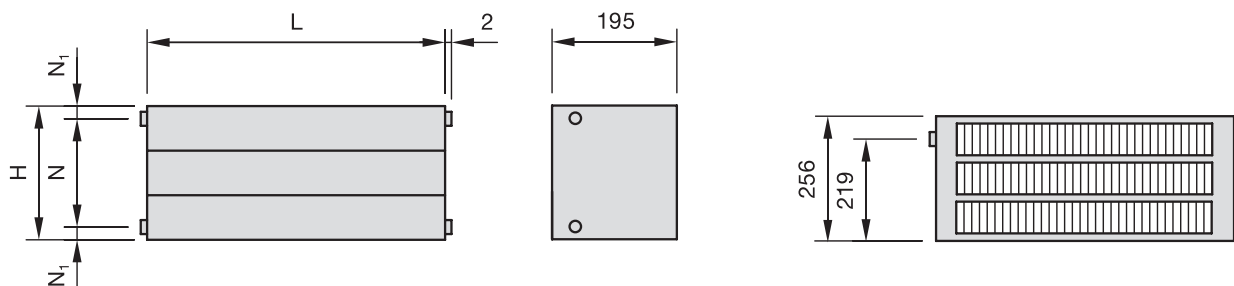

### Modelos 541-544

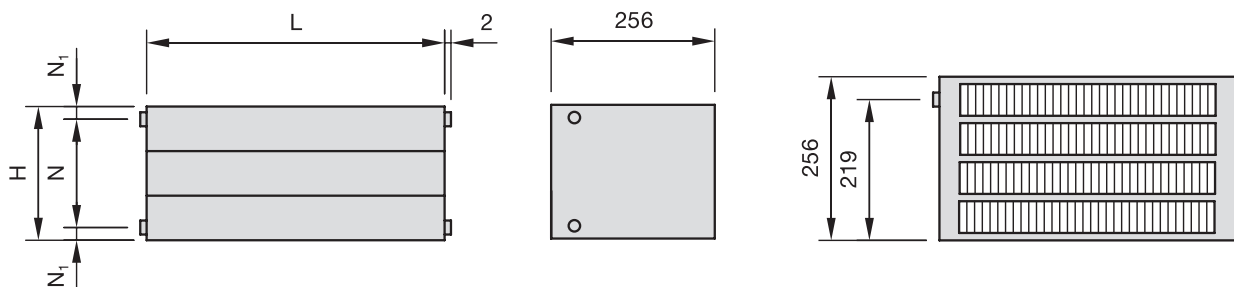

- Tubos ultraplano de acero de 70 x 11x 1,5 mm.
- Aletas de plancha de acero de 0,5 mm.
- Presión máxima de servicio 4 bar. Presión de prueba en fábrica 5,2 bar.

# Zehnder Radiavector

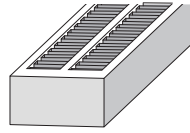
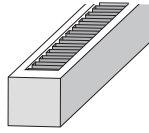
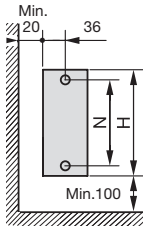

MODELO	ZRV 211	ZRV 321
Altura H	70 mm	70 mm
Entre ejes N	34 mm	34 mm
Profundidad P	73 mm	134 mm
Exponente n	1,29	1,29

Recuerde pedir el Pack de Conexión

Longitud L mm	Emisión EN 442 75/65/20 ΔT 50K W	Emisión Caldera condens. ΔT 40K W	Emisión Bomba de calor ΔT 32,5K W	Blanco RAL 9016 PVP €	Emisión EN 442 75/65/20 ΔT 50K W	Emisión Caldera condens. ΔT 40K W	Emisión Bomba de calor ΔT 32,5K W	Blanco RAL 9016 PVP €
500	213	159	122	342,43	289	217	165	448,74
600	255	191	146	353,01	347	260	199	465,96
700	298	223	170	363,60	405	303	232	483,19
800	340	255	195	374,18	462	346	265	500,41
900	383	287	219	384,77	520	390	298	517,64
1.000	425	318	243	395,35	578	433	331	534,86
1.100	468	350	268	405,93	636	476	364	552,08
1.200	510	382	292	416,52	694	520	397	569,31
1.300	553	414	316	427,10	751	563	430	586,53
1.400	595	446	341	437,69	809	606	463	603,76
1.500	638	478	365	448,27	867	650	496	620,98
1.600	680	509	389	458,85	925	693	530	638,20
1.700	723	541	414	469,44	983	736	563	655,43
1.800	765	573	438	480,02	1.040	779	596	672,65
1.900	808	605	462	490,61	1.098	823	629	689,88
2.000	850	637	487	501,19	1.156	866	662	707,10
2.200	935	700	535	522,36	1.272	953	728	741,55
2.400	1.020	764	584	543,53	1.387	1.039	794	776,00
2.600	1.105	828	633	564,69	1.503	1.126	861	810,44
2.800	1.190	891	681	585,86	1.618	1.212	927	844,89
3.000	1.275	955	730	607,03	1.734	1.299	993	879,34
3.200	1.360	1.019	779	628,20	1.850	1.386	1.059	913,79
3.400	1.445	1.083	827	649,37	1.965	1.472	1.125	948,24
3.600	1.530	1.146	876	670,53	2.081	1.559	1.191	982,68
3.800	1.615	1.210	925	691,70	2.196	1.645	1.258	1.017,13
4.000	1.700	1.274	973	712,87	2.312	1.732	1.324	1.051,58
4.200	1.785	1.337	1.022	734,04	2.428	1.819	1.390	1.086,03
4.400	1.870	1.401	1.071	755,21	2.543	1.905	1.456	1.120,48
4.600	1.955	1.465	1.119	776,37	2.659	1.992	1.522	1.154,92
4.800	2.040	1.528	1.168	797,54	2.774	2.078	1.589	1.189,37
5.000	2.125	1.592	1.217	818,71	2.890	2.165	1.655	1.223,82
5.200	2.210	1.656	1.265	839,88	3.006	2.252	1.721	1.258,27
5.400	2.295	1.719	1.314	861,05	3.121	2.338	1.787	1.292,72
5.600	2.380	1.783	1.363	882,21	3.237	2.425	1.853	1.327,16
5.800	2.465	1.847	1.411	903,38	3.352	2.511	1.920	1.361,61
6.000	2.550	1.910	1.460	924,55	3.468	2.598	1.986	1.396,06

Precios para color blanco estándar RAL 9016.

Precios para carta de colores Radiavector +25%. Otros colores, consultar.



# Zehnder Radiavector

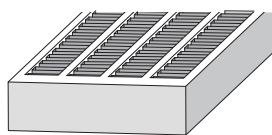
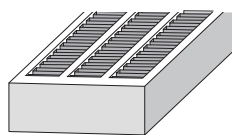
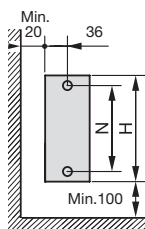

MODELO	ZRV 431	ZRV 541
Altura H	70 mm	70 mm
Entre ejes N	34 mm	34 mm
Profundidad P	195 mm	256 mm
Exponente n	1,29	1,29

Recuerde pedir el Pack de Conexión

Longitud L mm	Emisión EN 442 75/65/20 ΔT 50K W	Emisión Caldera condens. ΔT 40K W	Emisión Bomba de calor ΔT 32,5K W	Blanco RAL 9016 PVP €	Emisión EN 442 75/65/20 ΔT 50K W	Emisión Caldera condens. ΔT 40K W	Emisión Bomba de calor ΔT 32,5K W	Blanco RAL 9016 PVP €
500	405	303	232	546,93	514	385	294	631,10
600	485	364	278	572,34	617	462	353	662,13
700	566	424	324	597,74	720	539	412	693,16
800	647	485	371	623,15	822	616	471	724,19
900	728	545	417	648,55	925	693	530	755,23
1.000	809	606	463	673,96	1.028	770	589	786,26
1.100	890	667	510	699,37	1.131	847	647	817,29
1.200	971	727	556	724,77	1.234	924	706	848,33
1.300	1.052	788	602	750,18	1.336	1.001	765	879,36
1.400	1.133	848	649	775,58	1.439	1.078	824	910,39
1.500	1.214	909	695	800,99	1.542	1.155	883	941,43
1.600	1.294	970	741	826,40	1.645	1.232	942	972,46
1.700	1.375	1.030	788	851,80	1.748	1.309	1.001	1.003,49
1.800	1.456	1.091	834	877,21	1.850	1.386	1.060	1.034,52
1.900	1.537	1.152	880	902,61	1.953	1.463	1.118	1.065,56
2.000	1.618	1.212	926	928,02	2.056	1.540	1.177	1.096,59
2.200	1.780	1.333	1.019	978,83	2.262	1.694	1.295	1.158,66
2.400	1.942	1.455	1.112	1.029,64	2.467	1.848	1.413	1.220,72
2.600	2.103	1.576	1.204	1.080,46	2.673	2.002	1.530	1.282,79
2.800	2.265	1.697	1.297	1.131,27	2.878	2.156	1.648	1.344,85
3.000	2.427	1.818	1.390	1.182,08	3.084	2.310	1.766	1.406,92
3.200	2.589	1.939	1.482	1.232,89	3.290	2.464	1.884	1.468,99
3.400	2.751	2.061	1.575	1.283,70	3.495	2.618	2.001	1.531,05
3.600	2.912	2.182	1.668	1.334,52	3.701	2.772	2.119	1.593,12
3.800	3.074	2.303	1.760	1.385,33	3.906	2.926	2.237	1.655,18
4.000	3.236	2.424	1.853	1.436,14	4.112	3.081	2.355	1.717,25
4.200	3.398	2.545	1.946	1.486,95	4.318	3.235	2.472	1.779,32
4.400	3.560	2.667	2.038	1.537,76	4.523	3.389	2.590	1.841,38
4.600	3.721	2.788	2.131	1.588,58	4.729	3.543	2.708	1.903,45
4.800	3.883	2.909	2.224	1.639,39	4.934	3.697	2.825	1.965,51
5.000	4.045	3.030	2.316	1.690,20	5.140	3.851	2.943	2.027,58
5.200	4.207	3.152	2.409	1.741,01	5.346	4.005	3.061	2.089,65
5.400	4.369	3.273	2.501	1.791,82	5.551	4.159	3.179	2.151,71
5.600	4.530	3.394	2.594	1.842,64	5.757	4.313	3.296	2.213,78
5.800	4.692	3.515	2.687	1.893,45	5.962	4.467	3.414	2.275,84
6.000	4.854	3.636	2.779	1.944,26	6.168	4.621	3.532	2.337,91

Precios para color blanco estándar RAL 9016.

Precios para carta de colores Radiavector +25%. Otros colores, consultar.



# Zehnder Radiavector

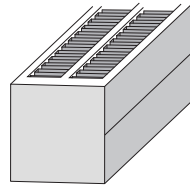
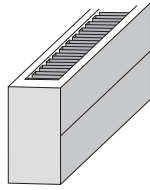
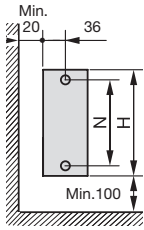

MODELO	ZRV 212	ZRV 322
Altura H	140 mm	140 mm
Entre ejes N	104 mm	104 mm
Profundidad P	73 mm	134 mm
Exponente n	1,30	1,30

Recuerde pedir el Pack de Conexión

Longitud L mm	Emisión EN 442 75/65/20 ΔT 50K W	Emisión Caldera condens. ΔT 40K W	Emisión Bomba de calor ΔT 32,5K W	Blanco RAL 9016 PVP €	Emisión EN 442 75/65/20 ΔT 50K W	Emisión Caldera condens. ΔT 40K W	Emisión Bomba de calor ΔT 32,5K W	Blanco RAL 9016 PVP €
500	262	196	150	397,64	452	338	258	561,84
600	314	235	180	415,39	542	406	310	596,54
700	367	275	210	433,15	632	473	362	631,24
800	419	314	240	450,90	722	541	413	665,94
900	472	353	270	468,66	813	609	465	700,65
1.000	524	392	300	486,41	903	676	517	735,35
1.100	576	432	330	504,17	993	744	568	770,05
1.200	629	471	360	521,92	1.084	811	620	804,76
1.300	681	510	390	539,68	1.174	879	672	839,46
1.400	734	549	420	557,43	1.264	947	723	874,16
1.500	786	589	450	575,19	1.355	1.014	775	908,87
1.600	838	628	480	592,94	1.445	1.082	827	943,57
1.700	891	667	510	610,70	1.535	1.149	878	978,27
1.800	943	706	540	628,45	1.625	1.217	930	1.012,97
1.900	996	745	570	646,21	1.716	1.285	981	1.047,68
2.000	1.048	785	600	663,96	1.806	1.352	1.033	1.082,38
2.200	1.153	863	659	699,47	1.987	1.488	1.136	1.151,79
2.400	1.258	942	719	734,98	2.167	1.623	1.240	1.221,19
2.600	1.362	1.020	779	770,49	2.348	1.758	1.343	1.290,60
2.800	1.467	1.099	839	806,00	2.528	1.893	1.446	1.360,00
3.000	1.572	1.177	899	841,51	2.709	2.028	1.550	1.429,41
3.200	1.677	1.256	959	877,02	2.890	2.164	1.653	1.498,82
3.400	1.782	1.334	1.019	912,53	3.070	2.299	1.756	1.568,22
3.600	1.886	1.413	1.079	948,04	3.251	2.434	1.860	1.637,63
3.800	1.991	1.491	1.139	983,55	3.431	2.569	1.963	1.707,03
4.000	2.096	1.569	1.199	1.019,06	3.612	2.705	2.066	1.776,44
4.200	2.201	1.648	1.259	1.054,57	3.793	2.840	2.170	1.845,85
4.400	2.306	1.726	1.319	1.090,08	3.973	2.975	2.273	1.915,25
4.600	2.410	1.805	1.379	1.125,59	4.154	3.110	2.376	1.984,66
4.800	2.515	1.883	1.439	1.161,10	4.334	3.246	2.480	2.054,06
5.000	2.620	1.962	1.499	1.196,61	4.515	3.381	2.583	2.123,47
5.200	2.725	2.040	1.559	1.232,12	4.696	3.516	2.686	2.192,88
5.400	2.830	2.119	1.619	1.267,63	4.876	3.651	2.789	2.262,28
5.600	2.934	2.197	1.679	1.303,14	5.057	3.786	2.893	2.331,69
5.800	3.039	2.276	1.739	1.338,65	5.237	3.922	2.996	2.401,09
6.000	3.144	2.354	1.799	1.374,16	5.418	4.057	3.099	2.470,50

Precios para color blanco estándar RAL 9016.

Precios para carta de colores Radiavector +25%. Otros colores, consultar.



# Zehnder Radiavector

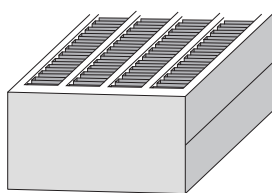
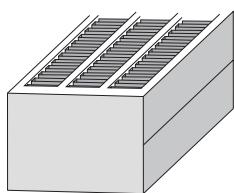
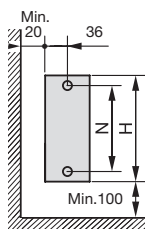

MODELO	ZRV 432	ZRV 542
Altura H	140 mm	140 mm
Entre ejes N	104 mm	104 mm
Profundidad P	195 mm	256 mm
Exponente n	1,30	1,30

Recuerde pedir el Pack de Conexión

Longitud L mm	Emisión EN 442 75/65/20 ΔT 50K W	Emisión Caldera condens. ΔT 40K W	Emisión Bomba de calor ΔT 32,5K W	Blanco RAL 9016 PVP €	Emisión EN 442 75/65/20 ΔT 50K W	Emisión Caldera condens. ΔT 40K W	Emisión Bomba de calor ΔT 32,5K W	Blanco RAL 9016 PVP €
500	632	473	361	709,63	803	601	459	864,56
600	758	567	434	759,68	964	722	551	935,77
700	884	662	506	809,74	1.124	842	643	1.006,99
800	1.010	757	578	859,79	1.285	962	735	1.078,21
900	1.137	851	650	909,85	1.445	1.082	827	1.149,42
1.000	1.263	946	723	959,90	1.606	1.203	919	1.220,64
1.100	1.389	1.040	795	1.009,96	1.767	1.323	1.011	1.291,86
1.200	1.516	1.135	867	1.060,01	1.927	1.443	1.102	1.363,07
1.300	1.642	1.229	939	1.110,07	2.088	1.563	1.194	1.434,29
1.400	1.768	1.324	1.012	1.160,12	2.248	1.684	1.286	1.505,51
1.500	1.895	1.419	1.084	1.210,18	2.409	1.804	1.378	1.576,73
1.600	2.021	1.513	1.156	1.260,23	2.570	1.924	1.470	1.647,94
1.700	2.147	1.608	1.228	1.310,29	2.730	2.044	1.562	1.719,16
1.800	2.273	1.702	1.301	1.360,34	2.891	2.165	1.654	1.790,38
1.900	2.400	1.797	1.373	1.410,40	3.051	2.285	1.746	1.861,59
2.000	2.526	1.891	1.445	1.460,45	3.212	2.405	1.837	1.932,81
2.200	2.779	2.081	1.590	1.560,56	3.533	2.646	2.021	2.075,24
2.400	3.031	2.270	1.734	1.660,67	3.854	2.886	2.205	2.217,68
2.600	3.284	2.459	1.879	1.760,78	4.176	3.127	2.389	2.360,11
2.800	3.536	2.648	2.023	1.860,89	4.497	3.367	2.572	2.502,55
3.000	3.789	2.837	2.168	1.961,00	4.818	3.608	2.756	2.644,98
3.200	4.042	3.026	2.312	2.061,11	5.139	3.848	2.940	2.787,41
3.400	4.294	3.215	2.457	2.161,22	5.460	4.089	3.124	2.929,85
3.600	4.547	3.405	2.601	2.261,33	5.782	4.329	3.307	3.072,28
3.800	4.799	3.594	2.746	2.361,44	6.103	4.570	3.491	3.214,72
4.000	5.052	3.783	2.890	2.461,55	6.424	4.810	3.675	3.357,15
4.200	5.305	3.972	3.035	2.561,66	6.745	5.051	3.859	3.499,58
4.400	5.557	4.161	3.179	2.661,77	7.066	5.291	4.042	3.642,02
4.600	5.810	4.350	3.324	2.761,88	7.388	5.532	4.226	3.784,45
4.800	6.062	4.539	3.468	2.861,99	7.709	5.772	4.410	3.926,89
5.000	6.315	4.729	3.613	2.962,10	8.030	6.013	4.594	4.069,32
5.200	6.568	4.918	3.757	3.062,21	8.351	6.253	4.777	4.211,75
5.400	6.820	5.107	3.902	3.162,32	8.672	6.494	4.961	4.354,19
5.600	7.073	5.296	4.046	3.262,43	8.994	6.734	5.145	4.496,62
5.800	7.325	5.485	4.191	3.362,54	9.315	6.975	5.329	4.639,06
6.000	7.578	5.674	4.335	3.462,65	9.636	7.215	5.512	4.781,49

Precios para color blanco estándar RAL 9016.

Precios para carta de colores Radiavector +25%. Otros colores, consultar.



# Zehnder Radiavector

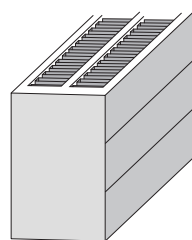
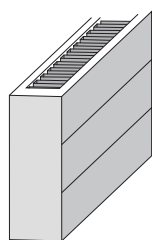
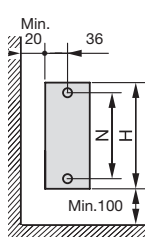

MODELO	ZRV 213	ZRV 323
Altura H	210 mm	210 mm
Entre ejes N	174 mm	174 mm
Profundidad P	73 mm	134 mm
Exponente n	1,30	1,30

Recuerde pedir el Pack de Conexión

Longitud L mm	Emisión EN 442 75/65/20 ΔT 50K W	Emisión Caldera condens. ΔT 40K W	Emisión Bomba de calor de calor ΔT 32,5K W	Blanco RAL 9016 PVP €	Emisión EN 442 75/65/20 ΔT 50K W	Emisión Caldera condens. ΔT 40K W	Emisión Bomba de calor de calor ΔT 32,5K W	Blanco RAL 9016 PVP €
500	342	256	195	457,82	588	440	336	657,71
600	410	307	234	480,10	706	528	403	696,39
700	478	358	273	502,39	823	616	470	735,08
800	546	409	312	524,68	941	704	538	773,77
900	615	460	351	546,96	1.058	792	605	812,46
1.000	683	511	390	569,25	1.176	880	672	851,15
1.100	751	562	429	591,54	1.294	968	739	889,84
1.200	820	613	468	613,82	1.411	1.056	807	928,53
1.300	888	665	507	636,11	1.529	1.144	874	967,22
1.400	956	716	547	658,40	1.646	1.232	941	1.005,91
1.500	1.025	767	586	680,69	1.764	1.320	1.008	1.044,60
1.600	1.093	818	625	702,97	1.882	1.408	1.075	1.083,28
1.700	1.161	869	664	725,26	1.999	1.496	1.143	1.121,97
1.800	1.229	920	703	747,55	2.117	1.584	1.210	1.160,66
1.900	1.298	971	742	769,83	2.234	1.672	1.277	1.199,35
2.000	1.366	1.022	781	792,12	2.352	1.760	1.344	1.238,04
2.200	1.503	1.125	859	836,69	2.587	1.936	1.479	1.315,42
2.400	1.639	1.227	937	881,27	2.822	2.112	1.613	1.392,80
2.600	1.776	1.329	1.015	925,84	3.058	2.288	1.748	1.470,17
2.800	1.912	1.431	1.093	970,42	3.293	2.464	1.882	1.547,55
3.000	2.049	1.534	1.171	1.014,99	3.528	2.640	2.016	1.624,93
3.200	2.186	1.636	1.249	1.059,56	3.763	2.817	2.151	1.702,31
3.400	2.322	1.738	1.327	1.104,14	3.998	2.993	2.285	1.779,69
3.600	2.459	1.840	1.405	1.148,71	4.234	3.169	2.420	1.857,06
3.800	2.595	1.942	1.483	1.193,29	4.469	3.345	2.554	1.934,44
4.000	2.732	2.045	1.561	1.237,86	4.704	3.521	2.689	2.011,82
4.200	2.869	2.147	1.640	1.282,43	4.939	3.697	2.823	2.089,20
4.400	3.005	2.249	1.718	1.327,01	5.174	3.873	2.957	2.166,58
4.600	3.142	2.351	1.796	1.371,58	5.410	4.049	3.092	2.243,95
4.800	3.278	2.454	1.874	1.416,16	5.645	4.225	3.226	2.321,33
5.000	3.415	2.556	1.952	1.460,73	5.880	4.401	3.361	2.398,71
5.200	3.552	2.658	2.030	1.505,30	6.115	4.577	3.495	2.476,09
5.400	3.688	2.760	2.108	1.549,88	6.350	4.753	3.630	2.553,47
5.600	3.825	2.863	2.186	1.594,45	6.586	4.929	3.764	2.630,84
5.800	3.961	2.965	2.264	1.639,03	6.821	5.105	3.898	2.708,22
6.000	4.098	3.067	2.342	1.683,60	7.056	5.281	4.033	2.785,60

Precios para color blanco estándar RAL 9016.

Precios para carta de colores Radiavector +25%. Otros colores, consultar.



# Zehnder Radiavector

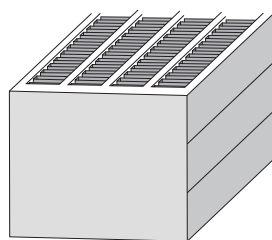
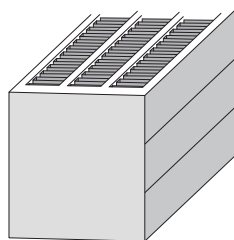
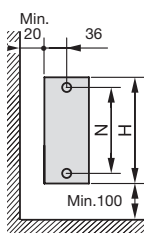

MODELO	ZRV 433	ZRV 543
Altura H	210 mm	210 mm
Entre ejes N	174 mm	174 mm
Profundidad P	195 mm	256 mm
Exponente n	1,35	1,31

Recuerde pedir el Pack de Conexión

Longitud L mm	Emisión EN 442 75/65/20 ΔT 50K W	Emisión Caldera condens. ΔT 40K W	Emisión Bomba de calor ΔT 32,5K W	Blanco RAL 9016 PVP €	Emisión EN 442 75/65/20 ΔT 50K W	Emisión Caldera condens. ΔT 40K W	Emisión Bomba de calor ΔT 32,5K W	Blanco RAL 9016 PVP €
500	823	616	470	885,57	1.046	783	598	1.144,46
600	987	739	564	944,75	1.255	939	717	1.226,74
700	1.152	862	658	1.003,93	1.464	1.096	837	1.309,03
800	1.316	985	752	1.063,11	1.674	1.253	957	1.391,31
900	1.481	1.108	846	1.122,29	1.883	1.409	1.076	1.473,60
1.000	1.645	1.231	940	1.181,47	2.092	1.566	1.196	1.555,88
1.100	1.810	1.354	1.034	1.240,65	2.301	1.722	1.315	1.638,17
1.200	1.974	1.477	1.128	1.299,83	2.510	1.879	1.435	1.720,45
1.300	2.139	1.601	1.222	1.359,01	2.720	2.035	1.554	1.802,74
1.400	2.303	1.724	1.316	1.418,19	2.929	2.192	1.674	1.885,02
1.500	2.468	1.847	1.410	1.477,37	3.138	2.349	1.794	1.967,31
1.600	2.632	1.970	1.504	1.536,55	3.347	2.505	1.913	2.049,59
1.700	2.797	2.093	1.598	1.595,73	3.556	2.662	2.033	2.131,88
1.800	2.961	2.216	1.692	1.654,91	3.766	2.818	2.152	2.214,16
1.900	3.126	2.339	1.786	1.714,09	3.975	2.975	2.272	2.296,45
2.000	3.290	2.462	1.880	1.773,27	4.184	3.131	2.391	2.378,73
2.200	3.619	2.709	2.068	1.891,63	4.602	3.445	2.630	2.543,30
2.400	3.948	2.955	2.256	2.009,99	5.021	3.758	2.870	2.707,87
2.600	4.277	3.201	2.444	2.128,35	5.439	4.071	3.109	2.872,44
2.800	4.606	3.447	2.633	2.246,71	5.858	4.384	3.348	3.037,01
3.000	4.935	3.694	2.821	2.365,07	6.276	4.697	3.587	3.201,58
3.200	5.264	3.940	3.009	2.483,43	6.694	5.010	3.826	3.366,15
3.400	5.593	4.186	3.197	2.601,79	7.113	5.323	4.065	3.530,72
3.600	5.922	4.432	3.385	2.720,15	7.531	5.637	4.304	3.695,29
3.800	6.251	4.678	3.573	2.838,51	7.950	5.950	4.544	3.859,86
4.000	6.580	4.925	3.761	2.956,87	8.368	6.263	4.783	4.024,43
4.200	6.909	5.171	3.949	3.075,23	8.786	6.576	5.022	4.189,00
4.400	7.238	5.417	4.137	3.193,59	9.205	6.889	5.261	4.353,57
4.600	7.567	5.663	4.325	3.311,95	9.623	7.202	5.500	4.518,14
4.800	7.896	5.910	4.513	3.430,31	10.042	7.515	5.739	4.682,71
5.000	8.225	6.156	4.701	3.548,67	10.460	7.829	5.978	4.847,28
5.200	8.554	6.402	4.889	3.667,03	10.878	8.142	6.217	5.011,85
5.400	8.883	6.648	5.077	3.785,39	11.297	8.455	6.457	5.176,42
5.600	9.212	6.895	5.265	3.903,75	11.715	8.768	6.696	5.340,99
5.800	9.541	7.141	5.453	4.022,11	12.134	9.081	6.935	5.505,56
6.000	9.870	7.387	5.641	4.140,47	12.552	9.394	7.174	5.670,13

Precios para color blanco estándar RAL 9016.

Precios para carta de colores Radiavector +25%. Otros colores, consultar.





# Zehnder Radiavector

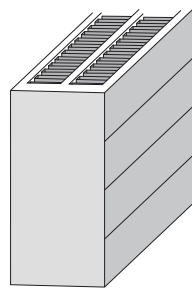
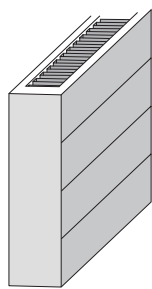
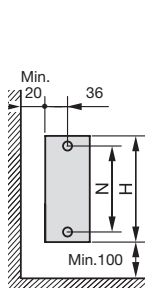

MODELO	ZRV 214	ZRV 324
Altura H	280 mm	280 mm
Entre ejes N	244 mm	244 mm
Profundidad P	73 mm	134 mm
Exponente n	1,30	1,30

Recuerde pedir el Pack de Conexión

Longitud L mm	Emisión EN 442 75/65/20 ΔT 50K W	Emisión Caldera condens. ΔT 40K W	Emisión Bomba de calor ΔT 32,5K W	Blanco RAL 9016 PVP €	Emisión EN 442 75/65/20 ΔT 50K W	Emisión Caldera condens. ΔT 40K W	Emisión Bomba de calor ΔT 32,5K W	Blanco RAL 9016 PVP €
500	413	309	236	599,15	711	532	406	738,20
600	496	371	283	628,91	853	638	487	791,01
700	578	433	330	658,68	995	745	568	843,83
800	661	494	377	688,44	1.138	851	650	896,64
900	743	556	424	718,21	1.280	957	731	949,46
1.000	826	618	472	747,97	1.422	1.064	812	1.002,27
1.100	909	680	519	777,74	1.564	1.170	893	1.055,09
1.200	991	741	566	807,50	1.706	1.276	974	1.107,90
1.300	1.074	803	613	837,27	1.849	1.383	1.056	1.160,72
1.400	1.156	865	660	867,03	1.991	1.489	1.137	1.213,53
1.500	1.239	927	707	896,80	2.133	1.596	1.218	1.266,35
1.600	1.322	989	755	926,56	2.275	1.702	1.299	1.319,16
1.700	1.404	1.050	802	956,33	2.417	1.808	1.380	1.371,98
1.800	1.487	1.112	849	986,09	2.560	1.915	1.462	1.424,79
1.900	1.569	1.174	896	1.015,86	2.702	2.021	1.543	1.477,61
2.000	1.652	1.236	943	1.045,62	2.844	2.127	1.624	1.530,42
2.200	1.817	1.359	1.038	1.105,15	3.128	2.340	1.786	1.636,05
2.400	1.982	1.483	1.132	1.164,68	3.413	2.553	1.949	1.741,68
2.600	2.148	1.607	1.226	1.224,21	3.697	2.766	2.111	1.847,31
2.800	2.313	1.730	1.321	1.283,74	3.982	2.978	2.274	1.952,94
3.000	2.478	1.854	1.415	1.343,27	4.266	3.191	2.436	2.058,57
3.200	2.643	1.977	1.509	1.402,80	4.550	3.404	2.598	2.164,20
3.400	2.808	2.101	1.604	1.462,33	4.835	3.617	2.761	2.269,83
3.600	2.974	2.224	1.698	1.521,86	5.119	3.829	2.923	2.375,46
3.800	3.139	2.348	1.792	1.581,39	5.404	4.042	3.085	2.481,09
4.000	3.304	2.472	1.887	1.640,92	5.688	4.255	3.248	2.586,72
4.200	3.469	2.595	1.981	1.700,45	5.972	4.468	3.410	2.692,35
4.400	3.634	2.719	2.075	1.759,98	6.257	4.680	3.573	2.797,98
4.600	3.800	2.842	2.170	1.819,51	6.541	4.893	3.735	2.903,61
4.800	3.965	2.966	2.264	1.879,04	6.826	5.106	3.897	3.009,24
5.000	4.130	3.090	2.358	1.938,57	7.110	5.319	4.060	3.114,87
5.200	4.295	3.213	2.453	1.998,10	7.394	5.531	4.222	3.220,50
5.400	4.460	3.337	2.547	2.057,63	7.679	5.744	4.385	3.326,13
5.600	4.626	3.460	2.641	2.117,16	7.963	5.957	4.547	3.431,76
5.800	4.791	3.584	2.736	2.176,69	8.248	6.170	4.709	3.537,39
6.000	4.956	3.707	2.830	2.236,22	8.532	6.382	4.872	3.643,02

Precios para color blanco estándar RAL 9016.

Precios para carta de colores Radiavector +25%. Otros colores, consultar.



# Zehnder Radiavector

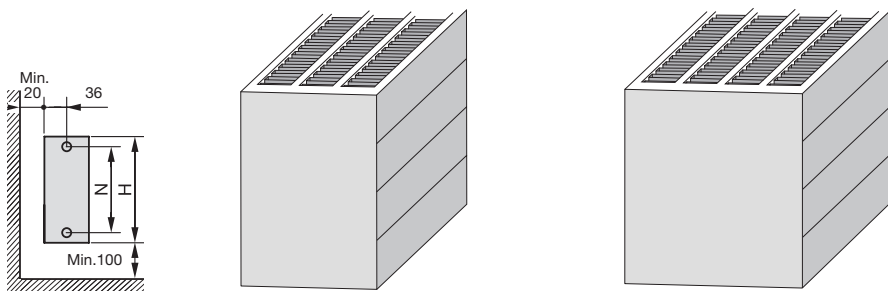

MODELO	ZRV 434	ZRV 544
Altura H	280 mm	280 mm
Entre ejes N	244 mm	244 mm
Profundidad P	195 mm	256 mm
Exponente n	1,30	1,30

Recuerde pedir el Pack de Conexión

Longitud L mm	Emisión EN 442 75/65/20 $\Delta T$ 50K W	Emisión Caldera condens. $\Delta T$ 40K W	Emisión Bomba de calor $\Delta T$ 32,5K W	Blanco RAL 9016 PVP €	Emisión EN 442 75/65/20 $\Delta T$ 50K W	Emisión Caldera condens. $\Delta T$ 40K W	Emisión Bomba de calor $\Delta T$ 32,5K W	Blanco RAL 9016 PVP €
500	995	744	568	997,06	1.265	946	722	1.273,21
600	1.194	893	682	1.075,00	1.518	1.136	867	1.380,33
700	1.393	1.042	795	1.152,94	1.771	1.325	1.011	1.487,45
800	1.592	1.191	909	1.230,89	2.024	1.514	1.156	1.594,57
900	1.791	1.340	1.023	1.308,83	2.277	1.703	1.300	1.701,69
1.000	1.990	1.489	1.136	1.386,77	2.530	1.893	1.445	1.808,81
1.100	2.189	1.638	1.250	1.464,71	2.783	2.082	1.589	1.915,93
1.200	2.388	1.786	1.364	1.542,65	3.036	2.271	1.734	2.023,05
1.300	2.587	1.935	1.477	1.620,60	3.289	2.460	1.878	2.130,17
1.400	2.786	2.084	1.591	1.698,54	3.542	2.650	2.022	2.237,29
1.500	2.985	2.233	1.704	1.776,48	3.795	2.839	2.167	2.344,42
1.600	3.184	2.382	1.818	1.854,42	4.048	3.028	2.311	2.451,54
1.700	3.383	2.531	1.932	1.932,36	4.301	3.217	2.456	2.558,66
1.800	3.582	2.680	2.045	2.010,31	4.554	3.407	2.600	2.665,78
1.900	3.781	2.828	2.159	2.088,25	4.807	3.596	2.745	2.772,90
2.000	3.980	2.977	2.273	2.166,19	5.060	3.785	2.889	2.880,02
2.200	4.378	3.275	2.500	2.322,07	5.566	4.164	3.178	3.094,26
2.400	4.776	3.573	2.727	2.477,96	6.072	4.542	3.467	3.308,50
2.600	5.174	3.870	2.954	2.633,84	6.578	4.921	3.756	3.522,75
2.800	5.572	4.168	3.182	2.789,73	7.084	5.299	4.045	3.736,99
3.000	5.970	4.466	3.409	2.945,61	7.590	5.678	4.334	3.951,23
3.200	6.368	4.764	3.636	3.101,49	8.096	6.056	4.623	4.165,47
3.400	6.766	5.061	3.863	3.257,38	8.602	6.435	4.912	4.379,71
3.600	7.164	5.359	4.091	3.413,26	9.108	6.813	5.201	4.593,96
3.800	7.562	5.657	4.318	3.569,15	9.614	7.192	5.490	4.808,20
4.000	7.960	5.955	4.545	3.725,03	10.120	7.570	5.779	5.022,44
4.200	8.358	6.252	4.772	3.880,91	10.626	7.949	6.067	5.236,68
4.400	8.756	6.550	5.000	4.036,80	11.132	8.327	6.356	5.450,92
4.600	9.154	6.848	5.227	4.192,68	11.638	8.706	6.645	5.665,17
4.800	9.552	7.146	5.454	4.348,57	12.144	9.085	6.934	5.879,41
5.000	9.950	7.443	5.681	4.504,45	12.650	9.463	7.223	6.093,65
5.200	10.348	7.741	5.909	4.660,33	13.156	9.842	7.512	6.307,89
5.400	10.746	8.039	6.136	4.816,22	13.662	10.220	7.801	6.522,13
5.600	11.144	8.336	6.363	4.972,10	14.168	10.599	8.090	6.736,38
5.800	11.542	8.634	6.591	5.127,99	14.674	10.977	8.379	6.950,62
6.000	11.940	8.932	6.818	5.283,87	15.180	11.356	8.668	7.164,86

Precios para color blanco estándar RAL 9016.

Precios para carta de colores Radiavector +25%. Otros colores, consultar.



# Zehnder Radiavector

## FIGURAS DE CONEXIÓN

**Conexiones Bitubo normales.** Sin suplemento de precio.

Misma mano



Cruzados



Lados opuestos



**Conexiones Bitubo especiales.** Con suplemento de precio **58,43 €.**

Desde abajo / hacia abajo

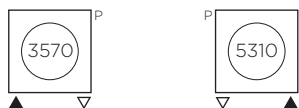

Desde arriba / hacia arriba

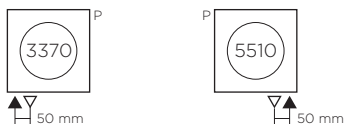

**Especiales para pies soldados WF**



■ Racores en paralelo con la pared.  
(Uno al lado del otro).

■ Racores en perpendicular a la pared. (Uno delante del otro).  
■ Impulsión (entrada) por el racor más externo.

**Conexiones Mono-bitubo.** Con suplemento de precio **58,43 €.**

Únicamente disponible con conexión de 50 mm entre ejes. Usar válvula Mono-bitubo (Tipo O, P o Q) con el *bypass* abierto.

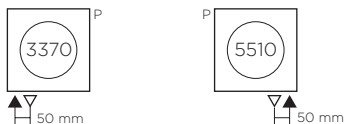

## MEDIDAS DE RACORES

Otras posiciones de racores, por ejemplo desde arriba hacia arriba, hacia atrás o adelante, pueden suministrarse bajo pedido, con suplemento de precio a consultar.

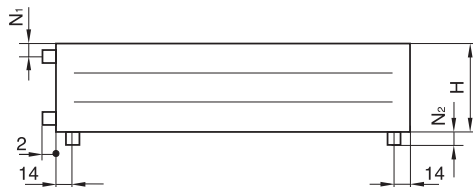
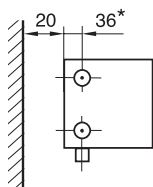

## REJILLAS

Bajo pedido, están disponibles tres tipos de rejillas. Sujeción de las rejillas por muelles internos. Posibilidad de pedir las soldadas. Precios a consultar.

Tipo A



Tipo B



Tipo C



# Zehnder Radiavector

## SOPORTES ESTÁNDAR FMORV

### Kit de soportes

Soportes de pie atornillados incluidos en el embalaje.  
En el color del radiador solo con el pedido inicial.  
Cada radiador lleva el Kit con su cantidad y tipo necesario de soportes. (Al suelo).

### Kit de soportes adicional

Al pedir un Kit de soportes adicional hay que indicar para que radiador. Diferentes radiadores usan diferentes kits.

Blanco estándar (RAL 9016)

PVP **54,67 €**

Nº de soportes en función de la longitud	
Longitudes	Número de soportes
400 - 2.000 mm	2
2.200 - 4.000 mm	3
4.200 - 6.000 mm	4

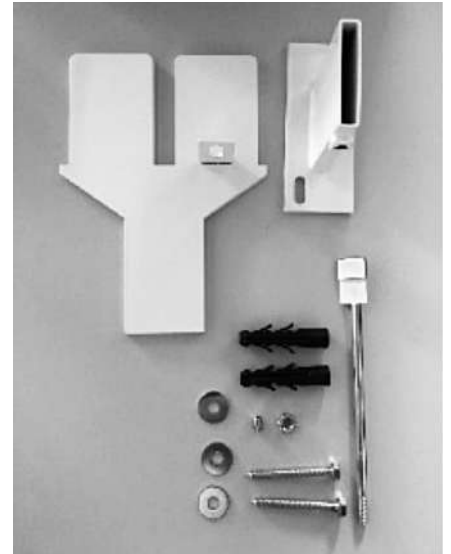
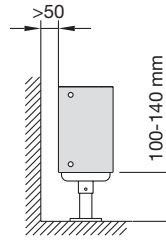

## SOPORTES A MURAL ATORNILLADOS WMORV

Soportes a la pared únicamente bajo pedido.  
Dado el peso del radiador y su profundidad, es necesario asegurarse que la pared resiste el peso del radiador.  
Respetar el número mínimo de soportes.

Blanco estándar (RAL 9016)

PVP5 **82,01 €**

Nº de soportes en función de la longitud	
Longitudes	Número de soportes
400 - 2.000 mm	2
2.200 - 4.000 mm	3
4.200 - 6.000 mm	4

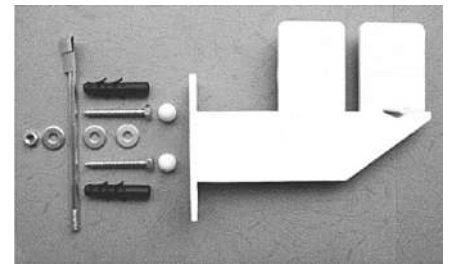
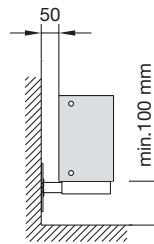

## SOPORTES A PIE ATORNILLADOS WF

Soportes al suelo únicamente bajo pedido.  
Longitud máxima del radiador 3 metros.  
Las conexiones del radiador están integradas dentro del bloque de soporte.  
Solamente con las figuras de conexión S075 y S076.  
(Ver página 252).

Blanco estándar (RAL 9016)

PVP **176,16 €**



# Válvulas

Packs de conexión y válvulas de diseño





Pasión por el diseño y la innovación, también en los detalles. Zehnder completa sus radiadores y toalleros con válvulas que se integran, con elegancia, en formas y superficies. Con la más alta calidad técnica y de materiales. Y la mejor respuesta en conexiones de pared o de suelo, en obra nueva o rehabilitación. Función y estética en perfecta armonía.

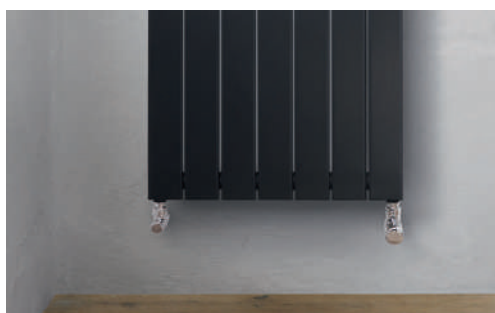
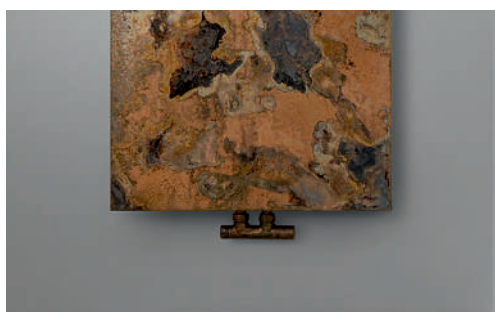



# Pack de conexión

## CONCEPTO

El Pack de Conexión permite pedir todas las piezas necesarias para la conexión de un radiador o toallero de agua o mixto.

Pidiendo el Pack de Conexión junto a un toallero o radiador, se suministran las válvulas en el acabado más conveniente a ese radiador, sin importar ni el acabado del radiador ni el tipo de tubería que se instalará. Con los adaptadores estándar están cubiertos más del 90 % de los casos.

## COMPOSICIÓN



Incluye: Juego de válvula y detentor a escuadra. También disponible válvula central de 50 mm entre ejes.



Incluye: Juego de biconos con: 2 biconos para tubo multicapa 12-16 mm.  
2 biconos para tubo de cobre de 12 mm.  
2 biconos para tubo de cobre de 14 mm.  
2 biconos para tubo de cobre de 15 mm.  
2 biconos para tubo PEX 12X1 mm.



Incluye: Juego de 2 tubos embellecedores para ocultar los tubos de la instalación (cobre o multicapa) + Rosetas para la pared.



Opcional: Para la regulación termostática, 1 cabezal termostático del mismo acabado de las válvulas.

## CONFIGURACIÓN DEL PACK DE CONEXIÓN





Disponemos de packs de conexión para todas las válvulas de nuestra tarifa. Consulte los tipos de pack de conexión la página 258. Para adquirir uno, solo tiene que indicar el tipo de válvula con el pedido. Para más información sobre los tipos de válvulas en la página 260.

- Válvulas blancas para radiadores blancos.
- Válvulas cromadas para radiadores cromados y en color.
- Válvulas inox para radiadores acabado inox.
- Válvulas monobitubo de 50 mm entre ejes para radiadores con conexiones de 50 mm entre ejes.





Recuerde pedir siempre que sea necesario el pack de conexión al realizar el pedido del radiador o toallero.



# Pack de conexión



PACK	TIPO	ACABADO	REFERENCIA	PVP €
 <p>Pack de conexión tipo B</p>	Manual	Blanco	30004245	202,59
		Cromado	30004244	
	Termostático	Blanco	30004324	268,14
		Cromado	30004323	
 <p>Pack de conexión tipo C</p>	Manual	Blanco	30004291	202,59
		Cromado	30004290	
	Termostático	Blanco	30004330	268,14
		Cromado	30004329	
 <p>Pack de conexión tipo D</p>	Manual	Blanco	30004293	202,59
		Cromado	30004292	
	Termostático	Blanco	30004332	268,14
		Cromado	30004331	
 <p>Pack de conexión tipo E</p>	Manual	Blanco	30004295	202,59
		Cromado	30004294	
	Termostático	Blanco	30004320	268,14
		Cromado	30004319	
 <p>Pack de conexión tipo F</p>	Manual	Blanco	30004297	202,59
		Cromado	30004296	
	Termostático	Blanco	30004322	268,14
		Cromado	30004321	
 <p>Pack de conexión tipo J</p>	Manual	Blanco	30004299	202,59
		Cromado	30004298	
	Termostático	Blanco	30004334	268,14
		Cromado	30004333	
 <p>Pack de conexión tipo K</p>	Manual	Blanco	30004301	202,59
		Cromado	30004300	
	Termostático	Blanco	30004336	268,14
		Cromado	30004335	

Para otros acabados o colores de nuestras cartas, consultar.





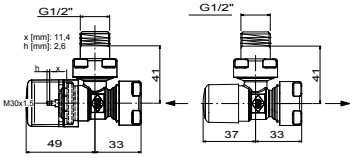

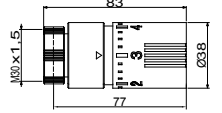



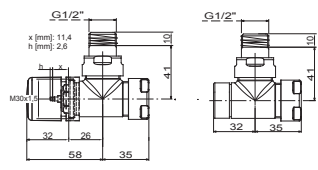

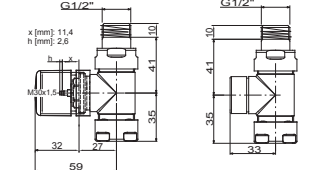

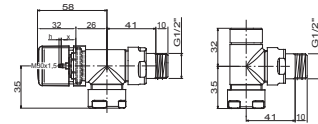

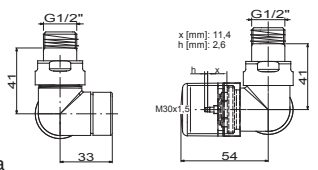
PACK	TIPO	ACABADO	REFERENCIA	PVP €
 Pack de conexión tipo M	Manual	Blanco	30004303	202,59
		Cromado	30004302	
	Termostático	Blanco	30004338	268,14
		Cromado	30004337	
 Pack de conexión tipo N No incluye rosetas.	Manual	Blanco	30004305	202,59
		Cromado	30004304	
	Termostático	Blanco	30004340	268,14
		Cromado	30004339	
 Pack de conexión tipo O	Manual	Blanco	30004307	202,59
		Cromado	300074306	
	Termostático	Blanco	30004342	268,14
		Cromado	30004341	
 Pack de conexión tipo P	Manual	Blanco	30004309	202,59
		Cromado	30004308	
	Termostático	Blanco	30004344	268,14
		Cromado	30004343	
 Pack de conexión tipo Q	Manual	Blanco	30004314	202,59
		Cromado	30004313	
	Termostático	Blanco	30004350	268,14
		Cromado	30004349	

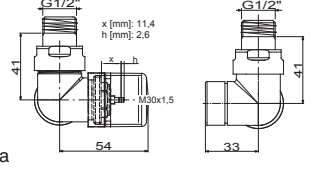

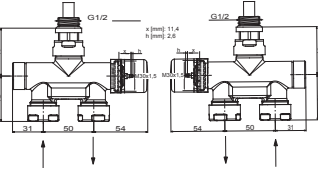

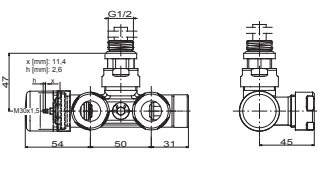

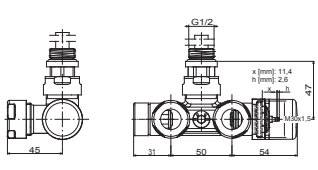

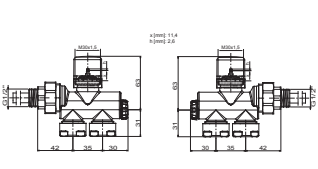

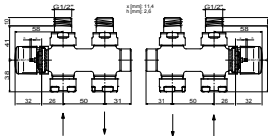
Para otros acabados o colores de nuestras cartas, consultar.

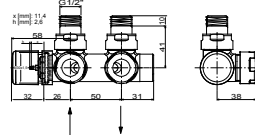
## Válvulas basic

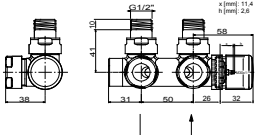
TIPO	IMAGEN	DATOS TÉCNICOS	REFERENCIA	DESCRIPCIÓN	ACABADO	PVP €
A			30004243	Kit Basic (juego de válvula + detentor escuadra y adaptadores multicapa 12-16mm y cobre 15mm)	Cromado	79,11
			30004782	Kit Basic (juego de válvula + detentor escuadra y adaptadores multicapa 12-16mm y cobre 15mm)	Blanco	79,11
Y			30003555	Cabezal termostático basic	Cromado	39,35
			30003556	Cabezal termostático basic	Blanco	20,07

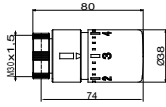
# Válvulas de diseño

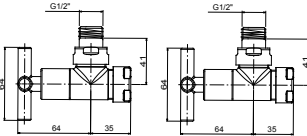
TIPO	IMAGEN	DATOS TÉCNICOS	REFERENCIA	ACABADO	PVP €
B	 <p>Válvula + detentor escuadra</p>		30003981	Cromado	134,25
			30003982	Blanco	134,25
			838899	Color	165,03
			30003984	Rame Acidato	185,85
			30003985	Ottone Acidato	185,85
			30003986	Aluminio	185,85
			30003987	Inox Satinado	185,85
			30005991	Oro	401,02
			30005992	Cromo Negro	401,02
			30005993	Bronce	401,02
C	 <p>Válvula + detentor recto</p>		30003988	Cromado	134,25
			30003989	Blanco	134,25
			839619	Color	165,03
			30005918	Oro	401,02
			30005919	Cromo Negro	401,02
			30005990	Bronce	401,02
D	 <p>Válvula + detentor escuadra inversa</p>		30003990	Cromado	134,25
			30003991	Blanco	134,25
			839629	Color	180,59
E	 <p>Válvula + detentor doble escuadra. Impulsión derecha</p>		30003992	Cromado	185,85
			30003993	Blanco	185,85
			839639	Color	196,94
F	 <p>Válvula + detentor doble escuadra. Impulsión izquierda</p>		30003994	Cromado	185,85
			30003995	Blanco	185,85
			839649	Color	196,94
J	 <p>Válvula monotubo vertical recta</p>		30004000	Cromado	185,85
			30004001	Blanco	185,85
K	 <p>Válvula monotubo vertical escuadra derecha</p>		30004002	Cromado	185,85
			30004003	Blanco	185,85
M	 <p>Válvula monotubo vertical escuadra izquierda</p>		30004003	Cromado	185,85
			30004005	Blanco	185,85
N	 <p>Válvula monotubo horizontal</p>		30004006	Cromado	153,35
			30004006	Blanco	153,35

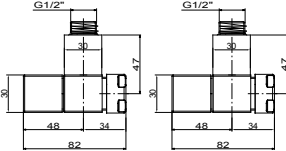
TIPO	IMAGEN	DATOS TÉCNICOS	REFERENCIA	ACABADO	PVP €
O			30004008	Cromado	153,35
			30004009	Blanco	153,35
			839049	Color	191,44
Válvula monobitubo 50 mm recta reversible.					
P			30004010	Cromado	153,35
			30004011	Blanco	153,35
			839059	Color	191,76
			30004012	Rame Acidato	222,16
			30004013	Ottone Acidato	222,16
			30004014	Aluminio	222,16
Válvula monobitubo 50 mm escuadra derecha					
Q			30004015	Inox Satinado	222,16
			30004016	Cromado	153,35
			30004017	Blanco	153,35
			839109	Color	191,76
			30004021	Rame Acidato	222,16
			30004022	Ottone Acidato	222,16
Válvula monobitubo 50 mm escuadra izquierda					
X			40004746	Cromado	153,35
			40004745	Blanco	153,35
			841279	Color	191,76
			30001460	Rame Acidato	222,16
			30001461	Ottone Acidato	222,16
			30001462	Aluminio	222,16
Cabezal termostático					
V			30004031	Cromado	233,27
W			30004032	Cromado	233,27

## RESUMEN

	A	B	C	D	E	F	J	K	M	N	O	P	Q	V	W	X
Cromada	•	•	•	•	•	•	•	•	•	•	•	•	•	•	•	•
Blanca	•	•	•	•	•	•	•	•	•	•	•	•	•			•
Color		•	•	•	•	•					•	•	•			•
Acabado Finishes		•										•	•			•
Acabdos PVD		•	•													

Para válvulas a color, consultar carta de colores Zehnder World of Colours, ver página 10.

Válvulas en acabados finishes: rame acidato, ottone acidato, aluminio, inox satinato. Ver acabados en página 15.

Válvulas en acabados PVD: oro, cromo negro y bronce. Ver acabados en página 15.

Para otros acabados o combinaciones, consultar precio.

### IMPORTANTE:



Las válvulas de diseño no incluyen pack de conexión.

Al solicitar valvulería, recuerde solicitar los biconos, no incluidos en el PVP.









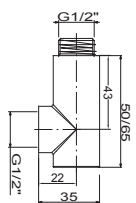

Importante especificar el tipo de adaptador al realizar el pedido.

# Accesorios

TIPO	IMAGEN	DATOS TÉCNICOS	REFERENCIA	DESCRIPCIÓN	ACABADO	PVP €	
5			30004045	Juego de 2 biconos para tubo de cobre de 10mm	Latón	8,99	
6			30004046	Juego de 2 biconos para tubo de cobre de 12mm	Latón	8,99	
7			30004047	Juego de 2 biconos para tubo de cobre de 14mm	Latón	8,99	
8			30004048	Juego de 2 biconos para tubo de cobre de 15mm	Latón	8,99	
9			30004049	Juego de 2 biconos para tubo de cobre de 16mm	Latón	8,99	
11				30004051	Juego de 2 biconos para tubo de cobre de 18mm y 2 tuercas 18mm 3/4" Euroconus	Tuercas: Cromado Biconos: Latón	29,62
13				30004053	Juego de 2 biconos para tubo multicapa 10-14mm	Latón	11,64
3				30004043	Juego de 2 biconos para tubo multicapa 12-16mm	Latón	11,64
12 D				30000511	Juego de 2 biconos para tubo multicapa 14-18mm y 2 tuercas 18mm 3/4" Euroconus	Tuercas: Cromado Biconos: Latón	29,62
12			30004052	Juego de 2 biconos para tubo multicapa 16-20mm y 2 tuercas 20,8mm 3/4" Euroconus	Tuercas: Cromado Biconos: Latón	29,62	
12 C			30000513	Juego de 2 biconos para tubo multicapa 15-20mm y 2 tuercas 20,8mm 3/4" Euroconus	Tuercas: Cromado Biconos: Latón	29,62	
1			30004035	Juego de 2 adaptadores cromados para tubería de Hierro 1/2" Hierro - 3/4" Euroconus	Cromado	25,44	
			30004036	Juego de 2 adaptadores blancos para tubería de Hierro 1/2" Hierro - 3/4" Euroconus	Blanco	25,44	
1 B			30004093	Tuerca cromada doble para válvulas 50mm 1/2" Hierro 3/4" Euroconus	Cromado	39,79	

TIPO	IMAGEN	DATOS TÉCNICOS	REFERENCIA	DESCRIPCIÓN	ACABADO	PVP €
17			39501130	Kit cubre tubo con 2 rosetas Ø38mm y 2 tubos L= 70mm x Ø18mm	Cromado	26,85
			30004241	Kit cubre tubo con 2 rosetas Ø38mm y 2 tubos L= 70mm x Ø18mm	Blanco	26,85
			39501117	Kit cubre tubo con 2 rosetas Ø38mm y 2 tubos L= 70mm x Ø18mm	Rame Acidato	37,53
			39501118	Kit cubre tubo con 2 rosetas Ø38mm y 2 tubos L= 70mm x Ø18mm	Ottone Acidato	37,53
			39501119	Kit cubre tubo con 2 rosetas Ø38mm y 2 tubos L= 70mm x Ø18mm	Aluminio	37,53
			39501120	Kit cubre tubo con 2 rosetas Ø38mm y 2 tubos L= 70mm x Ø18mm	Inox Satinado	37,53
20			30004067	Juego de 2 rosetas de plástico Ø45mm para tubo de Ø1/2"	Blanco	3,51
		30004068	Juego de 2 rosetas de plástico Ø45mm para tubo de Ø1/2"	Cromado	7,47	
21			30004069	Juego de 2 rosetas de plástico Ø45mm para tubo de Ø10mm	Blanco	3,82
		30004070	Juego de 2 rosetas de plástico Ø45mm para tubo de Ø10mm	Cromado	7,47	
22			30004071	Juego de 2 rosetas de plástico Ø45mm para tubo de Ø12mm	Blanco	3,51
		30004072	Juego de 2 rosetas de plástico Ø45mm para tubo de Ø12mm	Cromado	7,47	
23			30004073	Juego de 2 rosetas de plástico Ø45mm para tubo de Ø14mm	Blanco	3,51
		30004074	Juego de 2 rosetas de plástico Ø45mm para tubo de Ø14mm	Cromado	7,47	
24			30004075	Juego de 2 rosetas de plástico Ø45mm para tubo de Ø15mm	Blanco	3,51
		30004076	Juego de 2 rosetas de plástico Ø45mm para tubo de Ø15mm	Cromado	7,47	
25			30004077	Juego de 2 rosetas de plástico Ø45mm para tubo de Ø16mm	Blanco	3,51
		30004078	Juego de 2 rosetas de plástico Ø45mm para tubo de Ø16mm	Cromado	7,47	
26			30004079	Juego de 2 rosetas de plástico Ø45mm para tubo de Ø18mm	Blanco	3,51
		30004080	Juego de 2 rosetas de plástico Ø45mm para tubo de Ø18mm	Cromado	7,47	

# Piezas de recambio

TIPO	IMAGEN	DATOS TÉCNICOS	REFERENCIA	DESCRIPCIÓN	ACABADO	PVP €
27			30004082	T de conexión 65 mm	Cromado	23,19
			30004081	T de conexión 65 mm	Blanco	22,24
			353118	T de conexión corta 50 mm	Cromado	25,75
			10002198	T de conexión corta 50 mm	Blanco	25,75
			49500518	Purgador orientable 1/4"	Cromado	4,14
			49501684	Purgador orientable 1/4"	Blanco	4,14
			49506389	Purgador orientable 1/2"	Cromado	4,14
			49501686	Purgador orientable 1/2"	Blanco	4,14
Tipo 8			30004048	Juego de 2 biconos para tubo de cobre de 15 mm	Latón	8,99
Tipo 14			30004043	Juego de 2 biconos para tubo de multicapa 12-16 mm	Latón	11,64
			40005383	Cabezal manual (pomo)	Blanco	4,74
			30004034	Cabezal manual (pomo)	Cromado	9,02
			30004037	Juego de 2 tuercas 3/4" Euroconus - Ø16.8 mm	Blanco	14,07
			30004038	Juego de 2 tuercas 3/4" Euroconus - Ø16.8 mm	Cromado	14,07
			30004039	Juego de 2 tuercas 3/4" Euroconus - Ø16.8 mm	Rame Acidato	18,80
			30004040	Juego de 2 tuercas 3/4" Euroconus - Ø16.8 mm	Ottone Acidato	19,27
			30004041	Juego de 2 tuercas 3/4" Euroconus - Ø16.8 mm	Aluminio	19,27
			30004042	Juego de 2 tuercas 3/4" Euroconus - Ø16.8 mm	Inox Satinado	19,27
			30003697	Caña para válvulas monotubo tipo J, K, M, N	Blanco	3,19
			30003698	Difusor para válvulas monotubo tipo J, K, M	Blanco	3,19
			30003701	Difusor para válvula monotubo tipo N	Blanco	3,19







# Corrección de emisiones

## FACTORES DE CORRECCIÓN

Factores de corrección f, de las emisiones de los diferentes modelos para saltos térmicos  $\Delta t$  diferentes de 50 K.

El salto térmico  $\Delta t$  es la diferencia entre la media de temperaturas de entrada y salida del radiador y la temperatura ambiente.

Salto térmico normalizado  $\Delta t_n$ :

Entrada 75 °C, Salida 65 °C, Ambiente 20 °C =  $(75 + 65)/2 - 20 = 70 - 20 = \Delta t_n$  50K.

n = Exponente de la curva característica.

## EXPONENTES

$\Delta t$ K	n = 1,20	n = 1,21	n = 1,22	n = 1,23	n = 1,24	n = 1,25	n = 1,26	n = 1,27	n = 1,28	n = 1,29
60	1,2446	1,2468	1,2491	1,2514	1,2537	1,2560	1,2583	1,2606	1,2629	1,2652
58	1,1949	1,1967	1,1985	1,2003	1,2021	1,2039	1,2056	1,2074	1,2092	1,2110
56	1,1457	1,1470	1,1483	1,1496	1,1509	1,1522	1,1535	1,1548	1,1561	1,1574
54	1,0968	1,0976	1,0984	1,0993	1,1001	1,1010	1,1018	1,1027	1,1035	1,1044
52	1,0482	1,0486	1,0490	1,0494	1,0498	1,0502	1,0507	1,0511	1,0515	1,0519
50	1,0000	1,0000	1,0000	1,0000	1,0000	1,0000	1,0000	1,0000	1,0000	1,0000
48	0,9522	0,9518	0,9514	0,9510	0,9506	0,9503	0,9499	0,9495	0,9491	0,9487
46	0,9048	0,9040	0,9033	0,9025	0,9018	0,9010	0,9003	0,8995	0,8988	0,8980
44	0,8578	0,8567	0,8556	0,8545	0,8534	0,8523	0,8512	0,8501	0,8491	0,8480
42	0,8112	0,8098	0,8084	0,8070	0,8056	0,8042	0,8028	0,8014	0,8000	0,7986
40	0,7651	0,7634	0,7617	0,7600	0,7583	0,7566	0,7549	0,7532	0,7515	0,7499
38	0,7194	0,7174	0,7155	0,7135	0,7116	0,7096	0,7077	0,7057	0,7038	0,7019
36	0,6742	0,6720	0,6698	0,6676	0,6654	0,6632	0,6611	0,6589	0,6567	0,6546
34	0,6295	0,6271	0,6247	0,6223	0,6199	0,6175	0,6151	0,6128	0,6104	0,6080
32	0,5854	0,5827	0,5801	0,5776	0,5750	0,5724	0,5699	0,5673	0,5648	0,5623
30	0,5417	0,5390	0,5362	0,5335	0,5308	0,5281	0,5254	0,5227	0,5200	0,5174
28	0,4987	0,4958	0,4929	0,4901	0,4873	0,4844	0,4816	0,4788	0,4761	0,4733
26	0,4563	0,4533	0,4503	0,4474	0,4445	0,4416	0,4387	0,4358	0,4330	0,4302
24	0,4145	0,4114	0,4084	0,4054	0,4025	0,3995	0,3966	0,3937	0,3908	0,3880
22	0,3734	0,3703	0,3673	0,3643	0,3613	0,3584	0,3554	0,3525	0,3496	0,3468
20	0,3330	0,3300	0,3270	0,3240	0,3210	0,3181	0,3152	0,3123	0,3095	0,3067

## EXPONENTES

$\Delta t$ K	n = 1,30	n = 1,31	n = 1,32	n = 1,33	n = 1,34	n = 1,35	n = 1,36	n = 1,37	n = 1,38	n = 1,40
60	1,2675	1,2698	1,2721	1,2744	1,2767	1,2791	1,2814	1,2837	1,2861	1,2908
58	1,2128	1,2146	1,2164	1,2182	1,2200	1,2219	1,2237	1,2255	1,2273	1,2310
56	1,1587	1,1600	1,1614	1,1627	1,1640	1,1653	1,1666	1,1680	1,1693	1,1719
54	1,1052	1,1061	1,1069	1,1078	1,1086	1,1095	1,1103	1,1112	1,1121	1,1138
52	1,0523	1,0527	1,0531	1,0535	1,0540	1,0544	1,0548	1,0552	1,0556	1,0564
50	1,0000	1,0000	1,0000	1,0000	1,0000	1,0000	1,0000	1,0000	1,0000	1,0000
48	0,9483	0,9479	0,9475	0,9472	0,9468	0,9464	0,9460	0,9456	0,9452	0,9445
46	0,8973	0,8965	0,8958	0,8950	0,8943	0,8935	0,8928	0,8921	0,8913	0,8898
44	0,8469	0,8458	0,8447	0,8436	0,8426	0,8415	0,8404	0,8393	0,8383	0,8361
42	0,7972	0,7958	0,7944	0,7930	0,7917	0,7903	0,7889	0,7875	0,7861	0,7834
40	0,7482	0,7465	0,7449	0,7432	0,7416	0,7399	0,7382	0,7366	0,7350	0,7317
38	0,6999	0,6980	0,6961	0,6942	0,6923	0,6904	0,6885	0,6866	0,6847	0,6810
36	0,6524	0,6503	0,6482	0,6460	0,6439	0,6418	0,6397	0,6376	0,6355	0,6313
34	0,6057	0,6034	0,6011	0,5987	0,5964	0,5941	0,5919	0,5896	0,5873	0,5828
32	0,5598	0,5573	0,5548	0,5524	0,5499	0,5474	0,5450	0,5426	0,5402	0,5354
30	0,5148	0,5121	0,5095	0,5069	0,5043	0,5018	0,4992	0,4967	0,4941	0,4891
28	0,4706	0,4679	0,4652	0,4625	0,4598	0,4571	0,4545	0,4519	0,4493	0,4441
26	0,4274	0,4246	0,4218	0,4191	0,4163	0,4136	0,4109	0,4082	0,4056	0,4003
24	0,3851	0,3823	0,3795	0,3767	0,3740	0,3713	0,3685	0,3658	0,3632	0,3579
22	0,3439	0,3411	0,3383	0,3356	0,3328	0,3301	0,3274	0,3247	0,3221	0,3168
20	0,3039	0,3011	0,2983	0,2956	0,2929	0,2903	0,2876	0,2850	0,2824	0,2773

# Condiciones generales de venta y entrega de Zehnder Group Ibérica I.C. SAU

## 0.- PREVIO

---

Las presentes condiciones generales de venta serán aplicables a aquellos CLIENTES que actúen como empresarios o profesionales, o que estén vinculados a empresas a las que pertenezcan. Se entenderá en ese caso que serán aplicables las estipulaciones recogidas en el Código de Comercio, y la relación comercial se entenderá como puramente comercial.

## 1.- GENERALES

---

A continuación, se detallan las Condiciones Generales de Venta (en adelante, las "Condiciones") que regulan la compraventa entre ZGES y usted (en adelante el Cliente), de los productos de ZGES.

Todas las ventas se realizan en las condiciones relacionadas a continuación, las cuales son aceptadas por el Cliente desde el momento de cursar el pedido por cualquier medio, sin perjuicio de las condiciones particulares que en su caso pudieran ser aplicables al Cliente, que previo acuerdo con ZGES, serán siempre formalizadas por escrito.

## 2.- PEDIDOS

---

La venta se formaliza cuando ZGES acepte el pedido mediante el envío de la correspondiente confirmación de pedido por e-mail. La realización de un pedido por parte del Cliente no constituye un contrato, aunque ZGES, haya presentado previamente una oferta. Sólo existirá contrato cuando conste una confirmación expresa y por escrito por parte de ZGES, y así cualquier acuerdo complementario y/o modificación posterior solicitada por el Cliente, deberá ser siempre confirmada y no surtirá efecto hasta que no haya aceptación expresa y escrita de ZGES.

Los cambios y las cancelaciones de los pedidos son gratuitos para los Clientes sólo si el pedido aún no ha sido tramitado.

Los pedidos urgentes que se transmiten de inmediato a producción nunca pueden ser modificados.

Las ilustraciones, las dimensiones, los pesos y los esquemas estandarizados no suponen ningún compromiso y pueden sufrir variaciones durante su fabricación. Se reserva el derecho de modificaciones de fabricación. Los materiales pueden ser sustituidos por otros equivalentes de idéntica calidad.

ZGES se reserva todos los derechos sobre los proyectos, los diseños, las documentación técnica y el software proporcionados al Cliente. El Cliente reconoce tales derechos y se compromete a no difundir, en todo o en parte, dicha documentación y dicho software a terceros sin la previa autorización escrita de ZGES, así como a no utilizarlos para finalidades diversas por parte de aquellos para los cuales han sido entregados al Cliente.

## 3.- PRECIOS

---

Al efectuar el pedido, el Cliente es informado del precio del producto solicitado y de los gastos de envío y entrega, el plazo de vigencia de la oferta y del precio.

ZGES puede modificar los precios establecidos en cualquier momento y dará cuenta de los nuevos importes al Cliente, a fin de lograr la confirmación final del pedido.

Los valores indicados en la lista de precios de ZGES no incluyen los costes de portes, seguros, instalación ni impuestos.

Excepto aquello acordado de forma distinta por escrito, todos los precios deben entenderse como precio de venta público sin IVA, incluidos el embalaje estándar. Todos los importes por compras accesorias, como por impuestos, alquiler, seguros, autorizaciones para la exportación o la importación o de otro tipo, así como todas las certificaciones van a cargo del Cliente.

Los pagos deben ser realizados por parte del Cliente en el domicilio de ZGES en conformidad con las condiciones de pago acordadas; a tal pro-

pósito, el importe debe ser depositado completamente sin ninguna reducción por descuentos, gastos, impuestos, tasas, cargos, deberes o similares. Los gastos bancarios corren a cargo del Cliente.

ZGES se reserva la facultad de realizar adecuaciones de precios si:

- El plazo de entrega se prolonga por motivos ajenos a ZGES,
- El tipo o el volumen de la entrega sufren modificaciones
- Las condiciones normales de entrega sean modificadas después de la confirmación de pedido. Así como también, las entregas especiales; camión grúa, días festivos, ubicaciones especiales, entregas en domicilio... o cualquier otro motivo que suponga un incremento sobre los costes de entrega.

## 4.- CONDICIONES GENERALES DE PAGO.

---

Todos los importes debidos a ZGES deben ser pagados en 60 días a partir de la fecha de la factura siempre condicionado a la concesión de riesgo por la agencia aseguradora de cobros que utilice ZGES. Los plazos de pagos establecidos deben ser respetados, incluso si aparecen retrasos de cualquier género desde el momento de la salida del establecimiento. No está permitido reducir o retener o compensar pagos a causa de reclamaciones, créditos todavía no concedidos o reconveniones no reconocidas por ZGES. Los pagos se realizan incluso si faltan partes no esenciales que no perjudican el uso de la mercancía entregada o si se necesita algún tipo de intervención después de la entrega.

Si el Cliente no respeta el plazo de pago acordado, desde el momento del vencimiento acordado se acumulará por los retrasos de pago un interés de demora del 5% mensual, siendo de aplicación lo prescrito por el art 5 de la ley 3/2004 de 29 de diciembre, por la que se establecen medidas de lucha contra la morosidad en las operaciones comerciales. ZGES se reserva la vinculación de la entrega de los pedidos pendientes al pago de los créditos ya otorgados, así como la cancelación del contrato, reclamando la compensación por daños y pérdida de ingresos. Los plazos de pagos convenidos deben ser respetados, y los descuentos no autorizados serán cargados.

A partir de cierto volumen de pedido o en el caso de que el Cliente no tenga riesgo suficiente concedido por parte de la empresa aseguradora de cobros que ZGES utilice, podrá ser acordada la facturación de un 60% del importe del pedido como pago anticipado.

Si el Cliente no paga en la fecha de vencimiento acordada con ZGES éste podrá suspender sus entregas pendientes.

## 5.- PLAZOS DE ENTREGA

---

Las entregas sólo se realizan a destinos de España Peninsular, Baleares, Portugal y Andorra.

Para consultar el plazo de entrega, a partir de la confirmación del pedido, puede dirigirse a nuestro servicio de atención al cliente a través del correo [info@zehnder.es](mailto:info@zehnder.es) adjuntando el documento de confirmación de pedido. El albarán de entrega será remitido junto con el Producto o Productos.

En ningún caso se incluye la instalación y/o la sustitución de los productos por parte de ZGES.

En el caso que haya algún error en la dirección de entrega especificada por el cliente en el pedido, ZGES no se compromete a mantener las condiciones especificadas en el pedido inicial: plazo de entrega, disponibilidad, gastos de envío.

ZGES en ningún caso se responsabilizará de la pérdida del material entregado en la dirección de envío especificada en el pedido.

El cliente se responsabilizará de revisar detenidamente la mercancía en el momento de la entrega. En el caso de que se perciba algún daño en el embalaje de entrega, esta mercancía debe de ser rechazada o, en su defecto, hacer constar este incidente en el albarán de entrega, que se entregará al transportista en el momento de la entrega. Posteriormente el cliente debe ponerse en contacto con el departamento de atención al cliente mediante un email a la dirección [info@zehnder.es](mailto:info@zehnder.es) para comunicar la incidencia dentro del plazo de 48 horas.

No se aceptarán incidencias de transporte si el cliente no ha dejado constancia del incidente en el albarán de entrega (entregado al transportista) o no ha rechazado completamente la entrega. Un albarán firmado y/o sellado sin ninguna notificación de incidencia significa que la mercancía ha sido recepcionada en perfectas condiciones.

Una vez se ha recibido la mercancía, el cliente tiene un plazo de 48h para abrir el embalaje y comunicar a ZGES a través del email [info@zehnder.es](mailto:info@zehnder.es) cualquier desperfecto que pueda identificar. ZGES evaluará la incidencia y se reserva el derecho de aceptar o no la incidencia.

- En los casos siguientes, el plazo de entrega se amplía en la medida adecuada y el Cliente no tiene derecho a indemnización por daños o rescisión del contrato por retraso en la entrega:

- si ZGES no hubiera recibido las informaciones oportunas necesarias para la ejecución del pedido o si la información ha sido modificada en una fecha posterior por el Cliente, provocando un retraso en la entrega;

- si se encuentra con obstáculos fuera de control de las partes interesadas, tales como pandemias, guerras, disturbios, anomalías de funcionamiento relevantes, accidentes, conflictos laborales, la entrega tardía o defectuosa de las materias primas, los productos semielaborados o terminados necesarios, decisiones de las autoridades o eventos naturales. Una vez verificado un obstáculo de este tipo, cada parte deberá informar rápidamente a la otra parte.

## 6.-TRANSPORTES

Los costes de transporte están incluidos en los precios del producto excepto cuando:

- El valor neto de la entrega sea inferior a 250€: Coste del transporte 25€.

- Las condiciones de entrega sean especiales como las indicadas en el punto 3: Coste del transporte a confirmar.

## 7.- GARANTÍA

ZGES garantiza el funcionamiento de todos y cada uno de sus productos respecto cualquier defecto en los materiales y mano de obra empleados en su fabricación. La garantía comercial de ZGES se extiende durante los tres años posteriores a la fecha de entrega del producto que será la que se haga constar en el albarán de entrega.

Los consumibles tendrán una garantía efectiva de 6 meses desde su fecha de entrega.

El alcance de la garantía de ZGES incluye todo el territorio nacional, Andorra y Portugal. Para cualquier reclamación en relación con ésta, se deberá tramitar la correspondiente reclamación a nuestro Departamento Comercial. ZGES evaluará la información facilitada y no aceptará por garantía los casos que no sean claramente defecto de fabricación.

ZGES concede la garantía sobre los dispositivos de terceros sólo en el ámbito de las obligaciones de la garantía de los subcontratistas.

Una vez comunicado a ZGES este será reparado, cambiado o en su defecto sustituido por otro idéntico o similar. La recogida del material defectuoso irá a cargo de ZGES. Las piezas sustituidas pasan a ser propiedad de ZGES.

Se excluyen expresamente todas las reclamaciones de indemnización realizadas por el Cliente por daños y perjuicios derivados de la propia entrega, como la compensación por la pérdida de producción, la pérdida de beneficios, la pérdida de puestos de trabajo, la pérdida de ingresos, las reclamaciones de terceros o cualquier reclamación por daños indirectos o consecuentes, independientemente de la base jurídica en virtud de que tales daños sean reclamados. La responsabilidad de ZGES con o en relación con el contrato o de la ejecución inadecuada está limitada en su extensión al precio pagado por el Cliente por la entrega realizada.

La garantía no será aplicable en los siguientes supuestos:

- Los daños han sido causados por fuerza mayor.

- Si la instalación y/o montaje del producto no se han realizado conforme a las instrucciones que acompañan al producto, y por personal técnico especializado.

- Si el producto se ha expuesto a cargas mecánicas no conformes a su uso previsto.

- En lo referente a los equipos electrónicos, si el producto no se ha instalado conforme a las especificaciones IEC correspondientes en vigor, en el momento de la adquisición.

- El incumplimiento de las directivas para el diseño, instalación, operación, uso y mantenimiento.

- Si el Cliente no conserva el producto que ha resultado defectuoso en el estado en que se encuentre durante todo el tiempo que sea necesario para que ZGES pueda llevar a cabo las comprobaciones necesarias en relación con los defectos/vicios encontrados.

- Si el Cliente no ha pagado regularmente el producto.

- Si el producto o alguna de sus partes han sido reparados, sustituidos, ajustados, sellados, o modificados por el Cliente o por terceros sin la autorización previa y por escrito de ZGES.

- Quedan igualmente excluidos de la garantía las piezas y los materiales de servicio sujetos a desgaste natural.

- También quedan excluidos: daños por corrosión (especialmente si están conectados a sistemas de tratamiento de agua, descalcificadores, etc. o sustancias anticongelantes inadecuadas), cualquier daño adicional causado por el agua agresiva, presiones excesivas, descalcificaciones inadecuadas o por influencias químicas o electrolíticas, a una excesiva solicitud, al uso de equipos de funcionamiento no adecuado o a otras causas no atribuibles a ZGES, etc.

- La garantía queda anulada si el sistema se vacía periódicamente o durante períodos prolongados, en caso de funcionamiento con vapor, adición de sustancias al agua de calefacción que puede ser agresivo para el material de acero o sellador, depósitos excesivos de barro en los radiadores, introducción continua o temporal de oxígeno en la planta.

## 8.-DEVOLUCIÓN DE PRODUCTOS

Por defecto, no se aceptan devoluciones de material. En casos excepcionales, y previamente aceptados por ZGES, se podrán aceptar devoluciones únicamente de materiales considerados de stock por ZGES. Para una devolución, es necesario cumplimentar y enviar el documento de solicitud de devolución de materiales (DMAT). La mercancía debe ser devuelta en su embalaje original, no manipulado y en perfectas condiciones con los manuales y accesorios originales. ZGES se reserva el derecho de aceptar o rechazar la devolución de material.

La gestión de devolución hasta que el material llegue a nuestros almacenes es responsabilidad del cliente: los gastos de manipulación, embalaje y transporte correrán siempre a cargo del Cliente. El abono del material sufrirá una depreciación del 15 %.

## 9.-RESERVA DE DOMINIO

La mercancía suministrada es propiedad de ZGES hasta su pago. Si este se efectúa por cheque, talón o giro bancario se considerará realizado en el momento en que se haga efectivo el documento comercial que se trate. El derecho de propiedad subsiste aún después de que el comprador haya revendido el producto, hasta que no haya cancelado la deuda.

## 10.-JURISDICCIÓN

Para cualquier discrepancia o litigio que se derive de las citadas Condiciones Generales de Venta, ambas partes se someten a la competencia de los Juzgados y Tribunales de Barcelona, con expresa renuncia a su fuero propio.

**zehnder**

studio  
collection



Encuétranos  
online

**Zehnder Group Ibérica**  
Raimon Casellas 131  
08205 Sabadell · España  
T +34 900 700 110  
[info@zehnder.es](mailto:info@zehnder.es)  
[www.zehnder.es](http://www.zehnder.es)